



website:<http://us.lge.com>

☎ 1-800-243-0000

24 HOURS A DAY, 7 DAYS A WEEK FOR LG CUSTOMER SERVICE
para el Servicio LG (Atención al Cliente) 24 horas al día, 7 días a la semana

LSC27990TT

SXS REFRIGERATOR

User's Guide

Please read this guide thoroughly
before operating and keep it handy
for reference at all times.

SXS REFRIGERATEUR

Manuel d'utilisation

Prière de lire attentivement le présent manuel
avant d'utiliser le réfrigérateur.
Conserver à portée de main pour pouvoir le
consulter à tout moment.

FRIGORÍFICO **SXS**

Guía de usuario

Lea detenidamente estas instrucciones
antes utilizar el frigorífico y guárdelas
como referencia para el futuro.

Table of Contents

Introduction	Entry	3
	Important safety instructions	3
	Identification of parts	4
Installation	Where to install	5
	Door removal	6
	Install the freezer and refrigerator compartment doors	7
	Water supply installation	7
	Water connection instruction guide	8
	Height adjustment	11
	External Equipment Connections	12
Operation	Setup	13
	Adjusting the temperatures and functions	13
	Temperature	14
	Dispenser	15
	Menu	16
	Shelf	37
	Humidity control in the vegetable compartment	37
	OptiFresh temperature bin	38
	OptiFresh	38
Suggestion on food storage	Location of foods	39
	Storing foods	40
Care and maintenance	How to remove and replace parts	41
	General information	44
	Cleaning	44
	Troubleshooting	45
	Warranty	50
	Zip code	151

Entry

The model and serial numbers are found on the inner case or back of refrigerator compartment of this unit. These numbers are unique to this unit and not available to others. You should record requested information here and retain this guide as a permanent record of your purchase. Staple your receipt here.

Date of purchase _____
 Dealer _____
 Dealer address _____
 Dealer phone _____
 Model _____
 Serial _____

Important safety instructions

Before use, this refrigerator must be properly installed and located in accordance with the installation instructions in this manual.

Never unplug your refrigerator by pulling on the power cord. Always grip the plug firmly and pull it straight out from the outlet.

When moving your appliance away from the wall, be careful not to roll over the power cord or to damage it in any way. Do not crush or damage the water line.

After your refrigerator is in operation, do not touch the cold surfaces in the freezer compartment, particularly when your hands are damp or wet. Skin could adhere to these extremely cold surfaces.

Unplug the power cord from the power outlet for cleaning or other requirements. Never touch it with wet hands because you can get an electric shock or be injured.

Never damage, bend, kink, pull out, or twist the power cord because damage to the power cord can cause product failure, fire, or electric shock. If you have doubts the appliance is properly grounded, consult a qualified electrician.

Never place glass products in the freezer because they may be broken from expansion when their contents are frozen.

Never put your hands within the ice storage bin of the automatic icemaker. You can be injured by the operation of the automatic icemaker.

The appliance is not intended for use by young children without supervision.

Young children should be supervised to ensure that they do not play with the appliance.

Never allow anyone to climb, sit, stand, or hang on the door. These actions may damage the refrigerator and even tip it over, causing severe personal injury.

Before you move your refrigerator into its final location, it is important to make sure you have the proper electrical connection.

A 115 Volt, 60 Hz., AC only, 15 or 20 amp, fused and grounded single-outlet circuit is required. Use an outlet that cannot be turned off by a switch. Do not use an extension cord.

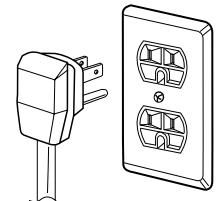

The refrigerator-freezer should be so positioned that the supply plug is accessible for quick disconnection in the event of an emergency.

If the supply cord is damaged, it must be replaced by the manufacturer or its service agent or a similarly qualified person in order to avoid any hazard.

Do not modify or extend the Power Cord length.

- It may cause electric shock or fire.



**Recommended
grounding
method**

**Accessibility of
supply plug**

**Supply cord
replacement**

⚠ Warning

Child entrapment warning**DANGER: Risk of child entrapment.**

Before you throw away your old refrigerator or freezer take off the doors but leave the shelves in place so that children may not easily climb inside.

The appliance is not intended for use by young children without supervision.

Young children should be supervised to ensure that they do not play with the appliance.

Don't store

Don't store or use gasoline or other flammable vapor and liquids in the vicinity of this or any other appliance.

Grounding

In the event of an electric short circuit, grounding (earthing) reduces the risk of electric shock by providing an escape wire for the electric current.

In order to prevent possible electric shock, this appliance must be grounded.

Improper use of the grounding plug can result in an electric shock. Consult a qualified electrician or service person if the grounding instructions are not completely understood, or if you have doubts on whether the appliance is properly grounded.

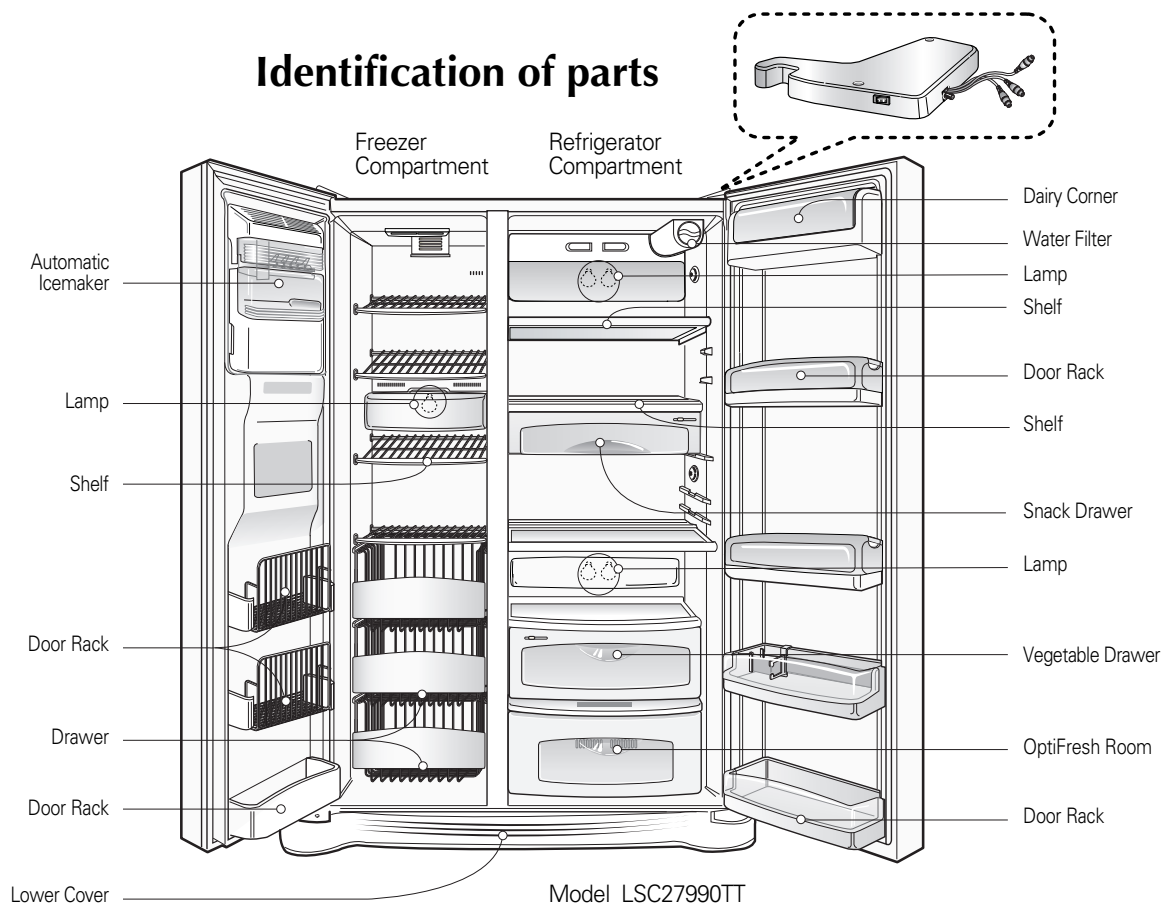
Identification of parts**NOTE**

- Parts, features, and options vary by model. Your model may not include every option.

Where to install

Strong and even floor

Unstable installation may cause vibration and noise. If the floor to install the refrigerator on is not even, make the refrigerator level by rotating the height adjusting screw.

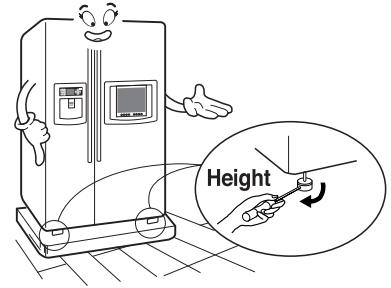

A proper distance from adjacent items

Please keep the refrigerator at a proper distance from other things. Too small a distance from adjacent items may result in lowered freezing capability and increased electricity charges consumption.

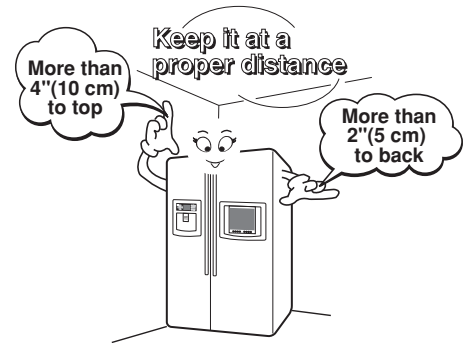

Where water supply can be easily connected in a dry place

Select a place where a water supply can be easily connected between the automatic ice maker and dispenser. Installing the refrigerator in a wet or damp area may cause rust and may be an electrical hazard.

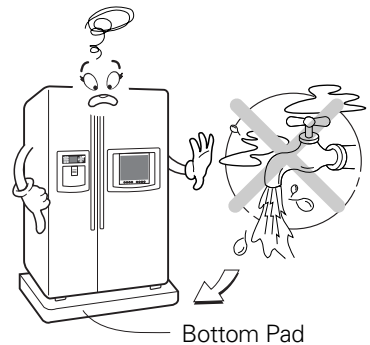

Where it is free from heat

If this refrigerator is installed where the ambient temperature is high, the freezing capacity is deteriorated and the cost of electricity used increases.

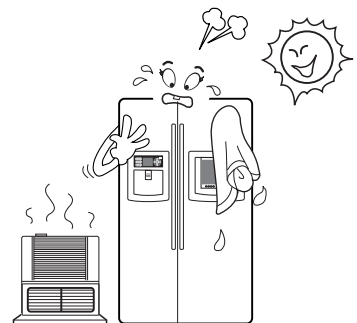

NOTE

- Install the refrigerator at a place where the ambient temperature is 5°C ~ 43°C (41°F~110°F). Ambient temperature outside this range may cause product malfunction. Also, the tube between the dispenser and automatic ice maker may freeze.

Door removal

Warning

Electric Shock Hazard

Disconnect electrical supply to refrigerator before installing. Failure to do so could result in death or serious injury.

If your entrance door is too narrow for the refrigerator to pass through, remove the refrigerator door and pass the refrigerator laterally.

Remove the lower cover by lifting upward, and then pull up the water feed tube while pressing the release ring ① shown in the figure to the right.

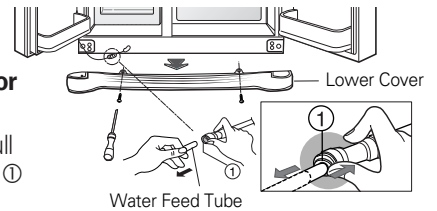

Remove lower cover and water feed tube

NOTE

- If a tube end is deformed or abraded, trim the part away. Disconnecting the tube under the door causes about 1/2 gallon (2 liters) water to flow out. Please put up a big container to prevent it.

Remove the freezer compartment door

1) Remove the hinge cover by loosening the screws. Disconnect all connections except the ground line.



2) Remove the keeper by rotating it counter clockwise ① and then lifting the upper hinge up ②.

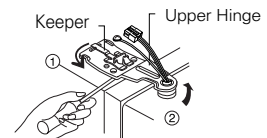

NOTE

- When removing the upper hinge, be careful that the door does not fall forward.

3) Remove the freezer compartment door by lifting it upward. This time, the door should be lifted enough for the water feed tube to be completely pulled out.

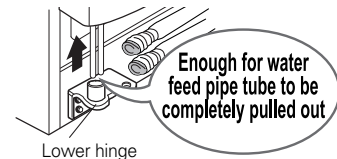

NOTE

- After removing the door, take it into the kitchen where you are installing the refrigerator. Lay it down on a blanket and be careful to avoid damaging the water feed tube.

Remove the refrigerator door

1) Loosen the hinge cover screws and remove the cover. Remove connection wire, if any, except for the ground line.

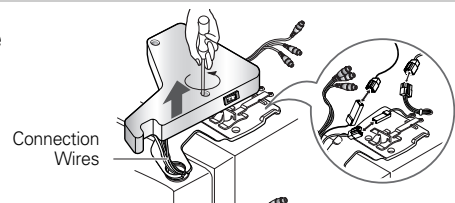

2) Remove keeper by rotating it clockwise (①) and then remove the upper hinge by lifting it up (②).

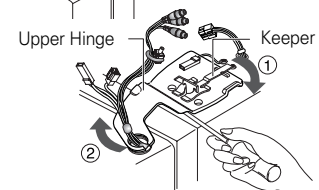

3) Remove the refrigerator compartment door by lifting it up.

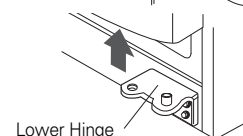

Pass the refrigerator

Pass the refrigerator laterally through the access door as shown in the right figure.

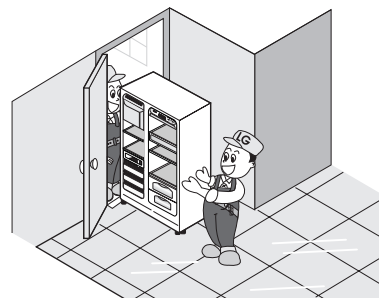

Install the freezer and refrigerator compartment doors

Mount them in the reverse sequence of removal after they pass through the access door.

Water supply installation

Before installation

- Automatic icemaker operation needs water pressure of 21~121 psi (1.5~8.5 kgf/cm²) (That is, an instant paper cup (6 oz. or 180 cc) will be fully filled within 3 seconds.)
- If water pressure is less than 21 psi (1.5 kgf/cm²). It is necessary to purchase a separate pressure pump for normal automatic icemaking and cool water feed.
- Keep the total length of the feed water pipe tube within 26' (8 m). Be careful for the tube to avoid being kinked. If the tube is longer than 26' (8 m), the pressure may drop to an unacceptable level.
- Install the water supply line where it will not be affected by heat.

Warning

- Connect to potable water supply only.

Disposal of the old appliance

This appliance contains fluids (refrigerant and lubricant) and is made of parts and materials which are reusable and/or recyclable. All the important materials should be sent to the collection center of waste material and can be reused after rework (recycling). For recycling, please contact the local agency.

Water connection instruction guide

Connecting the refrigerator to a water source

 **Warning**

Read all directions carefully before you begin.

Connect to potable water supply only.

IMPORTANT

- If operating the refrigerator before installing the water connection, turn the icemaker to the **OFF** position to prevent operation without water.
- All installations must be in accordance with local plumbing code requirements.
- Use copper tubing and check for leaks.
- Install copper tubing only in areas where temperatures will remain above freezing.
- It may take up to 24 hours for your icemaker to begin producing ice.

Tools required

- Standard screwdriver
- 7/16-inch and 1/2-inch open-end wrenches or two adjustable wrenches
- 1/4-inch nut driver
- 1/4-inch drill bit
- Hand drill or electric drill (properly grounded)

NOTE

- Your refrigerator dealer has a kit available with a 1/4-inch saddle-type shut-off valve, a union, and copper tubing. Before purchasing, make sure a saddle-type valve complies with your local plumbing codes. Do not use a piercing-type or 3/16-inch saddle valve which reduces water flow and clogs more easily.

Cold water supply

The icemaker water valve contains a flow washer which is used as a water pressure regulator.

The icemaker needs to be connected to a cold water line with water pressure 21 psi (lb/inch²)

Connect the tubing to water line

1. Unplug the refrigerator or disconnect power.
2. Turn OFF the main water supply. Turn on the nearest faucet to relieve the pressure on the line. It may help to open an outside faucet to allow the water to drain from the line in the house.
3. Find a 1/2-inch vertical COLD water pipe near the refrigerator.

NOTE

- Horizontal pipe will work, but the following precaution must be taken: Drill on the top of the pipe, not the bottom. This will help keep water away from the drill. This also keeps normal sediment from collecting in the valve.

4. To determine the length of copper tubing you will need, measure from the connection on the lower left rear of the refrigerator to the water pipe. Add 7 feet (2.1m) to allow for moving refrigerator for cleaning. Use 1/4-inch O.D. (outside diameter) copper tubing. Be sure both ends of copper tubing are cut square.
5. Using a drill, drill a 1/4-inch hole in the cold water pipe you have selected.
6. Fasten shut-off valve to cold water pipe with pipe clamp. Be sure the outlet end is solidly in the 1/4" drilled hole in the water pipe and the washer is under the pipe clamp. Tighten the packing nut. Tighten the pipe clamp screws carefully and evenly so the washer makes a watertight seal. Do not overtighten or you may crush the copper tubing, especially if soft (coiled) copper tubing is used. Now you are ready to connect the copper tubing.
7. Slip the compression sleeve and the compression nut onto the copper tubing as shown. Insert the end of the tubing into the outlet end squarely as far as it will go. Tighten the compression nut onto the outlet end with a wrench. A flare nut wrench works best, but an open end wrench will suffice. Do not overtighten.
8. Place the free end of the tubing into a container or sink, and turn on the main water supply. Flush out the tubing until the water is clear. Turn off the shutoff valve on the water pipe. Coil the copper tubing as shown below.

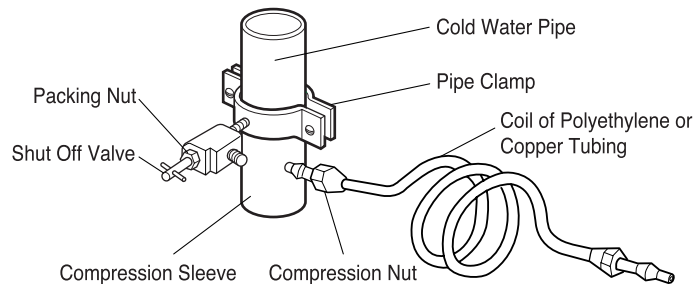

Connect the tubing to the refrigerator

Before making the connection to the refrigerator, be sure the refrigerator power cord is not plugged into the wall outlet.

- If your refrigerator does not have a water filter, we recommend installing one. If your water supply has sand or particles, that could clog the screen of the refrigerator's water valve. Install the filter in the water line near the refrigerator.

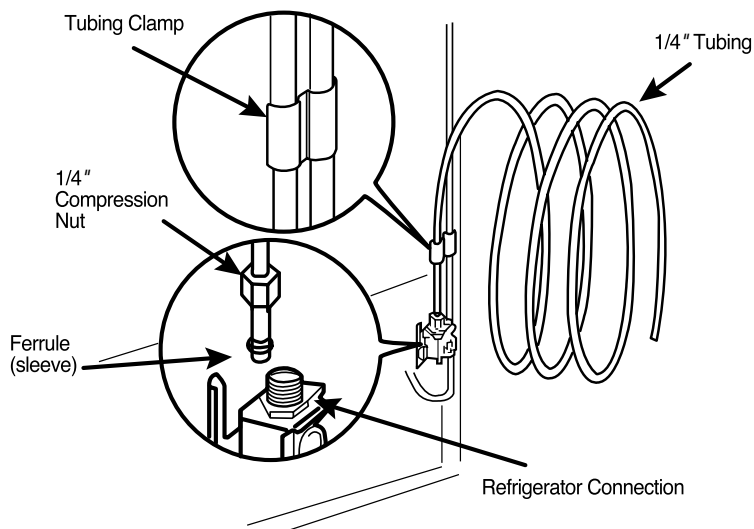

1. Remove the plastic flexible cap from the water valve.
2. Place the compression nut and ferrule (sleeve) onto the end of the tubing as shown.
3. Insert the end of the copper tubing into the connection as far as possible. While holding the tubing, tighten the fitting.

Turn the water on at the shutoff valve

Tighten any connections that leak.

■ Plug In the Refrigerator

Arrange the coil of copper tubing behind the refrigerator so it does not vibrate against the back of the refrigerator or against the wall. Push the refrigerator back to the wall.

■ Start the Icemaker

Set the icemaker switch to the ON position. The icemaker will not begin to operate until it reaches its operating temperature of 15 °F (-9 °C). It will then begin operation automatically.

Height adjustment

If the freezer compartment door is lower than the refrigerator compartment door

Level them by inserting a flat (- type) driver into the groove of the left height adjusting screw and rotating it clockwise (⌚).

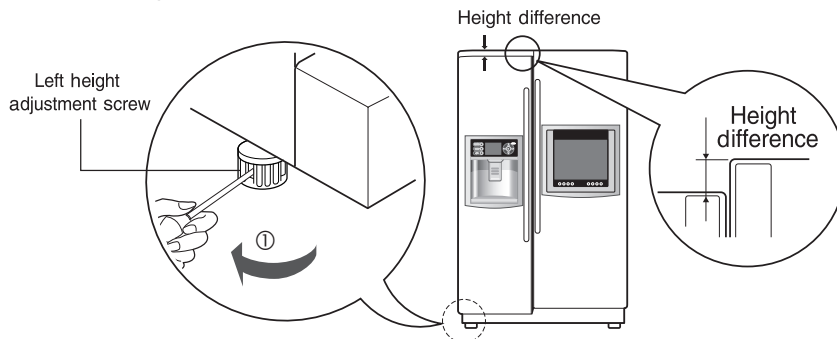

If the freezer compartment door is higher than the refrigerator compartment door

Level them by inserting a flat (- type) driver into the groove of the right height adjusting screw and rotating it clockwise (⌚).

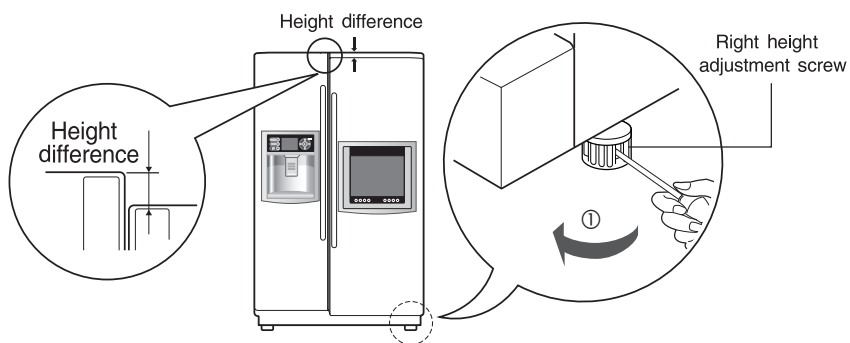

After leveling the door height

The refrigerator door will close smoothly by raising the front side by adjusting the height adjusting screw. If the door does not close properly because it is improperly adjusted, the performance of the refrigerator will be affected.

External Equipment Connections

Antenna Connection

- Antenna or Cable Service without a Cable Box Connections
- For optimum picture quality, adjust antenna direction if needed.

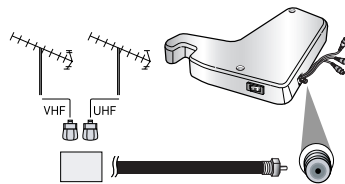
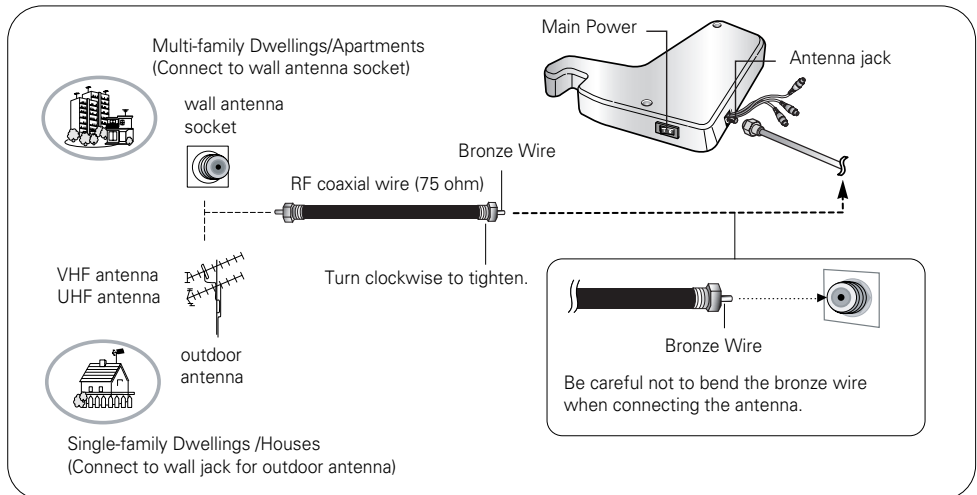

- In a poor signal area to improve picture quality, purchase and install a signal amplifier.
- If the antenna is not installed properly, contact your dealer for assistance.

Connecting a VCR / DVD

Connection

1. Connect the audio/video out sockets of the VCR to audio/video in sockets of the set.
2. Press the **TV/AV/RADIO** button to select **AV**.
3. Press the **PLAY** button on the VCR.
The VCR playback picture appears on the screen.

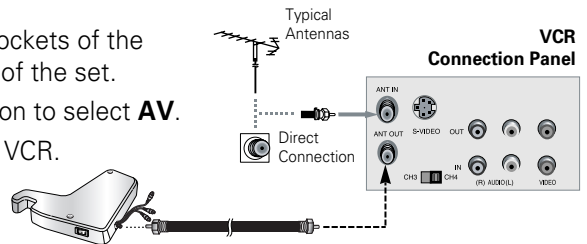

NOTE

- If you have a mono VCR, connect the audio cable from the VCR to the **AUDIO L/MONO** socket of the set.

Cable TV Connections

- After subscribing to a local TV service and installing a converter, you can watch cable TV programming.
- For further cable TV information, contact a local cable service provider.

Connection

1. Use the **TV/AV/RADIO** button on the remote control to select **TV**.
2. Tune to cable service provided channels using the cable box.

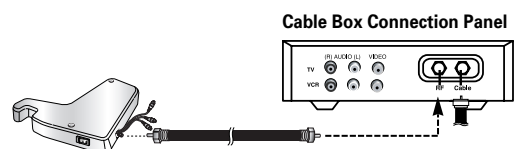

Setup

When your refrigerator is first installed, allow it to stabilize at normal operating temperatures 2~3 hours prior to filling it with fresh or frozen foods. If operation is interrupted, wait 5 minutes before restarting.

Adjusting the temperatures and functions

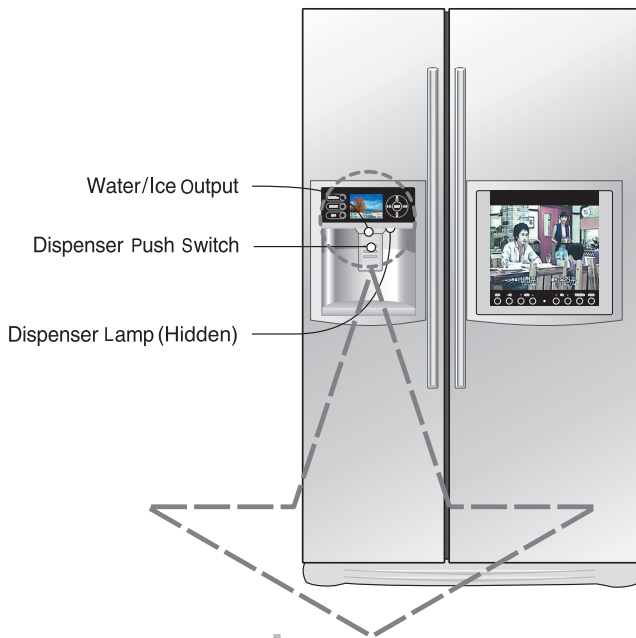

About defective pixels

This LCD display contains hundreds of thousands of individual pixels. LCD displays typically contain a small number of pixels that do not function normally. Your display has been inspected and is in compliance with manufacturer's specifications, indicating that any pixel defects do not affect the operation or use of your display. On a display of this size, 4 or fewer defective pixels are considered to be normal and are not grounds for exchange or refund.

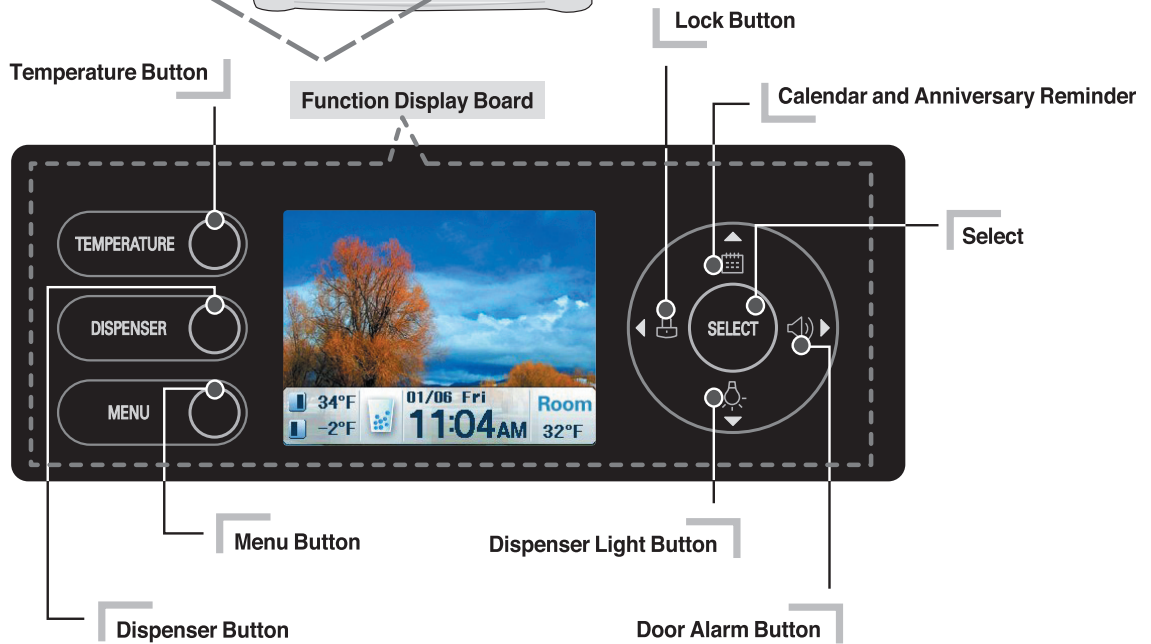

NOTE

- Your model may not include every option.

Temperature

Refrigerator/Freezer

- You can adjust the freezer and refrigerator temperature.

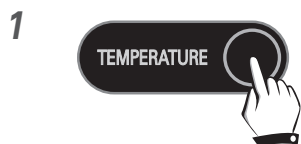

1 Press the **TEMPERATURE** button.

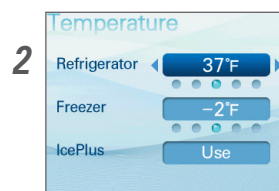

2 Using the ▲ or ▼ button, select the desired refrigerator.

3 Select the temperature using the ◀ or ▶ button.

Refrigerator temperature options: 46, 41, 37, 34, or 32°F

Freezer temperature options: 7, 1, -2, -5, or -8°F

4 Press the **SELECT** button.

5 Return to the standby screen.

IcePlus

- For quick freezing.

- The standby screen is shown during  IcePlus operation.

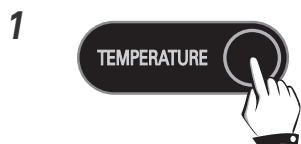

1 Press the **TEMPERATURE** button.

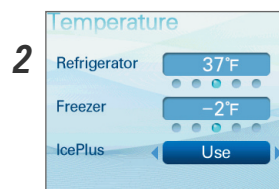

2 Press the ▲ or ▼ button to select **IcePlus**.

3 Press the ◀ or ▶ button to select **Use**. **[Use] <--> [Not in Use]**

4 Press the **SELECT** button.





5 **[Processing IcePlus!]**

6 Return to the standby screen.

- The indicated set temperature is not the actual temperature within the refrigerator but the target temperature. The actual internal temperature can differ, especially if the door is opened and warm food was recently stored.
- Initially the refrigeration is weak. Adjust the temperature as mentioned above after using the refrigerator for at least 2 to 3 days.

Dispenser

Crush/Water/Cube

- You can select from Crush, Water or Cube options.
- When the dispenser is in use, the active option is indicated in the standby screen.
- Crush , Water , Cube .



Press the **DISPENSER** button.

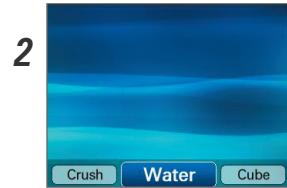

Select the desired option using the ◀ and ▶ buttons.

[Crush] <--> [Water] <--> [Cube]

3 Press the **SELECT** button.

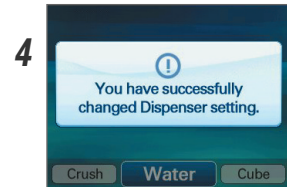

5 Return to the standby screen.

Automatic icemaker

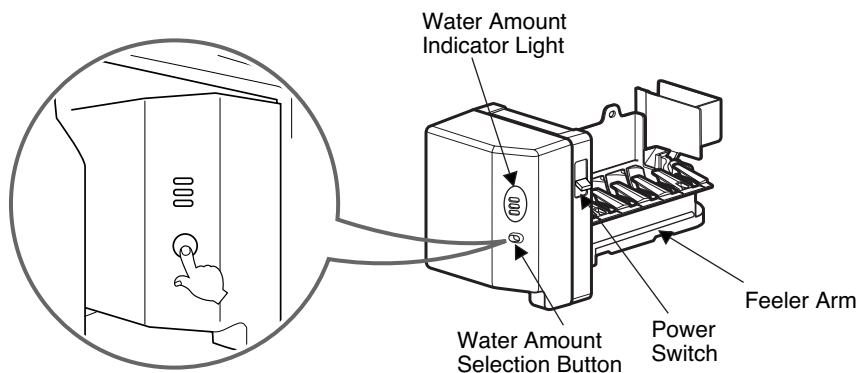

- The automatic icemaker can automatically make 6 cubes at a time, 70~120 pieces per day. This quantity may vary by circumstance, including ambient temperature, door opening, freezer load. etc.
- Icemaking stops when the ice storage bin is full.
- If you don't want to use the automatic icemaker, turn the icemaker switch to OFF. If you want to use automatic icemaker again, change the switch to ON.
- The water amount will vary depending on the water amount selection button. Setting, as well as the water pressure of the connected water line.

NOTE

- It is normal that a noise is produced when ice drops into the ice storage bin.

Menu

You can select from Information, Gourmet Recipes, Refrigerator, Settings, and Photo Album function.



Press the **MENU** button.



3 Select the menu using the ▲ and ▼ buttons.

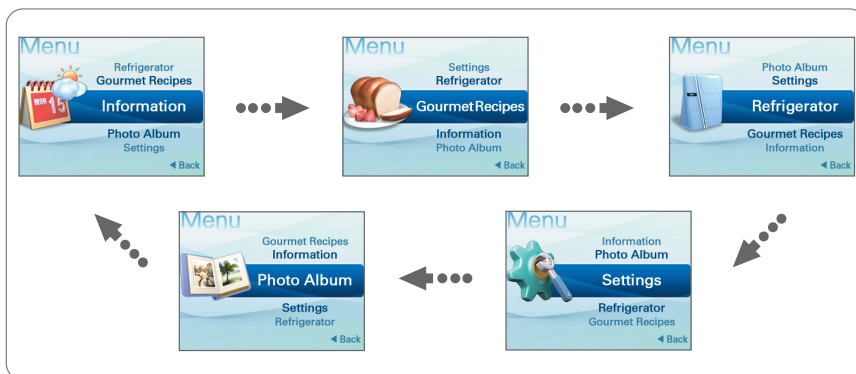

4 Press the **SELECT** button.

5 You will see the detail menu.

Information

You can select from Weather Forecast, Anniversary Reminder, Date and Time Setting, or Timer function.

☐ **Weather Forecast**

- Receives and displays the weather and temperature for 5 days, including the current day.
- Reception of weather forecast information received and displayed on the screen is subject to vary depending on your region and location of refrigerator.
- Thereby LG does not guarantee and will not be held responsible for accuracy of the weather information.
- Weather forecast information is only available in U.S.A



Press the ▲ or ▼ button to select **Weather Forecast**.

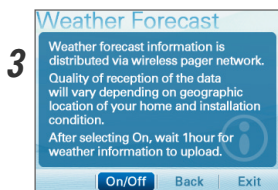

Press the ◀ or ▶ button to select **On/Off**.

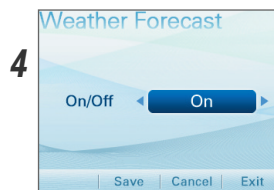

Press the ◀ or ▶ button to select **On**.



Select the desired region using the ◀ or ▶ button.



7 Return to the **Information** menu.

☐ **Anniversary Reminder**

- Register the anniversary date.
-  Select the Anniversary reminder using the button.

< **To set a new date >**



Press the ▲ or ▼ button to select **Anniversary Reminder**.



Select the month using the ◀ or ▶ button.

Press the ▼ button and then select the date using the ◀ or ▶ button.



Select the menu using the ▲ or ▼ button.

Select the advance time using the ◀ or ▶ button.



Press the ▼ button to select **Save**.

6 Return to the **Information** menu.

The anniversary reminder alarm goes off



The alarm will go off at the set date and time, and the anniversary will be displayed in the screen.

< To view the anniversary list >



Press the ▲ or ▼ button to select **Anniversary Reminder**.



Press the ▲ or ▼ button to select **List**.



You can check the detail menu using the ◀ or ▶ button.

□ **Data & Time Setting**

To set the date and time.



Press the ▲ or ▼ button to select **Date & Time Setting**.



Select the menu using the ▲ or ▼ button.

Select the value using the ◀ or ▶ button.



Press the ▼ button to select **Save**.

5 Return to the **Information** menu.

☐ **Timer**

To set the alarm.



Press the ▲ or ▼ button to select **Timer**.

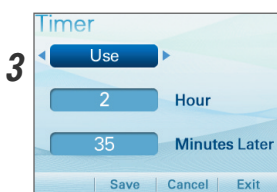

Select the time using the ◀ or ▶ button.

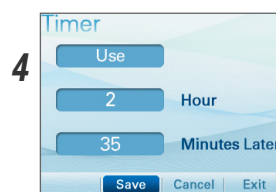

Press the ▼ button to select **Save**.

5 Return to the Information menu.

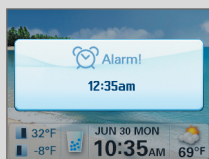

- The alarm will go off at the set time, and the timer image will be displayed in the screen.

Gourmet Recipes

Select the recipe after selecting the menu category of dish.



Select the menu category using the ▲ or ▼ button.



You can select the dish using the ◀ or ▶ button.



Press the ▼ button to select **More**.

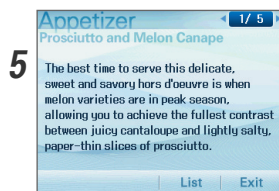

You can select the detail menu using the ◀ or ▶ button.

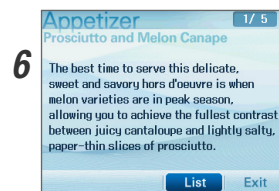

Press the ▼ button to select **List**.

7 Return to the **Gourmet Recipes** menu.

Refrigerator

You can select from Filter reset, Door alarm, Dispenser light, Manual, and Service Call functions.

❑ **Filter Reset**

Reminds you when to replace the filter.

< When the filter exchange date is still not due. >



Press the ▲ or ▼ button to select **Filter Reset**.



Press the ◀ or ▶ button to select **Reset**.

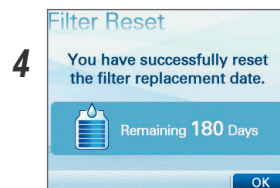

Press the **SELECT** button.

5 Return to **Refrigerator** menu.

< When the filter exchange date is overdue. >



Press the ▲ or ▼ button to select **Filter Reset**.



Press the ◀ or ▶ button to select **Reset**.

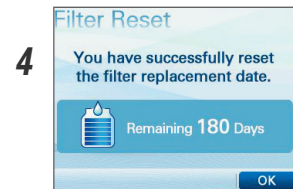

Press the **SELECT** button.

5 Return to **Refrigerator** menu.

- You will see a message notifying you how long it will be before you need to change the filter.



Press the ◀ or ▶ button to select **Reset**.



Press the **SELECT** button.

Return to the standby screen.

- If you choose to cancel filter exchange setting.

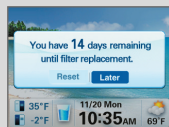

Press the ◀ or ▶ button to select **Later**.



You will see the filter exchange sign in the standby screen.

□ **Door Alarm**

This is the function of notifying you every 30 seconds that the refrigerator door is open for more than 1 minute.

-  You can turn the door alarm on or off.

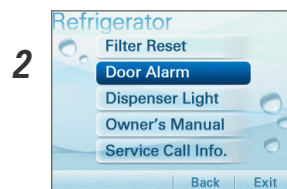

Press the ▲ or ▼ button to select **Door Alarm**.



Press the ◀ or ▶ button to select **Use** or **Not in Use**.



Press the ▼ button to select **Save**.

5 Return to the **Refrigerator** menu.

- You will see the door alarm message.

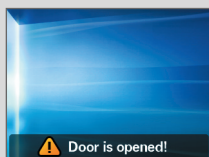

- **When using the Door Alarm**

This notifies you every 30 seconds that the refrigerator door is open for more than 1 minute.

- **When not using the Door Alarm**

The alarm will not go off even when the refrigerator door is open.

❑ **Dispenser Light**

This function controls the LED lamp located on the dispenser.

-  Press this icon turn the dispenser light on or off.

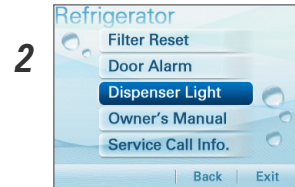

Press the ▲ or ▼ button to select **Dispenser Light**.

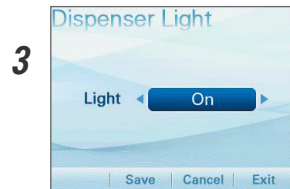

Press the ◀ or ▶ button to select **On**.

[On] <--> [Off]

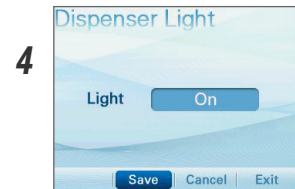

Press the ▼ button to select **Save**.

5 Return to the **Refrigerator** menu.

- **When On is selected**, the dispenser light is always on.
- **When Off is selected**, the dispenser light is turned on only when the dispenser lever is pressed.

❑ **Owner's Manual**

You can select from Key Guide, Tem. Adjustment, Child Lock, Weather Forecast, Proper Food Storage, Fridge Maintenance Guide, Freezer Maintenance Guide or Elimination of Odor function.

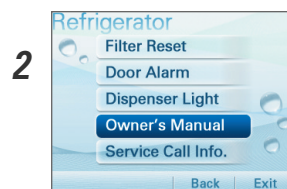

Press the ▲ or ▼ button to select **Owner's Manual**.

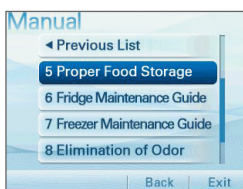
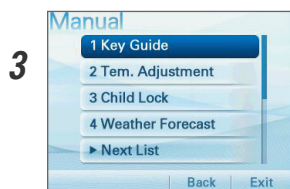

Select the menu using the ▲ or ▼ button.

4 Press the **SELECT** button.

5 Select the detail menu using the ◀ or ▶ button.

6 Press the ▼ button to select **List**.

7 Return to Refrigerator menu.

1. Key Guide

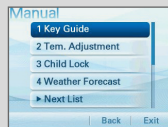

Press the ▲ or ▼ button to select **Key Guide**.

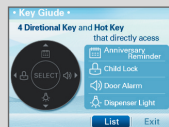

You will see the detail menu.

2. Tem. Adjustment

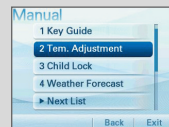

Press the ▲ or ▼ button to select **Tem. Adjustment**.



You can check the detail menu using the ◀ or ▶ button.

3. Child Lock



Press the ▲ or ▼ button to select **Child Lock**.

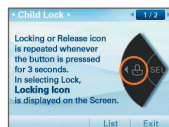

You can check the detail menu using the ◀ or ▶ button.

4. Weather Forecast

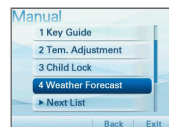

Press the ▲ or ▼ button to select **Weather Forecast**.



You can check the detail menu using the ◀ or ▶ button.

5. Proper Food Storage

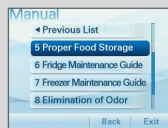

Press the ▲ or ▼ button to select **Proper Food Storage**.

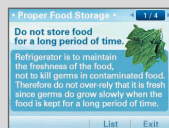

You can check the detail menu using the ◀ or ▶ button.

6. Fridge Maintenance Guide

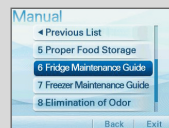

Press the ▲ or ▼ button to select **Fridge Maintenance Guide**.

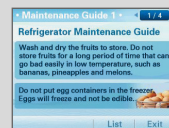

You can check the detail menu using the ◀ or ▶ button.

7. Freezer Maintenance Guide

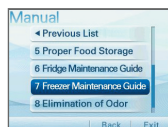

Press the ▲ or ▼ button to select **Freezer Maintenance Guide**.



You can check the detail menu using the ◀ or ▶ button.

8. Elimination of Oder



Press the ▲ or ▼ button to select **Elimination of Oder**.

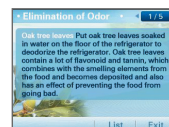

You can check the detail menu using the ◀ or ▶ button.

❑ **Service Call Info.**

This shows the number to call for service in the US or Canada.

1



2



Press the ▲ or ▼ button to select **Service Call Info.**

3



You will see the detail menu.

Settings

You can select from Display Image, Display Theme, Power Saver, Screen Backlight/Button Sound, or °C/°F Setting function.

1



2



Select the menu using the ▲ or ▼ button.

3



Select and Save the menu you want using the ◀ or ▶ button.

4 Return to the **Settings** list menu.

□ **Display Image**

You can select the standby screen setting.



1 Press the ▲ or ▼ button to select **Display Image**.

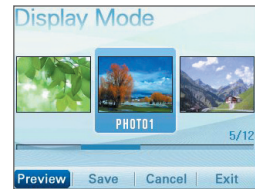

2 Select the desired photo using the ◀ or ▶ button.

Press the ▼ button to select **Preview**.



3 You can preview other standby screens using the ◀ or ▶ button.



4 Press the ▼ button to select **Save**.



5

□ **Display Theme**

You can select the screen theme setting.

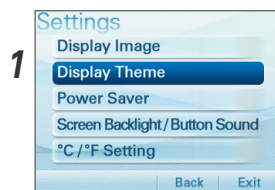

1 Press the ▲ or ▼ button to select the **Display Theme**.



2 Select the menu using the ◀ or ▶ button.

Press the ▼ button to select **Save**.

[Character] <--> [Motion]

❑ Power Saver

You can select the Power Saver function.

< When Power Saver function is selected >

- When selecting [Use of Power Saver], the LCD screen backlight turns off after eclipse of designated time.



Press the ▲ or ▼ button to select **Power Saver**.

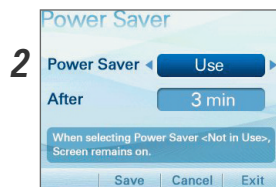

Press the ◀ or ▶ button to select **Use**.

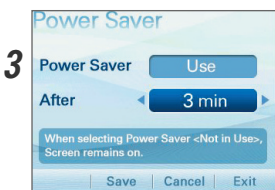

Select the desired time using the ◀ or ▶ button.

[1min] <--> [3min] <--> [5min]

4 The Power Saver turns the display off at the preset time.

< When Power Saver function is not selected >

- When selecting [Not in Use of Power Saver], the LCD screen is converted to Screen Protector after a minute.

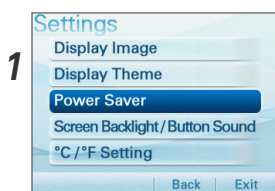

Press the ▲ or ▼ button to select **Power Saver**.

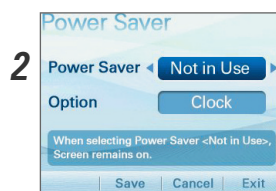

Press the ◀ or ▶ button to select **Not in Use**.

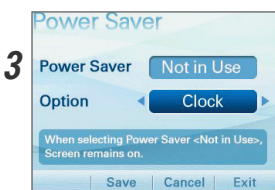

Select the menu using the ◀ or ▶ button.



[Clock]

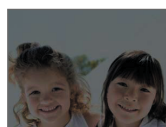

[Photo]



[Not in Use]

When selecting **Not in Use**, the current standby screen is saved as Screen Saver.

☐ **Screen Backlight/Button Sound**

- You can adjust the screen brightness.
- When selecting the button sound, you can turn the button sound on or off.

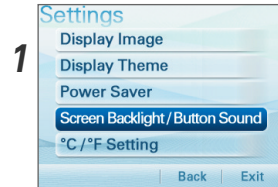

1

Press the ▲ or ▼ button to select **Screen Backlight/Button Sound**.

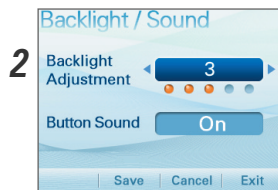

2

Select the brightness value using the ◀ or ▶ button.

Press the ▼ button to select **Save**.

[1 <--> 2 <--> 3 <--> 4 <--> 5]

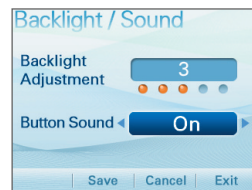

Select and Save the menu you want using the ◀ or ▶ button.

[On] <--> [Off]

☐ **°C/°F Setting**

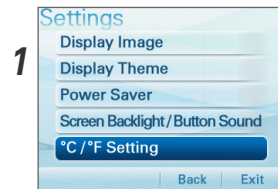

1

Press the ▲ or ▼ button to select **°C/°F Setting**.



2

Select the menu you want using the ◀ or ▶ button.

[Centigrade] <--> [Fahrenheit]

Press the ▼ button to select **Save**.

Photo Album

You can register a photo or setup the standby screen.

< When setting to the standby screen >



Select the desired photo using the ◀ or ▶ button.

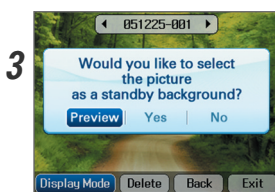

Press the ▼ button to select **Display Image**.
Press the ◀ or ▶ button to select **Preview**.



Press the ◀ or ▶ button to select **Save**.

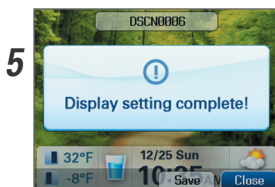

6 Return to the standby screen.

< When deleting >

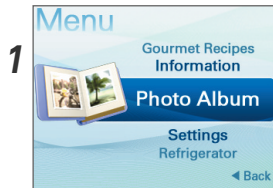

Select the desired photo using the ◀ or ▶ button.

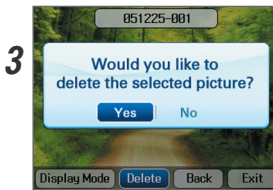

Press the ▼ button to select **Delete**.

Press the ◀ or ▶ button to select **Yes**.

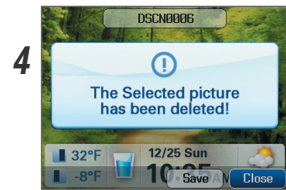

Press the ◀ or ▶ button to select **Save**.

5 Return to the standby screen.

< When deleting all >

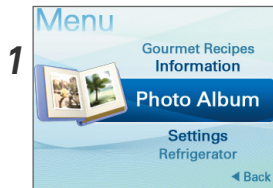

Press the ▼ button to select **Delete All**.

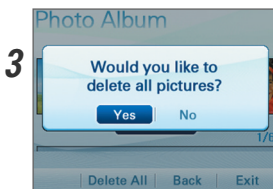

Press the ◀ or ▶ button to select **Yes**.

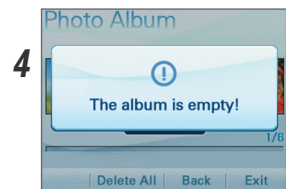

Return to the standby screen.

< When registering the photo >



When you connect the USB to the USB port, it reads the photo data and adds the album list.

< When using USB >



When selecting **Photo Album** and then connecting the USB port, **Import** item is activated.



When selecting **Import**, it reads data from the USB port. The Pop-up screen appears to inform progress process during reading.



After setting up desired photo from data read, select **Import**.



After **Import Check** popup screen appears, you can check photo from the photo album list.

- Position of USB port for refrigerator.
- If desiring to use the USB port, firstly select the photo album item and then insert the USB port.
- It takes several seconds if reading photo from the USB port.
- Your USB port may not be compatible from time to time.
- Use the product where photo is saved in the USB. If any photo are not saved, firstly save photo in the USB port.



Lock

Lock can be used to disable the buttons and prevent tampering with the settings.

-  Select Lock using the buttons.
- Lock or unlock buttons and dispenser by pressing down the button for 3seconds.
- When lock is selected, the dispenser and buttons will be locked and will not operate.
- When lock is selected, the lock icon will appear on the screen.

< To set the Lock >

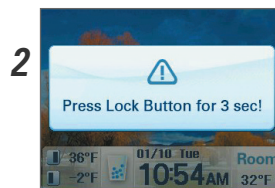
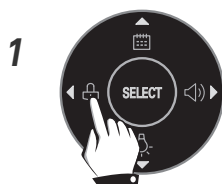

When you see this message, press the **Lock** button for 3 seconds.

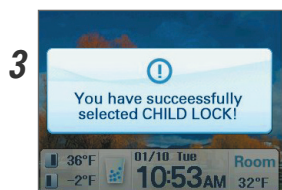

You will see this message.

4 Return to the standby screen.

< To cancel the Lock >

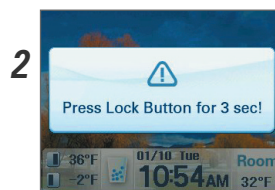
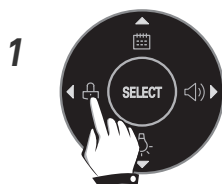

When you see this message, press the **Lock** button for 3 seconds.

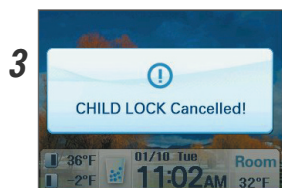

You will see this message.

4 Return to the standby screen.

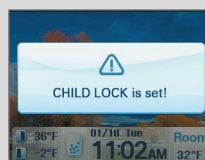

Pressing the Refrigerator button when the Lock is set will display this message.

Other functions***Ambient Temperature Display Window.***

- Temperature is displayed only between 16°F ~ 120°F (-9°C ~ 49°C).
- Temperature less than 15°F (-9°C) is indicated with LO and temperature more than 121°F (49°C) is indicated with HI.

***Diagnostic (failure detection) function***

- The diagnostic function automatically detects failure when failure is found in product during the use of refrigerator.
- If your refrigerator fails, do not turn off the power. Call 1-800-243-0000 24/7 and select the option to locate an authorized servicer or call our support line for assistance. Turning off the appliance will make it more difficult for the service technician to determine the problem.

How ice/cold water is supplied

Water is cooled while stored in the water tank in freezer door, and then sent to the dispenser.

Ice is made in the automatic icemaker and sent to the dispenser.

Cautions**Throw away the ice (about 20 pieces) and water (about 7 glasses) first made after refrigerator installation.**

This is also necessary when the refrigerator has not been used for a long time.

Keep children away from the dispenser.

Children may play with or damage the controls.

Be careful that food does not block the ice passage.

If foods are placed at the entrance of ice passage, the dispenser may malfunction. The passage may also become blocked with frost if only crushed ice is used. Remove the frost that accumulates.

Storing cans or other items in the ice bin may damage the icemaker or the container may burst.**Never use thin crystal glass or crockery to collect ice.**

Such glasses or containers may be broken, and glass fragments could be in the ice.

Put ice first into a glass before filling water or other beverages.

Water may be splashed if ice is added to existing liquid in a glass.

Keep your hands out of the ice door and passage.

You might break something or injure yourself.

Never remove the ice maker cover.**Shake the ice bin occasionally to level the ice in it.**

Sometimes the ice piles up near the icemaker, causing the icemaker to misinterpret the bin level and stop producing ice.

If you find ice or water dispensed unexpectedly, contact an Authorized Service Center. (Call 1-800-243-0000 24/7 and select the option to locate an authorized servicer.)**Never use too narrow or deep glass.**

Ice may be jammed in the ice passage and, thus, the refrigerator may fail.

Keep the glass at a proper distance from ice outlet.

A glass too close to the outlet may prevent ice from coming out.

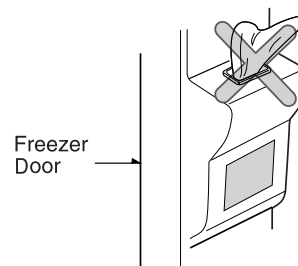

Shelf height adjustment

Shelf

The refrigerator compartment shelves are adjustable so you can locate them according to your needs.

- **Slide Shelf**
Pull the shelf ahead and take off it while lifting both front and rear part.



- **Fixed Shelf, Folding Shelf**
Lightly lift up the front part of shelf to pull it ahead and then take off it while lifting the rear part of shelf.

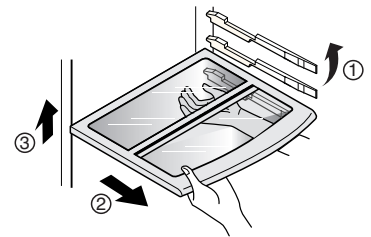

NOTE

- Make sure the shelf is horizontal. If not, it may drop.

Slide-Under Shelf

You can store taller items such as a gallon container or bottles by simply pushing in front half of shelf underneath back half of shelf. Pull toward you to return to a full shelf.

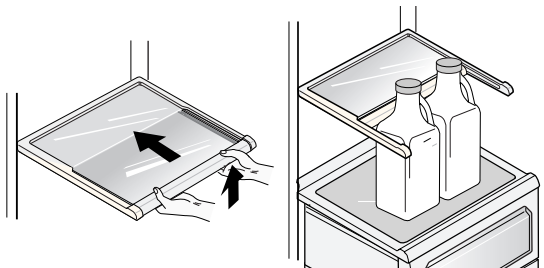

Humidity control in the vegetable compartment

The humidity can be controlled by adjusting the humidity control switch to the left or right when storing vegetables or fruits.

High humidity

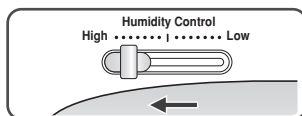

Low humidity

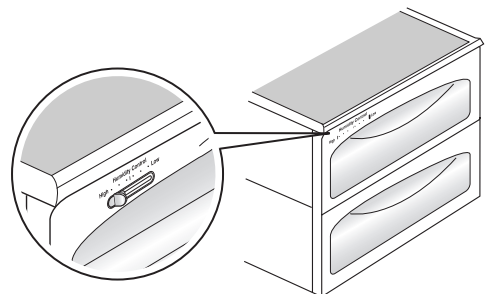
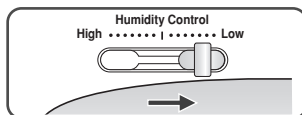

OptiFresh temperature bin



Method to use

You can select the optimum temperature to store some types of foods.

- Vegetables, fruits, cold storage items requiring humidity maintenance can be stored under optimal condition by pressing the button.

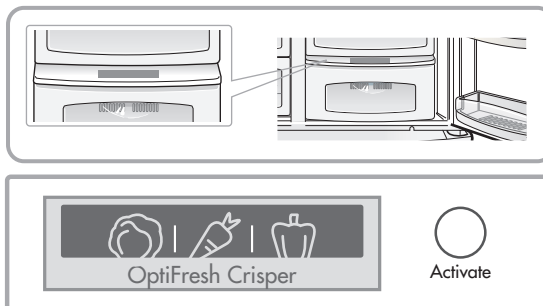

- If you open the refrigerator door, an indicator lamp shows the status of the OptiFresh. The lamp goes off when the door is closed.
- Press the button to cycle between **ON** and **OFF**.

OptiFresh

When removing OptiFresh

- First, remove the vegetable bin.
- After holding both ends of the OptiFresh ① and ② pull it outward.

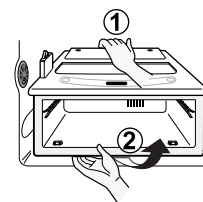

When installing OptiFresh

- Fit the OptiFresh case on to the ledge ① and gently slide it in ② .
- If forced, the connecting parts can be damaged.

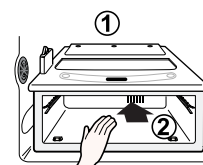

Location of foods

(Refer to Identification of Parts, page 4.)

Snack drawer

Store small foods such as bread, snacks, etc.

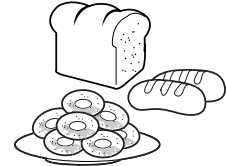

Freezer compartment shelf

Store various frozen foods such as meat, fish, ice cream, frozen snacks, etc.

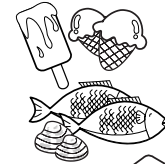

Freezer compartment door rack

Store small packed frozen food. Items stored in the door racks don't stay quite as cold as in the rest of the freezer. Store ice cream and similar items on a shelf in the freezer instead.



Freezer compartment drawer

Store meat, fish, chicken, etc. after wrapping them with thin foil. Store dry.

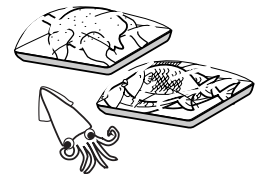

Milk product corner

Store milk products such as butter, cheese, etc.

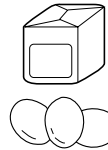

Refreshment center

Store foods of frequent use such as beverages, etc.



Refrigerator compartment shelf

Do not pack the freezer or refrigerator tightly. Allow a little room for proper air circulation to aid cooling.

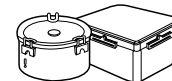

Refrigerator compartment door rack

Store small packed food or beverages such as milk, juice, etc.



Vegetable drawer

Store vegetables or fruits.

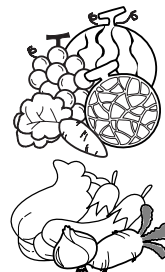

Storing foods

- Store fresh food in the refrigerator compartment. How food is frozen and thawed is an important factor in maintaining its freshness and flavor.
- Do not store food which spoils easily at low temperatures, such as bananas and melons.
- Allow hot food to cool prior to storing, placing hot food in the refrigerator could spoil other food, and lead to higher energy consumption.
- When storing the food, cover it with vinyl wrap or store in a container with a lid. This prevents moisture from evaporating, and helps food to keep its flavor and nutrition.
- Do not block air vents with food. Smooth circulation of chilled air keeps refrigerator temperatures even.
- Do not open the door frequently. Opening the door lets warm air enter the refrigerator, and cause temperatures to rise.
- Never overload the door racks because they may push against by inner racks so that the door cannot be fully closed.

Freezer compartment

- Do not store bottles in the freezer compartment, they may break when frozen.
- Do not refreeze food that has been thawed. This causes loss of flavor and nutrition.
- When storing frozen food like ice cream for a long period, place it on the freezer shelf, not in the door rack.
- Do not touch the cold foods or containers, especially made of metal, with wet hands and place glass products in the freezer compartment.
 - Damp skin can freeze and stick to cold surfaces, causing frostbite and other serious injuries.

Refrigerator compartment

- Avoid placing moist food in top refrigerator shelves, it could freeze from direct contact with chilled air.
- Always clean food prior to refrigeration. Vegetables and fruits should be washed and wiped, and packed food should be wiped, to prevent adjacent food from spoiling.
- When storing eggs in their storage rack or box, ensure that they are fresh, and always store them in an upright position to keep them fresh longer.

NOTE

- If you keep the refrigerator in a hot and humid place, frequent opening of the door or storing a lot of vegetables in it may cause condensation to form. Wipe the condensation with a clean cloth or a paper towel.

How to remove and replace parts

NOTE

- Dismantling is done in the reverse sequence of assembly.
Be sure to unplug the power plug before dismantling and assembly.
Never apply severe force to dismantle parts. Parts may be damaged.

Freezer compartment lamp

To remove the lamp cover, separate the shelf over the lamp cover and pull the lamp cover forwards ② while pressing the bottom side of the lamp cover upwards ①. Turn the bulb counterclockwise.
Use a 40-watt bulb (max.) which can be purchased at a service center.

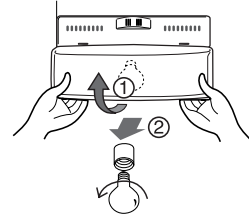

Freezer compartment shelf

To remove a shelf, push the shelf to the left ①, lift the left part of the shelf a bit ②, lift the right part up ③, and take it out.

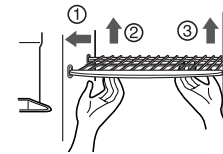

Door rack and support

Lift the door rack holding both sides ① and pull it out ②.

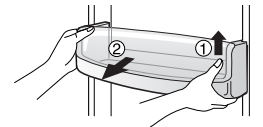

Ice storage bin

Hold the ice storage bin as shown in the right figure and pull it out ② while slightly lifting it ①.

- Do not dismantle the ice storage bin unless it is necessary.
- Use both hands to remove the ice bin to avoid dropping it.

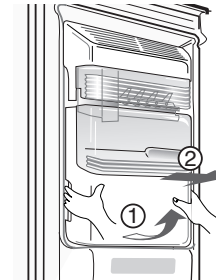

After dispenser is used

The water collector has no self-draining function. It should be cleaned regularly. Remove the cover by pulling the front side of water collector cover and dry it with a cloth.

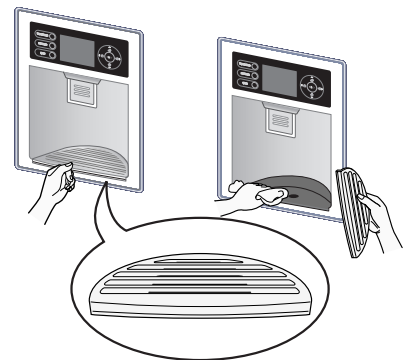

Upper lamp in refrigerator compartment

To remove the lamp cover, pull the lamp cover forward while pressing the bottom side of the lamp cover upward. Turn the bulb counterclockwise.

Use a 40-watt bulb (max.) which can be purchased at a service center.

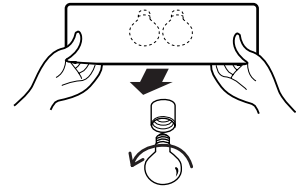

Lower lamp in refrigerator compartment

Separate the lamp cover by holding both lower sides of it and pulling it forward. Turn the bulb counterclockwise.

Use a 40-watt bulb (max.) which can be purchased at a service center.

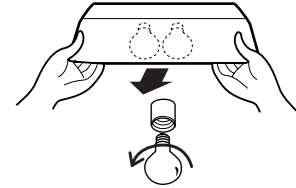

NOTE

- Be sure to remove the necessary door racks and other parts to allow clearance to remove the vegetable compartment, snack, drawer, and home bar cover.

Vegetable compartment cover

- To remove the vegetable compartment cover, pull out the vegetable compartment a bit to the front ①, lift the front part of the vegetable compartment cover as shown by ②, and take it out.

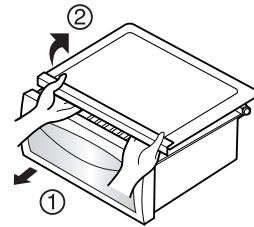

Filter replacement

We recommend replacing the filter when the water filter indicator light turns on or your water dispenser or ice maker decreases noticeably. After changing the water filter cartridge, reset the water filter status display and indicator light by pressing and holding the **BUTTON** for 3 seconds.

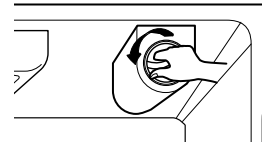

- 1) Remove the old cartridge.
Rotate the knob of the cartridge counter clockwise. When the cartridge is removed, you will feel it click out of place.
Pull out the cartridge.

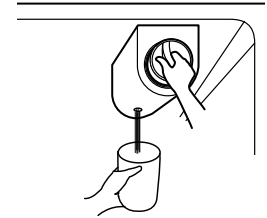

NOTE

- Replacing filter causes small amount of water (around 1 oz or 25 cc) to flow out. Please put up a cup under the hole to prevent it.

- 2) Replace with a new cartridge.
Take the new cartridge out of its packaging and remove protective cover from the o-rings. With cartridge knob in the vertical position, push the new filter cartridge into the cover until it stops.
If you can't turn the filter from side to side, it isn't fully inserted. Push it in firmly and twist it into place. You will hear the snap when it clicks into place. Using its handle, twist the cartridge clockwise about 1/4 turn. You will hear the snap when it clicks into place.

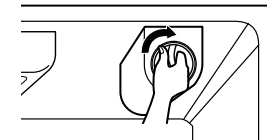
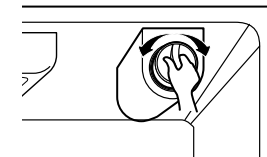

- 3) Flushing the Water System After Replacing Filter.
Dispense water through the water dispenser for 3 minutes to purge the system.

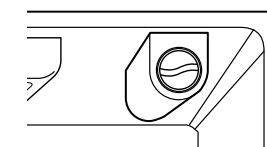

General information

Vacation time	<p>During average length vacations, you will probably find it best to leave the refrigerator in operation. Place freezable items in freezer for longer life.</p> <p>When you plan to store the refrigerator, remove all food, disconnect the power cord, clean the interior thoroughly, and block the doors open to prevent mold and mildew. Be certain the stored refrigerator does not present a child entrapment danger.</p>
Power failure	<p>Most power failures that are corrected in an hour or two will not affect your refrigerator temperatures. However, you should minimize the number of door openings while the power is off.</p>
If you move	<p>Unload the refrigerator to relocate it. (This is probably not necessary to pull it out for cleaning behind it.) Be sure to let the refrigerator warm up to room temperature, and dry the inside before closing the doors to pack it for moving.</p> <p>To avoid damaging the height adjusting screws, turn them all the way into the base.</p>
Anti-condensation pipe	<p>The outside wall of the refrigerator cabinet may sometimes get warm, especially just after installation. Don't be alarmed. This is due to the anti-condensation pipe, which pumps hot refrigerant to prevent sweating on the outer cabinet wall.</p>

Cleaning

It is important that your refrigerator be kept clean to prevent undesirable odors. Spilled food should be wiped up immediately, since it may acidify and stain plastic surfaces if allowed to settle.

Exterior	<p>Use a lukewarm solution of mild soap or detergent to clean the durable finish of your refrigerator. Wipe with a clean damp cloth and then dry.</p>
Interior	<p>Regular cleaning is recommended. Wash all compartments with a baking soda solution or a mild detergent and warm water. Rinse and dry. Be sure to allow the soda to dissolve completely so it will not act as an abrasive compound.</p>
After cleaning	<p>Please verify that the power cord is not damaged, power plug is not overheated, or power plug is well inserted into the power consent.</p>
Warning	<p>Always remove the power cord from the wall outlet prior to cleaning in the vicinity of electrical parts (lamps, switches, controls, etc.).</p> <p>Wipe up excess moisture with a sponge or cloth to prevent water or liquid from getting into any electrical part and causing an electric shock.</p> <p>Never use metallic scouring pads, brushes, coarse abrasive cleaners, strong alkaline solutions, or flammable or toxic cleaning liquids on any surface.</p> <p>Do not touch frozen surfaces with wet or damp hands, because damp objects will stick to extremely cold surfaces.</p>

Troubleshooting

Before calling for service, review this list. It may save you both time and expense. This list includes common occurrences that are not the result of defective workmanship or materials in this appliance.

Occurrence	Possible Cause	Solution
Normal Operations Refrigerator		
Refrigerator compressor does not run.	Refrigerator control is off.	Set refrigerator control.
	Refrigerator is in defrost cycle.	This is normal for a fully automatic defrosting refrigerator. The defrost cycle occurs periodically.
	Plug at wall outlet is disconnected.	Make sure plug is tightly pushed into outlet.
	Power outage. Check house lights.	Call local electric company.
Refrigerator runs too much or too long	Refrigerator is larger than the previous one you owned.	This is normal. Larger, more efficient units run longer.
	Room or outside weather is hot.	It is normal for the refrigerator to work longer under these conditions.
	Refrigerator has recently been disconnected for a period of time.	It takes a few hours for the refrigerator to come down to room temperature completely.
	Automatic icemaker is operating.	Operation of the ice maker causes the refrigerator to run slightly longer.
	Large amounts of warm or hot food may have been stored recently.	Warm food will cause the refrigerator to run longer until the desired temperature is reached.
	Doors are opened too frequently or too long.	Warm air entering the refrigerator causes it to run more. Open the door less often.
	Refrigerator or freezer door may be slightly open.	Make sure the refrigerator is level. Keep food and containers from blocking the door. See problem section OPENING/CLOSING of doors, page 11.
	Refrigerator control is set too cold.	Adjust the refrigerator control to a warmer setting until the refrigerator temperature is satisfactory.
	Refrigerator or freezer gasket is dirty, worn, cracked, or poorly fitted.	Clean or change gasket. Leaks in the door seal will cause the refrigerator to run longer in order to maintain desired temperatures.

Occurrence	Possible Cause	Solution
Refrigerator compressor does not run.	Thermostat is keeping the refrigerator at a constant temperature.	This is normal. The Refrigerator goes on and off to keep the temperature constant.
Temperatures are too cold		
Temperature in the freezer is too cold but the Refrigerator Temperature is Satisfactory.	Freezer control is set too cold	Adjust the freezer control to a warmer setting until the freezer temperature is satisfactory.
Temperature in the refrigerator is too cold and the freezer temperature is satisfactory.	Refrigerator control is set too cold.	Adjust the refrigerator control to a warmer setting
Food stored in drawers freezes.	Refrigerator control is set too cold.	Adjust the refrigerator to a warmer setting.
Meat stored in fresh meat drawer freezes.	Meat should be stored at a temperature just below the freezing point of water (32°F, 0°C) for maximum fresh storage time.	It is normal for ice crystals to form due to the moisture content of meat.
Temperatures are too warm		
Temperatures in the refrigerator or freezer are too warm.	Freezer control is set too warm.	Adjust the freezer or refrigerator control to a colder setting until the freezer or refrigerator temperature is satisfactory.
	Refrigerator control is set too warm. Refrigerator control has some effect on freezer temperature.	Adjust the freezer or refrigerator control to a colder setting until the freezer or refrigerator temperature is satisfactory.
	Doors are opened too frequently or too long.	Warm air enters the refrigerator/ freezer whenever the door is opened. Open the door less often.
	Door is slightly open.	Close the door completely.
	Large amounts of warm or hot food may have been stored recently.	Wait until the refrigerator or freezer has had a chance to reach its selected temperature.
	Refrigerator has recently been disconnected for a period of time.	A refrigerator requires several hours to cool down completely.
Temperature in the refrigerator is too warm but the freezer temperature is satisfactory.	Refrigerator control is set too warm.	Adjust the refrigerator control to a colder setting.

Occurrence	Possible Cause	Solution
Sound and Noise		
Louder sound levels when Refrigerator is on.	Today's refrigerators have increased storage capacity and maintain more even temperatures.	It is normal for sound levels to be higher.
Louder sound levels when compressor comes on.	Refrigerator operates at higher pressures during the start of the ON cycle.	This is normal. The sound will level off as the refrigerator continues to run.
Vibrating or rattling noise.	Floor is uneven or weak. Refrigerator rocks on the floor when it is moved slightly.	Be sure floor is level and solid and can adequately support refrigerator.
	Items placed on the top of the refrigerator are vibrating.	Remove items.
	Dishes are vibrating on the shelves in the refrigerator.	It is normal for dishes to vibrate slightly. Move dishes slightly. Make sure refrigerator is level and firmly set on floor.
	Refrigerator is touching wall or cabinets.	Move refrigerator so that it does not touch the wall or refrigerator.
Water/Moisture /Ice Inside Refrigerator		
Moisture collects on the inside walls of the refrigerator.	The weather is hot and humid which increases the rate of frost buildup and internal sweating.	This is normal.
	Door is slightly open.	See problem section Opening/Closing of doors, page 11.
	Door is opened too often or too long.	Open the door less often.
Water/Moisture/Ice Outside Refrigerator		
Moisture forms on the outside of the refrigerator or between doors.	Weather is humid.	This is normal in humid weather. When humidity is lower, the moisture should disappear.
	Door is slightly open, causing cold air from the inside the refrigerator to meet warm air from the outside.	Close the door completely.
Moisture forms on the dispenser or refreshment center	Moisture may be formed in high temperature and high humidity since heater turns off if not opening the doors for a long time.	Wipe the moisture and open the doors again.

Occurrence	Possible Cause	Solution
Odors in Refrigerator		
	Interior needs to be cleaned.	Clean interior with sponge, warm water, and baking soda. Be sure the soda is completely dissolved so it will not act as an abrasive compound.
	Food with strong odor is in the refrigerator.	Cover food completely.
	Some containers and wrapping materials produce odors.	Use a different container or brand of wrapping materials.
Opening/Closing of Doors/Drawers		
Door(s) will not close.	Food package is keeping door open.	Move packages that keep door from closing.
Door(s) will not close.	Door was closed too hard, causing other door to open slightly.	Close both doors gently.
	Refrigerator is not level. It rocks on the floor when it is moved slightly.	Adjust the height adjusting screw.
	Floor is uneven or weak. Refrigerator rocks on the floor when it is moved slightly.	Be sure floor is level and can adequately support refrigerator. Contact carpenter to correct sagging or sloping floor.
	Refrigerator is touching wall or cabinets.	Move refrigerator.
Drawers are difficult to move.	Food is touching shelf on top of the drawer	Keep less food in drawer.
	Track that drawer slides on is dirty.	Clean drawer and track.
Dispenser		
Dispenser will not dispense ice	Ice storage bin is empty.	When the first supply of ice is dropped into the bin, the dispenser should operate.
	Freezer temperature is set too warm.	Turn the freezer control to a higher setting so that ice cubes will be made. When the first supply of ice is made, the dispenser should operate.
	Household water line valve is not open.	Open household water line valve and allow sufficient time for ice to be made. When ice is made, dispenser should operate.
	Refrigerator or freezer door is not closed.	Be sure both doors are closed.

Occurrence	Possible Cause	Solution
Dispenser will not dispense ice.	Ice has melted and frozen around auger due to infrequent use, temperature fluctuations, and/or power outages.	Remove ice storage bin, and thaw and the contents. Clean bin, wipe dry, and replace in proper position. When new ice is made, dispenser should operate.
Ice dispenser is jammed.	Ice cubes are jammed between the ice maker arm and back of the bin.	Remove the ice cubes that are jamming the dispenser.
	Ice cubes are frozen together.	Use the dispenser often so that cubes do not freeze together.
	Ice cubes that have been purchased or made in some other way have been used in the dispenser.	Only the ice cubes made by the ice maker should be used with the dispenser.
Dispenser will not dispense water.	Household water line valve is not open.	Open household water line valve.
	Refrigerator or freezer door is not closed.	Be sure both doors are closed.
Water has an odd taste and/or odor.	Water has been in the tank for too long.	Draw and discard 7 glasses of water to freshen the supply. Draw and discard an additional 7 glasses to completely rinse out tank.
	Unit not properly connected to cold water line.	Connect unit to cold water line which supplies water to kitchen faucet.
Sound of ice dropping	This sound is normally made when automatically made ice is dropped into ice storage bin. Volume may vary according to refrigerator's location.	
Sound of water supply	This sound is normally made when ice maker is supplied with water after dropping the automatically made ice.	
Other	Please thoroughly read Automatic Icemaker and Dispenser in this manual on pages 15.	
Weather Forecast		
Function is not operate	Reception of weather forecast information received and displayed on the screen is subject to vary depending on your region and location of refrigerator. Check your zip code in this manual pages 151 or www.ambientdevices.com/cat/device/coverage.html	

CUSTOMER ASSISTANCE NUMBERS:
<http://www.lgservice.com>

- To Prove Warranty Coverage
Retain your sales receipt to prove date of purchase.
A copy of your sales receipt must be submitted at the time warranty service is provided.
- To Obtain Product, Customer, or Service Assistance
Call Toll-free for Customer Service
Tel : 1-800-243-0000
- To Obtain Nearest Authorized Service Center
Call 1-800-243-0000, push option #1, 24 hours a day, 7 days per week.
Please have your product type (Refrigerator), model number, serial number, and postcode ready.

LG ELECTRONICS, INC.
LG REFRIGERATOR LIMITED WARRANTY - USA



Your LG Refrigerator will be repaired or replaced, at LG's option, if it proves to be defective in material or workmanship under normal use, during the warranty period (Warranty Period) set forth below, effective from the date ("Date of Purchase") of original consumer purchase of the product. This warranty is good only to the original purchaser of the product and effective only when used in the United States, including Alaska, Hawaii, and U.S. Territories.

<p><u>WARRANTY PERIOD:</u></p> <p>REFRIGERATOR/FREEZER</p> <p>LABOR: One Year from the Date of Purchase.</p> <p>PARTS: One Year from the Date of Purchase.</p> <p>SEALED SYSTEM (Compressor, Condenser, and Evaporator)</p> <p>LABOR: One Year from the Date of Purchase.</p> <p>PARTS: Seven years from the Date of Purchase.</p> <p>Replacement Units and Repair Parts are warranted for the remaining portion of the original unit's warranty period.</p>	<p><u>HOW SERVICE IS HANDLED:</u></p> <p>In-Home Service (Except Model GR051):</p> <p>Please retain dealer's dated bill of sale or delivery ticket as evidence of the Date of Purchase for proof of warranty, and submit a copy of the bill of sale to the service person at the time warranty service is provided.</p> <p>Please call 1-800-243-0000 and choose the appropriate option to locate your nearest LG Authorized Service Center. (Phones are answered 24 hours a day, 365 days per year.)</p> <p>Or visit our website at: http://www.lgservice.com</p>
---	--

THIS WARRANTY IS IN LIEU OF ANY OTHER WARRANTY, EXPRESS OR IMPLIED, INCLUDING WITHOUT LIMITATION, ANY WARRANTY OF MERCHANTABILITY OR FITNESS FOR A PARTICULAR PURPOSE. TO THE EXTENT ANY IMPLIED WARRANTY IS REQUIRED BY LAW, IT IS LIMITED IN DURATION TO THE EXPRESS WARRANTY PERIOD ABOVE. NEITHER THE MANUFACTURER NOR ITS U.S. DISTRIBUTOR SHALL BE LIABLE FOR ANY INCIDENTAL, CONSEQUENTIAL, INDIRECT, SPECIAL, OR PUNITIVE DAMAGES OF ANY NATURE, INCLUDING WITHOUT LIMITATION, LOST REVENUES OR PROFITS, OR ANY OTHER DAMAGE WHETHER BASED IN CONTRACT, TORT, OR OTHERWISE. Some states do not allow the exclusion or limitation of incidental or consequential damages or limitations on how long an implied warranty lasts, so the above exclusion or limitation may not apply to you. This warranty gives you specific legal rights and you may also have other rights that vary from state to state.

Reception of weather forecast information received and displayed on the screen is subject to vary depending on your region and location of refrigerator. Thereby LG does not guarantee and will not be held responsible for accuracy of the weather information. Weather forecast information is only available in U.S.A

THIS LIMITED WARRANTY DOES NOT APPLY TO:

- Service trips to your home to deliver, pick up, and/or install the product, instruct, or replace house fuses or correct wiring, or correction of unauthorized repairs.
- Damages or operating problems that result from misuse, abuse, operation outside environmental specifications or contrary to the requirements of precautions in the Operating Guide, accident, vermin, fire, flood, improper installation, acts of God, unauthorized modification or alteration, incorrect electrical current or voltage, or commercial use, or use for other than intended purpose.
- Repairs when your LG refrigerator is used in other than normal, single-family household use.

The cost of repair or replacement under these excluded circumstances shall be borne by the consumer.

CUSTOMER INTERACTIVE CENTER NUMBERS

<p>To obtain Customer Assistance, Product Information, or Dealer or Authorized Service Center location:</p>	<p>Call 1-800-243-0000 (24 hours a day, 365 days per year) and select the appropriate option from the menu.</p> <p>Or visit our website at: http://www.lgservice.com</p>
--	---

TO CONTACT LG ELECTRONICS BY MAIL:

LG Customer Interactive Center
P. O. Box 240007
201 James Record Road
Huntsville, Alabama 35824
ATTN: CIC

Table des matières

Introduction	Enregistrement	53
	Instructions de sécurité importantes	53
	Identification des composants	54
Installation	Où l'installer	55
	Extraction de la porte	56
	Montez les portes à compartiment du congélateur et du réfrigérateur	57
	Installation d'approvisionnement en eau	57
	Instructif pour la connexion d'eau	58
	Ajustement de la taille	61
	Connexions d'équipement externe	62
Fonctionnement	Démarrage	63
	Réglage des températures et des fonctions	63
	Température	64
	Distributeur	65
	Menu	66
	Etagère	87
	Contrôle de l'humidité dans le bac à légumes	87
	Casier à température OptiFresh	88
	OptiFresh	88
	Conseils pour le stockage des aliments	Rangement des aliments
Stockage des aliments		90
Entretien et maintenance	Comment démonter les composants	91
	Information générale	94
	Nettoyage	94
	Dépannage	95
	Garantie	100
	Code postal	151

Enregistrement

Le modèle et les numéros de série se trouvent à l'intérieur ou dans la partie arrière du compartiment du réfrigérateur de cette unité. Ces numéros correspondent uniquement à cette unité et ne sont disponibles pour aucune autre. Vous devriez enregistrer l'information demandée ici et conserver ce guide comme un document permanent de votre achat. Agrafez votre reçu ici.

Date d'achat : _____
 Consignataire : _____
 Adresse du consignataire : _____
 N° de téléphone du consignataire : _____
 N° de modèle : _____
 N° de série : _____

Instructions de sécurité importantes

Avant d'utiliser ce réfrigérateur pour la première fois, assurez-vous qu'il est bien installé et rangé suivant les instructions d'installation fournies par dans ce document.

Ne débranchez jamais votre réfrigérateur en tirant du câble d'alimentation. Veuillez saisir fermement la fiche et bien la débrancher de la prise de courant.

Lorsque vous éloignez l'appareil du mur, assurez-vous de ne pas le faire rouler sur le cordon d'alimentation ou de ne pas abîmer celui-ci d'une autre manière. Ne cassez ni endommagez la conduite d'eau.

Dès que votre réfrigérateur sera en marche, ne touchez pas aux surfaces froides du compartiment du congélateur, surtout si vos mains sont humides ou mouillées. Votre peau pourrait s'adhérer à ces surfaces extrêmement froides.

Débranchez le cordon d'alimentation de la prise de courant pour le nettoyage ou pour d'autres opérations. Ne le touchez jamais avec les mains humides car vous risquez de subir un choc électrique ou de vous blesser.

N'endommagez, pliez, enrroulez, tirez ni tordez jamais le cordon d'alimentation car un câble abîmé peut provoquer un incendie ou un choc électrique. Si vous doutez que l'appareil soit correctement branché sur une prise avec mise à la terre, contactez un électricien qualifié.

Ne rangez jamais des produits en verre dans le congélateur car ils peuvent se casser à cause de la dilatation de leur contenu lors de la congélation.

Ne placez jamais vos mains dans le bac à stockage de glaçons de la glacière automatique. Vous risquez de vous blesser lors du fonctionnement de la glacière.

L'appareil n'a pas été conçu pour être utilisé par de petits enfants sans supervision.

Les petits enfants devraient être supervisés afin d'assurer qu'ils ne jouent pas avec l'appareil.

Ne permettez jamais quelqu'un grimper, s'assoit, se mette debout ou se pendre à la porte centrale du réfrigérateur. Ces actions pourraient abîmer le réfrigérateur et provoquer que celui-ci tombe, produisant des blessures personnelles graves.

Avant de ranger votre réfrigérateur à sa place définitive, il est important de vous assurer que la connexion électrique est correcte.

Il faut une connexion électrique avec mise à la terre de 115 Volts, 60 Hz., AC avec fusible de 15 ou 20 ampères seulement. Nous vous recommandons d'avoir un circuit séparé, destiné uniquement à votre réfrigérateur. Utilisez une prise de courant qui ne puisse pas être éteinte par un interrupteur. N'employez jamais de rallonges.

Le réfrigérateur-congélateur doit être placé de manière à permettre l'accès facile à la prise de courant pour la débrancher rapidement en cas d'urgence.

Si le cordon d'alimentation est abîmé, il doit être remplacé par le fabricant, par son service après-vente ou par une personne également qualifiée afin d'éviter tout danger.

Ne modifiez ni ne rallongez le cordon d'alimentation.

- Autrement, vous risquez de provoquer un choc électrique ou un incendie.

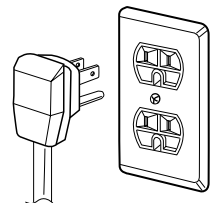

**Méthode
conseillée pour
mise à la terre**

**Accès facile à la
prise de courant
Remplacement
du cordon
d'alimentation**

⚠ Attention

**Attention:
risque pour les
enfants d'y rester
enfermés**

DANGER: Les enfants risquent d'y rester enfermés.

Before you throw away your old refrigerator or freezer:

Avant de vous débarrasser de votre vieux réfrigérateur ou congélateur:

Enlevez les portes mais laissez les étagères à sa place pour que les enfants ne puissent pas y entrer aisément.

L'appareil n'a pas été conçu pour être utilisé par de petits enfants sans supervision. Les petits enfants devraient être supervisés afin d'assurer qu'ils ne jouent pas avec l'appareil.

Ne pas stocker

Ne stockez ni utilisez d'essence ou d'autres liquides ou gaz inflammables près de cet appareil ou de n'importe quel autre appareil.

Mise à la terre

En cas de court-circuit, la mise à la terre réduit le risque de choc électrique en fournissant un câble de fuite pour le courant électrique.

Cet appareil doit être branché sur une prise reliée à la terre afin de prévenir d'éventuels chocs électriques. L'utilisation incorrecte de la prise de terre peut provoquer un choc électrique. Consultez un électricien qualifié ou une personne du service technique si vous doutez que l'appareil soit correctement branché sur une prise reliée à la terre.

**Identification des
composants**

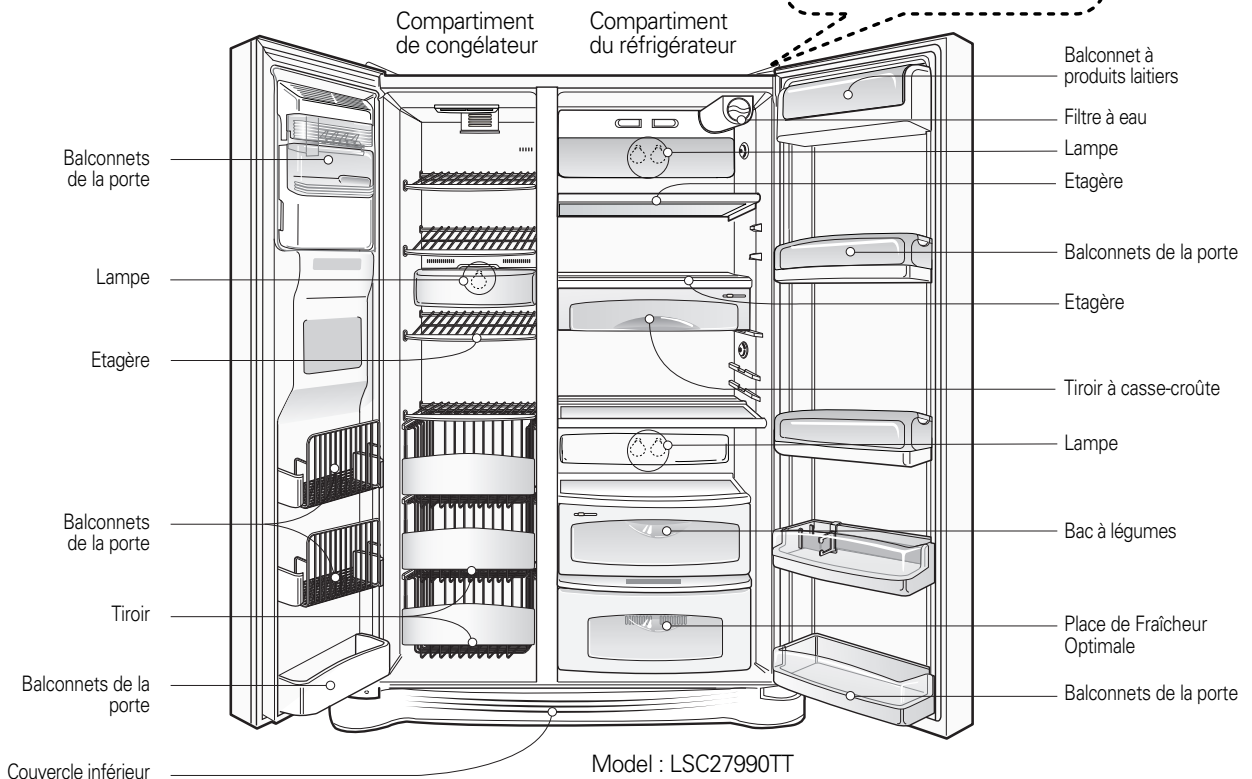
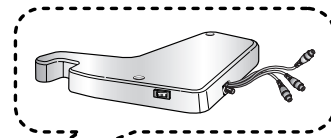

NOTE

- Les pièces, les dispositifs, et les options changent suivant le modèle. Votre modèle peut ne pas inclure toutes les options.

Où l'installer

Plancher solide et plat

Une installation instable peut causer des vibrations et du bruit. Si le plancher pour installer le réfrigérateur n'est pas parfaitement plat, faites le niveau du réfrigérateur en tournant la vis de réglage de hauteur. Le revêtement de tapis ou de sol sur lequel un réfrigérateur est installé peut être décoloré par la chaleur du fond du réfrigérateur. Ainsi, il est nécessaire de placer une garniture épaisse au-dessous du réfrigérateur.

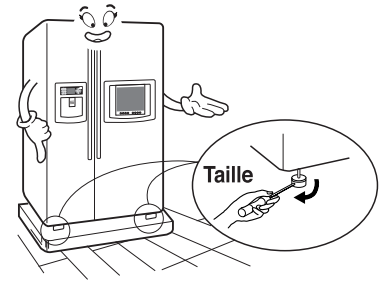

Une distance appropriée des articles adjacents

Veillez garder le réfrigérateur à une distance appropriée d'autres objets. Une distance trop petite des articles adjacents peut avoir comme conséquence des possibilités de mauvais refroidissement et une charge accrue de la consommation d'électricité

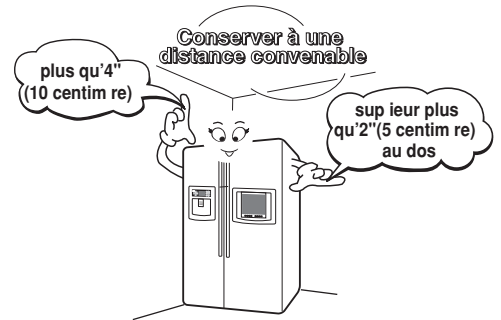

Là où l'approvisionnement en eau peut être facilement relié dans un endroit sec

Choisissez un endroit où un approvisionnement en eau peut être facilement relié entre la machine à glaçon et le distributeur automatiques. L'installation du réfrigérateur dans un secteur humide ou humide peut générer de la rouille et peut être un risque électrique.

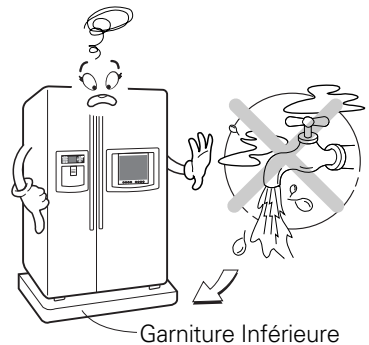

Dans un lieu exempt de source de chaleur, gaz ou charbon

Lieux où la température ambiante a des possibilités d'être élevées augmentant les possibilités d'avoir un mauvais refroidissement et une charge accrue de la consommation d'électricité. Le gaz et la fumée de charbon peuvent décolorer l'aspect du réfrigérateur.

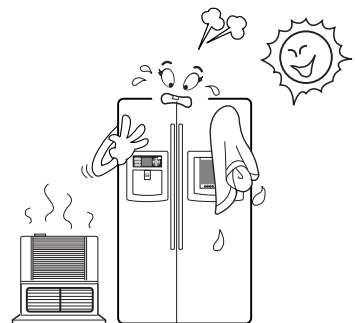

NOTE

- installez le réfrigérateur dans un lieu où la température ambiante est 5°C ~ 43°C (41°F~110°F). La température ambiante en dehors de cette gamme peut causer le défaut de fonctionnement du produit. En outre, le tube entre le distributeur et la machine à glaçon automatique peut geler.

Extraction de la porte

⚠ Attention

Danger de choc électrique

Débranchez la prise de courant du réfrigérateur avant de l'installer.

Si vous ne le faites pas, cela pourrait entraîner des blessures graves ou la mort de la personne qui fait l'installation.

Si votre porte d'entrée est trop étroite pour faire passer le réfrigérateur, enlevez la porte du réfrigérateur et passez-le de côté.

Tirez le couvercle inférieur vers le haut pour l'enlever, puis tirez du tuyau d'arrivée d'eau d'alimentation tout en pressant sur la zone ① comme indiqué sur la figure de la droite.

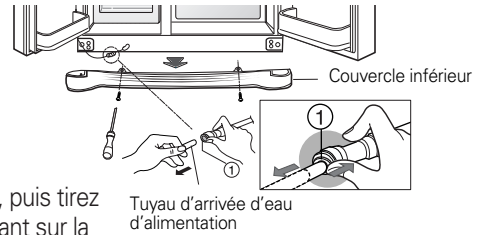

Enlevez le couvercle inférieur et le tuyau d'arrivée d'eau d'alimentation

Extraction de la porte du compartiment du congélateur

NOTE

- Si l'extrémité du tuyau est déformée ou usée, coupez cette partie. Mettre un grand récipient au-dessous de la porte lors du démontage du tube. Sinon environ 1.5L de l'eau coule et détériore le plancher.

- 1) Enlevez le couvercle à charnière en desserrant les vis. Débranchez toutes les connexions, sauf celle de mise à la terre.

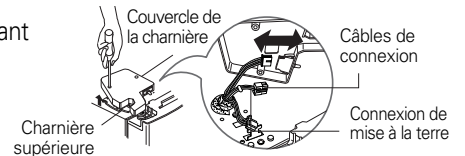

- 2) Enlevez la clavette en la faisant tourner dans le sens contraire des aiguilles d'une montre ① puis tirez la charnière supérieure vers le haut pour la retirer ②.

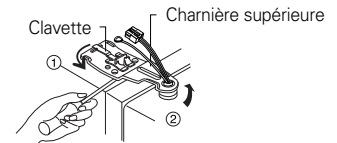

NOTE

- Lorsque vous enlevez la charnière supérieure, faites attention à ce que la porte ne tombe pas en avant.

- 3) Tirez la porte du compartiment du congélateur vers le haut afin de l'enlever. Maintenant, vous devez lever suffisamment la porte pour retirer complètement la tuyauterie d'arrivée d'eau d'alimentation.



NOTE

- Une fois la porte enlevée, placez le réfrigérateur dans la cuisine, à l'endroit où vous allez l'installer. Appuyez-le sur une couverture et prenez soin de ne pas abîmer la tuyauterie d'arrivée d'eau d'alimentation.

Extraction de la porte du réfrigérateur

- 1) Desserrez les vis du couvercle à charnières et retirez le couvercle. Enlevez les câbles de connexion, s'il y en a, sauf le câble de mise à la terre.

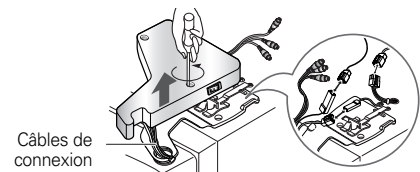

- 2) Enlevez la clavette en la faisant tourner dans le sens des aiguilles d'une montre ① puis tirez la charnière supérieure vers le haut pour la retirer ②.

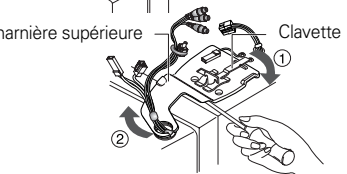

- 3) Tirez la porte du compartiment du réfrigérateur vers le haut pour la retirer.

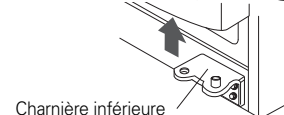

Passez le réfrigérateur

Passez le réfrigérateur latéralement par la porte d'accès comme représenté sur la bonne figure.

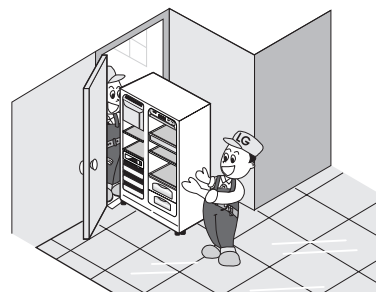

Montez les portes à compartiment du congélateur et du réfrigérateur

Montez-les dans l'ordre d'inversion du déplacement après avoir passée la porte d'accès.

Installation d'approvisionnement en eau

Avant l'installation

- L'opération automatique de la machine à glaçon a besoin de la pression de l'eau de 21~121 livre par pouce carré (psi)(1.5~8.5 kgf/cm²) (c'est-à-dire, une tasse de papier instantanée (180 cc) sera entièrement remplie en moins de 3 sec).
- Si la pression de l'eau n'atteint pas l'estimation 21 livres par pouce carré (1,5 kgf/cm²) ou en dessous, il est nécessaire d'acheter une pompe de pression séparée pour la fabrication automatique de glace correcte et une alimentation normal en eau fraîche.
- Gardez toute la longueur du tube de conduite d'eau d'alimentation dans 26' (8 m) et faites attention que le tube ne soit pas plié. Si le tube est de 26' (8 m) ou plus grand il peut causer des problèmes d'alimentation en eau dû à la pression de l'eau de drain.
- Installez le tube de conduite d'eau d'alimentation dans un endroit exempt de la chaleur.

Attention

- Reliez à l'approvisionnement en eau potable seulement.

Disposition a prendre pour le vieil appareil

Cet appareil contient des fluides (réfrigérant, lubrifiant) et est fait de pièces et matériaux qui sont réutilisables et/ou recyclables.

Tous les matériaux importants devraient être envoyés au centre de recollection des déchets et peuvent être réutilisés après recyclage (réutilisation). Pour le recyclage, entrez en contact svp avec l'agence locale.

Connexion du réfrigérateur à une source d'eau

Attention

Instructif pour la connexion d'eau

Lisez attentivement les instructions avant de commencer.

Raccordez seulement à une canalisation d'eau potable.

IMPORTANT

- Si le réfrigérateur est mis en marche avant l'installation de la connexion d'eau, placez la glacière sur la position **OFF** afin d'éviter qu'elle marche sans eau.
- Toutes les installations doivent être effectuées conformément aux conditions requises par le code de plomberie local.
- Utilisez des tubes de cuivre et contrôlez qu'il n'y a pas de fuites.
- Installez les tubes de cuivre seulement dans des endroits où la température reste au-dessus du point de congélation.
- Il faudra probablement attendre 24 heures pour que la glacière automatique commence à produire de la glace.

Outils nécessaires

- Tournevis standard
- Clés plates de 7/16 pouces et 1/2 pouces ou deux clés anglaises
- Tournevis à douille de 1/4 pouces
- Foret de 1/4 pouces.
- Chignole ou perceuse électrique (correctement reliées à la terre)

NOTE

- Le consignataire de votre réfrigérateur peut vous offrir un jeu d'outils avec un robinet de sectionnement du type selle de renfort de 1/4 pouces, un raccord et des tubes de cuivre. Avant de l'acheter, assurez-vous que le robinet de sectionnement du type selle de renfort respecte vos codes de plomberie locaux. N'utilisez de robinet autoperceur ni de robinet de sectionnement de 3/16 pouces, qui réduiraient le flux d'eau et se boucheraient plus facilement.

Alimentation en eau froide

Le robinet d'adduction d'eau de la glacière automatique comporte une rondelle de réglage débit qui est employée comme un régulateur de la pression d'eau.

La glacière doit être raccordée à une conduite d'eau froide ayant une pression d'eau de 20~120 psi(lb/po²).

S'il y a des problèmes, téléphonez à votre fournisseur de service public.

Connexion du tuyau à la conduite d'eau

1. Débranchez le réfrigérateur ou coupez le courant.
2. Fermez la source principale d'eau. Ouvrez le robinet le plus proche le temps nécessaire pour libérer la pression de la tuyauterie. Il est utile d'ouvrir une prise d'eau extérieure afin de permettre le drainage par les conduites d'eau de la maison.
3. Identifiez une conduite d'eau FROIDE verticale de 1/2 pouces à 1-1/4 pouces qui soit près du réfrigérateur.

NOTE

- Une conduite horizontale peut également être utile, mais vous devez prendre la précaution suivante: percez dans la partie supérieure du tuyau, jamais dans la partie inférieure. Ceci vous aidera à maintenir l'eau éloignée de la perceuse. Ceci empêchera en plus le sédiment normal de se déposer sur le robinet.

4. Pour déterminer la longueur du tube de cuivre dont vous aurez besoin, mesurez depuis la connexion de la partie arrière inférieure du réfrigérateur jusqu'à la canalisation d'eau. Ajoutez-y 7 pieds (2.1m) afin de permettre le déplacement du réfrigérateur pour le nettoyage. Utilisez des tubes de cuivre de 1/4 po de diamètre extérieur. Assurez-vous que les deux extrémités du tuyau en cuivre ont été correctement coupées.
5. A l'aide d'une perceuse reliée à la terre, percez un trou de 1/4 pouces sur la conduite d'eau froide choisie.
6. Fixez le robinet de sectionnement sur la conduite d'eau froide à l'aide d'un collier de tuyau. Assurez-vous que l'extrémité de la prise est fermement fixée au trou de 1/4 pouces effectué sur la conduite d'eau et que la rondelle est au-dessous du collier. Serrez les écrous de presse garniture. Serrez bien les vis du collier afin que la rondelle joue le rôle d'un scellage imperméable. Ne serrez pas de trop car vous pourriez casser le tube de cuivre, en particulier si vous utilisez des tuyaux souples de cuivre (spiralés). C'est déjà prêt pour raccorder le tube de cuivre.
7. S'Glissez le manchon à comprimer et l'écrou de serrage du tube de cuivre comme indiqué sur la figure.
Placez l'extrémité du tube dans la prise aussi profondément que possible. Serrez l'écrou de serrage sur l'extrémité de la prise à l'aide d'une clé anglaise. Ne le serrez pas de trop.
8. Placez l'extrémité libre du tube dans un récipient ou déversoir, ouvrez l'alimentation d'eau de la source principale et purgez le tube jusqu'à ce que l'eau soit claire. Fermez le robinet de sectionnement de la conduite d'eau. Enroulez le tube de cuivre comme indiqué plus bas.

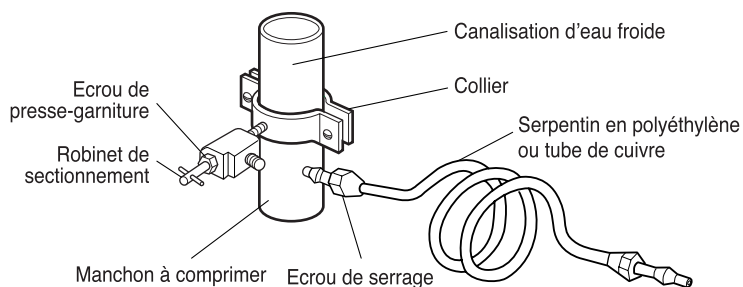

Raccordez la tuyauterie au réfrigérateur

Avant de faire la connexion au réfrigérateur, vérifiez que le câble d'alimentation n'est pas branché à la prise de courant murale.

- Si votre réfrigérateur n'a pas de filtre à eau, nous vous recommandons d'en installer un. Si l'eau fournie a du sable ou des particules pouvant obstruer le filtre du robinet d'adduction d'eau du réfrigérateur, installez le filtre sur la conduite d'eau près du réfrigérateur.

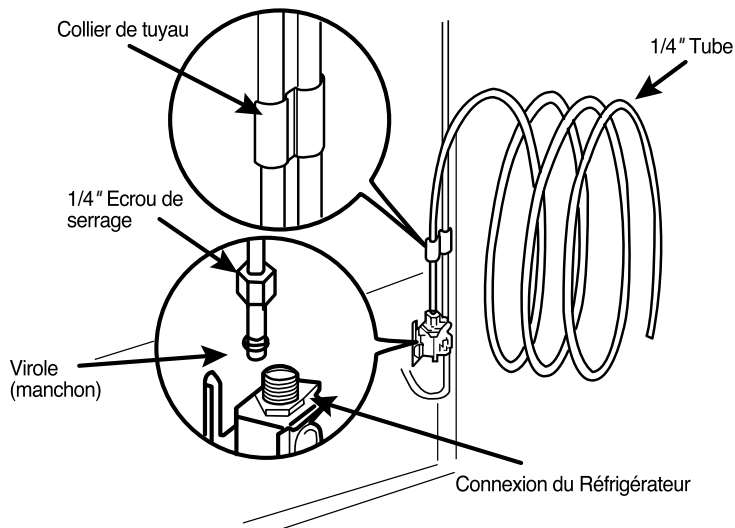

1. Enlevez la bague en plastique flexible du robinet d'adduction d'eau.
2. Placez l'écrou de serrage et la virole (manchon) à extrémité du tuyau comme indiqué sur la figure.
3. Placez extrémité du tube de cuivre dans la connexion aussi loin que possible. Tout en fixant la tuyauterie, serrez le connecteur.

Ouvrez le passage de l'eau à l'aide du robinet de sectionnement

Serrez bien tout raccord ayant des fuites.

■ Branchez le réfrigérateur

Rangez le serpentín de tube de cuivre de manière à ce qu'elle ne provoque pas de vibration contre la partie arrière du réfrigérateur ou contre le mur. Remplacez le réfrigérateur contre le mur.

■ Mettez en marche la glacière automatique

Placez l'interrupteur de la glacière sur la position ON. La glacière ne démarrera qu'après avoir atteint sa température de fonctionnement de 15 °F (-9 °C) ou moins. Ensuite, elle démarrera automatiquement si l'interrupteur est sur la position ON.

Ajustement de la taille

**Si la porte
compartimentée du
congélateur est plus
basse que la porte
compartimentée du
réfrigérateur**

Faites les niveaux en insérant le conducteur plat (- type) t dans la cannelure de la vis de réglage de hauteur gauche et en le tournant dans le sens des aiguilles d'une montre (⌚).

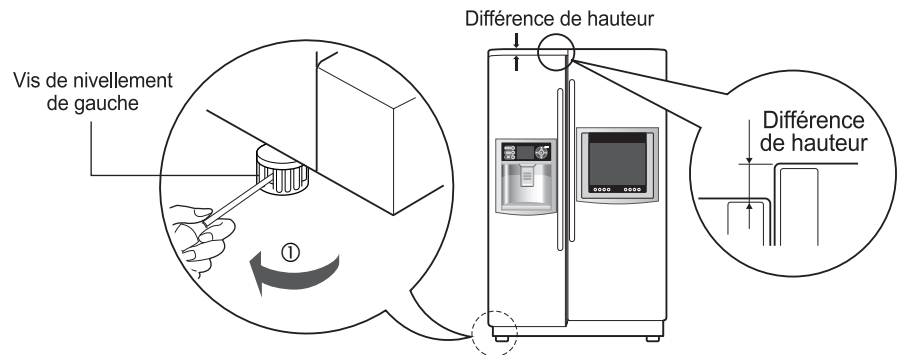

**Si la porte
compartimentée du
congélateur est plus
haute que la porte
compartimentée du
réfrigérateur**

Faites les niveaux en insérant le conducteur plat (- type) t dans la cannelure de la vis de réglage de hauteur droite et en le tournant dans le sens des aiguilles d'une montre (⌚).

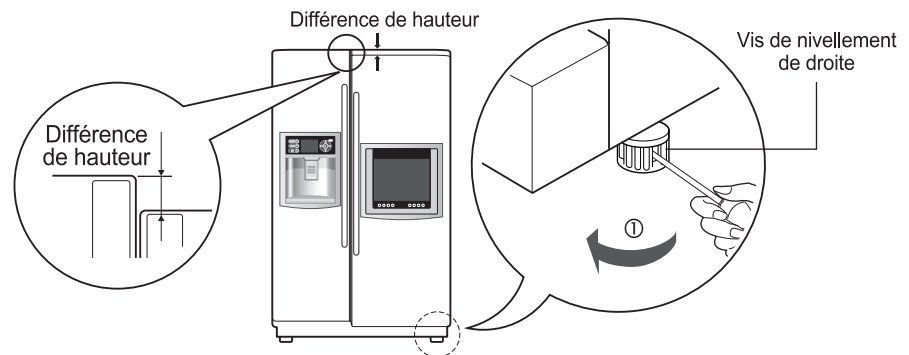

**Après mise à niveau
de la hauteur de port**

La porte du réfrigérateur se fermera sans à-coup en soulevant la partie antérieure et en ajustant la vis de réglage de hauteur.

Connexions d'équipement externe

Connexion de l'antenne

- Connexions de l'antenne ou du service de câblodistribution sans boîte de jonction.
- Réglez la direction de l'antenne, si besoin, pour obtenir une qualité d'image optimale.

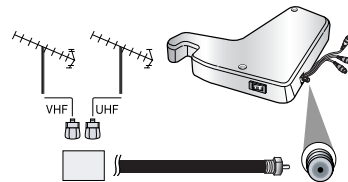
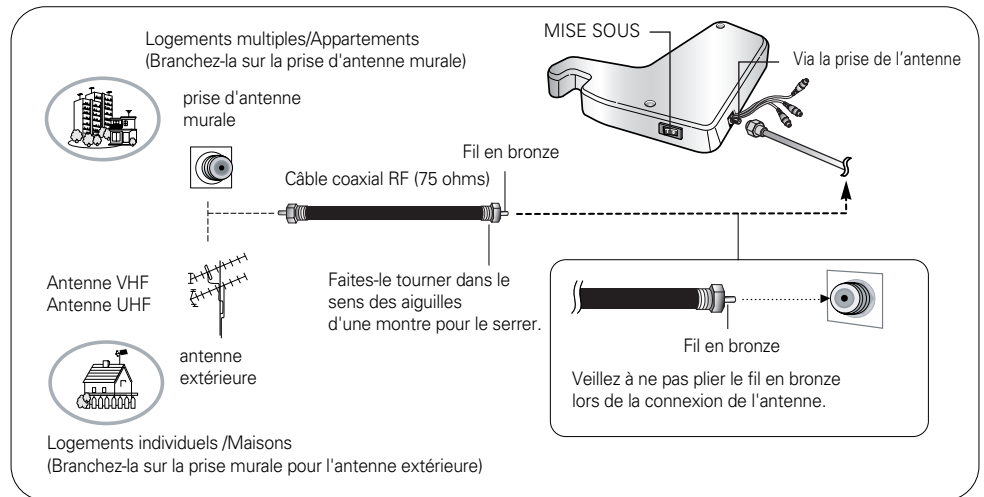

- Pour améliorer la qualité de l'image dans une zone de mauvaise réception, achetez et installez un amplificateur de signal.
- Si l'antenne n'est pas installée convenablement, contactez votre revendeur.

Prises d'entrée VCR / DVD

Connexion

1. Raccordez les prises de sortie audio et vidéo du magnétoscope aux prises d'entrée audio/vidéo du téléviseur.
2. Appuyez sur la touche **TV/AV/RADIO** pour sélectionner **AV**.
3. Appuyez sur la touche de lecture (**PLAY**) du magnétoscope. L'image lue sur le magnétoscope apparaît à l'écran.

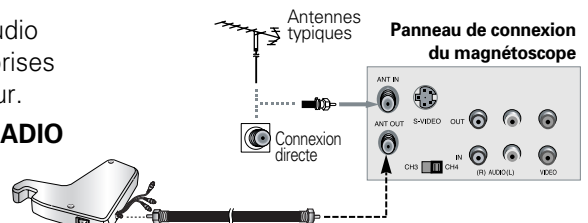

NOTE

- Si votre magnétoscope ne dispose que d'une sortie mono, vous devrez connecter ce dernier à la prise **AUDIO L/MONO** gauche située du téléviseur.

Raccordement au réseau câblé

- Après vous être abonné au service Câble auprès de votre fournisseur, et une fois votre boîtier de raccordement installé, vous êtes en mesure de regarder les chaînes câblées.
- Pour plus d'information sur le système de câblodistribution, contactez un fournisseur local du service de câblodistribution.

Connexion

1. Appuyez sur la touche **TV/AV/RADIO** de la télécommande, puis sélectionnez **TV**.
2. Sélectionnez la chaîne de votre choix à l'aide de la télécommande du boîtier de raccordement. (Pour de plus amples informations sur le service Câble, contactez votre fournisseur de services.)

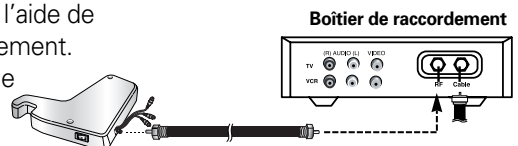

Démarrage

Lorsque votre réfrigérateur est installé pour la première fois, laissez-le stabiliser les températures de fonctionnement normales pendant 2-3 heures avant de le remplir avec des aliments frais ou surgelés.

Si le fonctionnement est interrompu, attendez 5 minutes avant de le faire redémarrer.

Réglage des températures et des fonctions

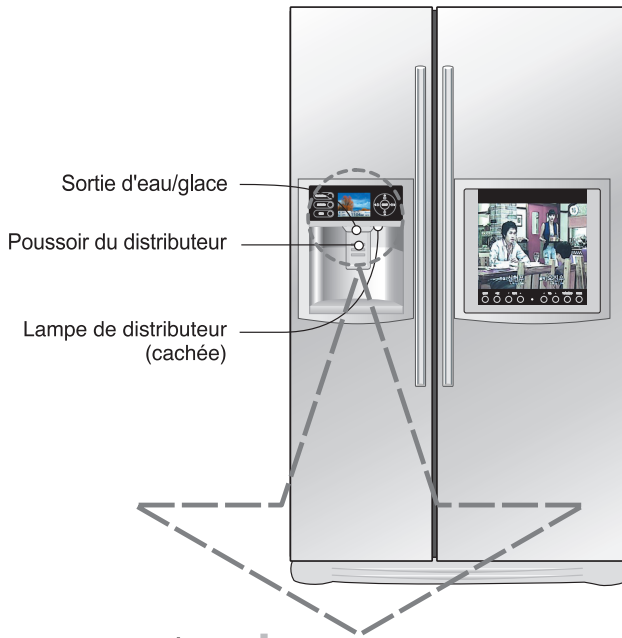

A propos des pixels défectueux

Cet écran LCD contient des centaines de milliers de pixels.

Les écrans LCD présentent habituellement quelques pixels défectueux. Votre écran a été contrôlé et est en conformité avec les spécifications du fabricant, ce qui signifie que les éventuels défauts de pixel n'affecteront pas les conditions normales d'utilisation du produit.

Sur un écran de cette taille, la présence de moins de 4 pixels défectueux est considérée comme normale, et ne peut donner lieu au remplacement ou au remboursement.

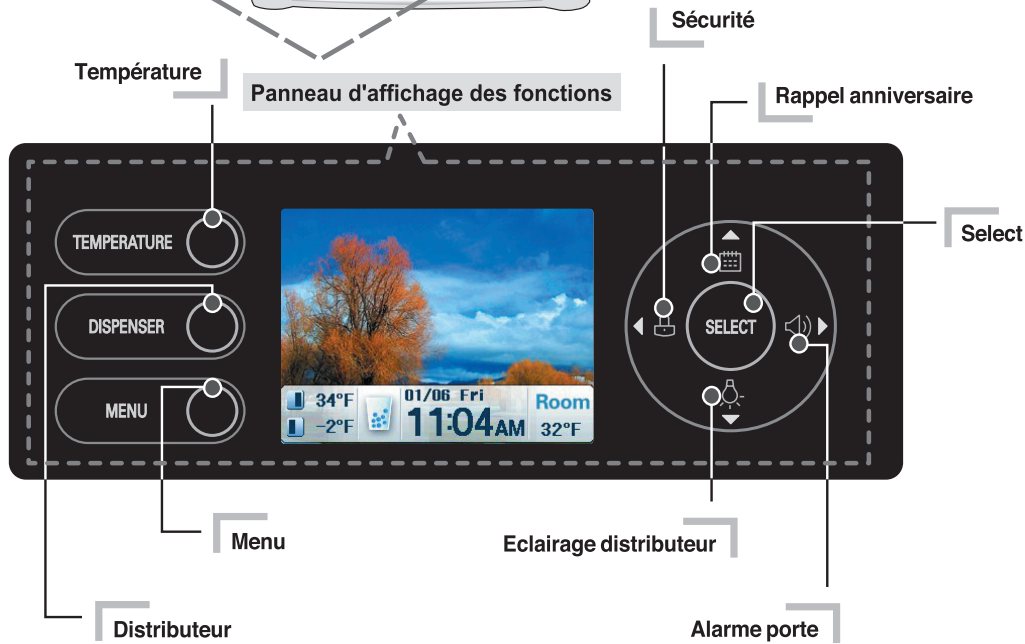

NOTE

- Votre modèle peut ne pas inclure toutes les options.

Température

Réfrigérateur/ Congélateur

- Vous pouvez régler la température du congélateur et du réfrigérateur.

1

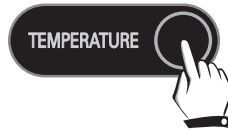

Appuyez sur le bouton
TEMPERATURE.

2

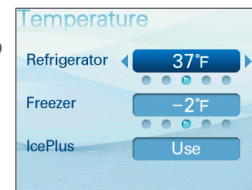

A l'aide des boutons ▲ et ▼,
sélectionnez le système de
refroidissement désiré.

3 Régler la température à l'aide des boutons ◀ ou ▶.

Options de température du réfrigérateur: 46, 41, 37, 34, ou 32°F

Options de température du congélateur: 7, 1, -2, -5, ou -8°F

4 Appuyez sur le bouton **SELECT.**

5 Retournez à l'écran de veille.

Ice Plus froid extrême

- Pour refroidissement rapide.

- L'écran de veille apparaît lors des opérations **IcePlus** IcePlus.

1

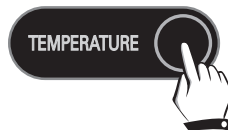

Appuyez sur le bouton
TEMPERATURE.

2

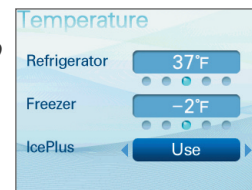

Appuyez sur la touche ▲ ou ▼ pour
sélectionnez **IcePlus.**

3 Appuyez sur la touche ◀ ou ▶ pour
sélectionner **Use.**

[Use] <--> [Not in Use]

4 Appuyez sur le bouton
SELECT.

5

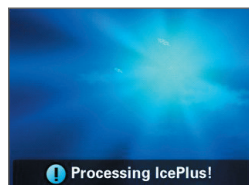



6 Retournez à l'écran de veille.

- La température indiquée ne correspond pas à la température réelle à l'intérieur du réfrigérateur mais à la température souhaitée. La température interne réelle peut différer, particulièrement si la porte est ouverte et que des plats chauds viennent d'être déposés.

- A l'origine, le refroidissement est faible. Réglez la température comme indiqué ci-dessus après 2 à 3 jours d'utilisation au moins.

Distributeur

Ecrasement/ Eau/Cube

- Vous pouvez choisir parmi les options écrasement, eau ou cube.
- Quand le distributeur fonctionne, l'option courante est indiquée dans l'écran de veille.
- Ecrasement , Eau , Cube .



Appuyez sur le bouton **DISPENSER**.

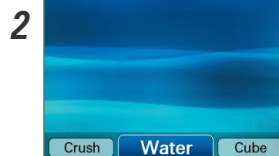

A l'aide des boutons ◀ ou ▶, sélectionnez l'option souhaitée.

[**Crush**] <--> [**Water**] <--> [**Cube**]

3 Appuyez sur le bouton **SELECT**.

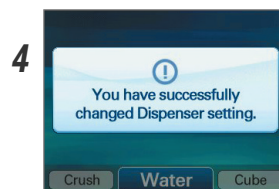

5 Retournez à l'écran de veille.

Glacière automatique

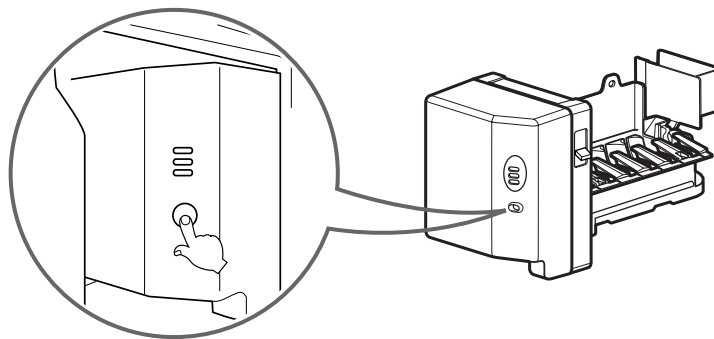

- La glacière automatique peut produire 8 pièces de glaçons en même temps, c'est-à-dire, 70-120 pièces par jour. Mais ces quantités peuvent varier suivant de diverses conditions, y inclus le nombre de fois d'ouverture et fermeture de la porte du réfrigérateur.
- La glacière s'arrête lorsque le bac à stockage de glaçons est plein.
- Si vous ne désirez pas employer la glacière automatique, placez l'interrupteur de la glacière automatique sur la position ON-OFF.
Si vous désirez utiliser de nouveau la glacière automatique, placez l'interrupteur sur la position OFF-ON.

NOTE

- Il est normal qu'un bruit se produise lorsqu'un glaçon tombe dans le bac à de stockage de glaçons.

Menu

Vous avez le choix entre les fonctions Information, Recettes, Réfrigérateur, Réglage écran et Album Photo.



Appuyez sur le bouton **MENU**.



3 Aidez-vous des boutons ▲ & ▼, pour faire apparaître le menu.

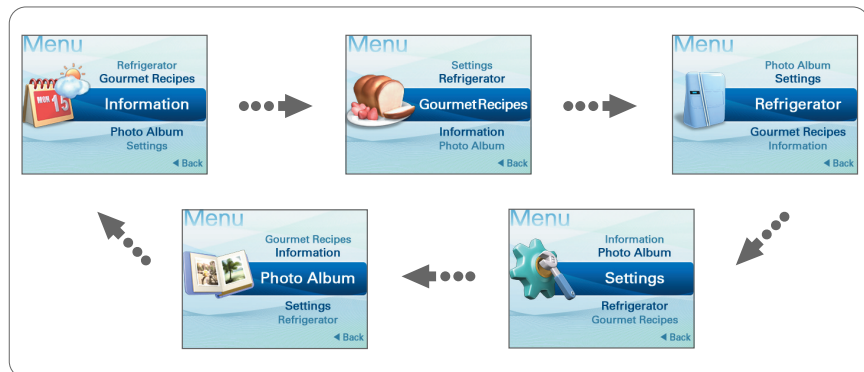

4 Appuyez sur le bouton **SELECT**.

5 Vous obtiendrez un menu détaillé.

Informations

Vous pouvez choisir parmi les fonctions Prévisions météo, Rappel anniversaire, Réglage date et heure, ou Minuteur.

☐ **Prévisions météo**

- Recevez et affichez les infos météo sur 5 jours.
- La réception des informations sur les prévisions météorologiques reçues et affichées à l'écran est sujette à des modifications en fonction de votre région et de l'emplacement du réfrigérateur.
- De ce fait, LG ne garantit pas et ne sera pas tenu responsable de l'exactitude de l'information météorologique.
- Les informations sur les prévisions météorologiques ne sont disponibles qu'aux Etats-Unis.



Appuyez sur la touche ▲ ou ▼ pour sélectionner **Weather Forecast**.



Appuyez sur la touche ◀ ou ▶ pour sélectionner **On/Off**.

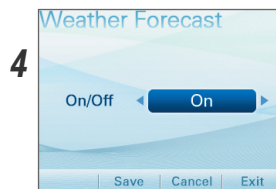

Appuyez sur la touche ◀ ou ▶ pour sélectionner **On**.



Sélectionnez la région désirée à l'aide des boutons ◀ ou ▶.



7 Retournez au menu **Information**.

☐ **Rappel anniversaire**

- Register the anniversary date.
-  Sélectionnez la rappel anniversaire à l'aide du bouton.

< **Pour régler une nouvelle date.** >



Appuyez sur la touche ▲ ou ▼ pour sélectionner **Anniversary Reminder**.



Sélectionnez le mois à l'aide des boutons ◀ ou ▶.

Appuyez sur le bouton ▼ et insérez la date à l'aide des boutons ◀ ou ▶.



Aidez-vous des boutons ▲ ou ▼, pour faire apparaître le menu

Sélectionnez la période à l'aide des boutons ◀ ou ▶.



Appuyez sur la touche ▼ pour sélectionner **Save**.

6 Retournez au menu **Information**.

L'alarme de rappel des anniversaires se déclenche.



L'alarme se déclenche à la date et à l'heure fixée et l'anniversaire sera affiché à l'écran.

< Pour voir la liste des dates d'anniversaire >



Appuyez sur la touche ▲ ou ▼ pour sélectionner **Anniversary Reminder**.



Appuyez sur la touche ▲ ou ▼ pour sélectionner **List**.



Vous pouvez contrôler le menu détaillé à l'aide des boutons ◀ ou ▶.

☐ **Réglage date & heure**

Pour régler la date et l'heure.



Appuyez sur la touche ▲ ou ▼ pour sélectionner **Data & Time Setting**.



Aidez-vous des boutons ▲ ou ▼, pour faire apparaître le menu.

Sélectionnez la valeur à l'aide des boutons ◀ ou ▶.



Appuyez sur la touche ▼ pour sélectionner **Save**.

5 Retournez au menu **Information**.

☐ Minutrie

Pour régler l'alarme:



Appuyez sur la touche ▲ ou ▼ pour sélectionner **Timer**.

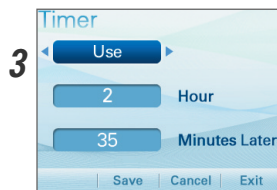

Sélectionnez l'heure à l'aide des boutons ◀ ou ▶.

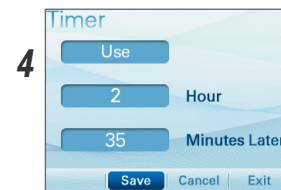

Appuyez sur la touche ▼ pour sélectionner **Save**.

5 Retournez au menu **Information**.

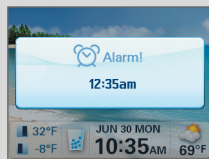

- L'alarme se déclenche à l'heure réglée, et l'icône du temporisateur s'affichera à l'écran.

Recettes

Sélectionnez la recette après avoir choisi le type de plat.



Sélectionnez le type à l'aide des boutons ▲ ou ▼.



Vous pouvez sélectionner le menu détaillé à l'aide des boutons ◀ ou ▶.



Appuyez sur la touche ▼ pour sélectionner **More**.



Vous pouvez sélectionner le plat à l'aide des boutons ◀ ou ▶.

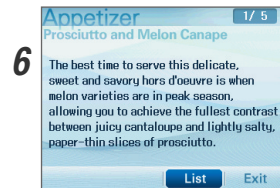

Appuyez sur la touche ▼ pour sélectionner **List**.

7 Retournez au menu **Gourmet Recipes**.

Réfrigérateur

Vous avez le choix entre les fonctions Initialisation filtre, Alarme porte, Lumière distributeur, Manuel et appel de Service.

☐ **Initialisation filtre**

Notez la date de remplacement du filtre.

< **Quand la date de remplacement du filtre n'est pas dépassée.** >



Appuyez sur la touche ▲ ou ▼ pour sélectionner **Filter Reset**.

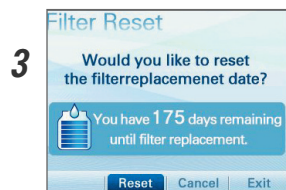

Appuyez sur la touche ◀ ou ▶ pour sélectionner **Reset**.

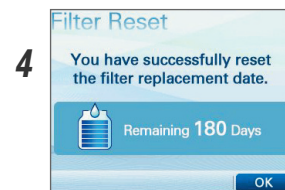

Appuyez sur le bouton **SELECT**.

5 Retourner au menu **Refrigerator**.

< Lorsque la date de remplacement du filtre est dépassée. Refrigerator. >



Appuyez sur la touche ▲ ou ▼ pour sélectionner **Filter Reset**.



Appuyez sur la touche ◀ ou ▶ pour sélectionner **Reset**.

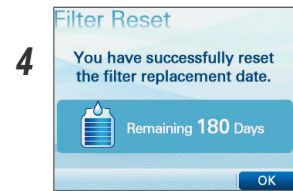

Appuyez sur le bouton **SELECT**.

5 Retourner au menu **Refrigerator**.

- Vous apercevrez un message vous invitant à remplacer le filtre lorsque la date d'échange du filtre est courante.



Appuyez sur la touche ◀ ou ▶ pour sélectionner **Reset**.



Appuyez sur le bouton **SELECT**.

Retournez à l'écran de veille.

- Si vous souhaitez annuler les réglages du remplacement du filtre.



Appuyez sur la touche ◀ ou ▶ pour sélectionner **Later**.

Appuyez sur le bouton **SELECT**.



Vous apercevrez l'icône de remplacement du filtre dans l'écran de veille.

☐ **Alarme porte/tiroir**

Cette fonction vous avertit toutes les 30 secondes que la porte du réfrigérateur est ouverte depuis plus d'une minute.

-  Vous pouvez activer/désactiver l'alarme de la porte.

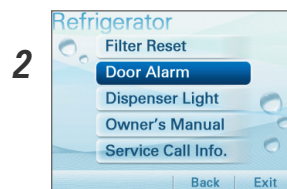

Appuyez sur la touche ▲ ou ▼ pour sélectionner **Door Alarm**.

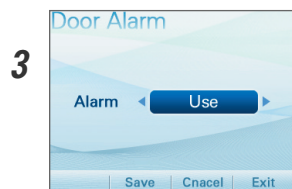

Appuyez sur la touche ◀ ou ▶ pour sélectionner **Use** ou **Not in Use**.

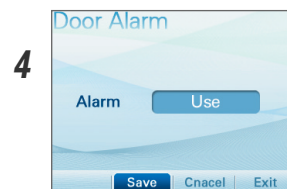

Appuyez sur la touche ▼ pour sélectionner **Save**.

5 Retourner au menu **Refrigerator**.

- Vous verrez apparaître le message d'alarme de la porte.

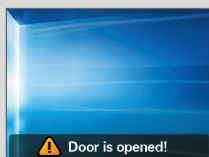

- **Lorsque vous utilisez l'Alarme porte**

Cette fonction vous avertit toutes les 30 secondes que la porte est ouverte depuis plus d'une minute.

- **Lorsque vous n'utilisez pas l'Alarme porte**

L'alarme ne se déclenchera pas même si la porte du réfrigérateur est ouverte.

☐ **Eclairage distributeur**

Cette fonction contrôle les diodes LED du distributeur.

-  Une pression sur l'icône commence l'éclairage du distributeur.



Appuyez sur la touche ▲ ou ▼ pour sélectionner **Dispenser Light**.

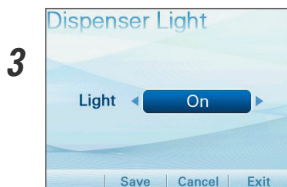

Appuyez sur la touche ◀ ou ▶ pour sélectionner **On**.

[On] <--> [Off]

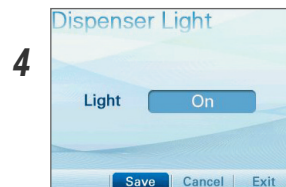

Appuyez sur la touche ▼ pour sélectionner **Save**.

5 Retourner au menu **Refrigerator**.

- **Lorsque On est sélectionné**, l'éclairage du distributeur est toujours activé.
- **Lorsque Off est sélectionné**, l'éclairage du distributeur est activé uniquement lorsque le levier du distributeur est pressé.

☐ Manuel

Vous pouvez sélectionner à l'aide des touches de sélection, Réglage température, Sécurité enfant, prévisions météo, Guide de maintenance du Frigo, Guide de maintenance congélateur ou Elimination des odeurs.

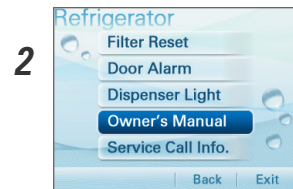

Appuyez sur la touche ▲ ou ▼ pour sélectionner **Owner's Manual**.

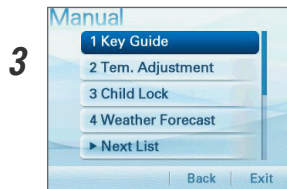

Sélectionner le menu à l'aide des boutons ▲ ou ▼.

4 Appuyez sur le bouton **SELECT**.

5 Sélectionnez le menu détaillé à l'aide des boutons ◀ ou ▶.

6 Appuyez sur la touche ▼ pour sélectionner **List**.

7 Retourner au menu **Refrigerator**.

1. Guide clé

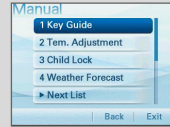

Appuyez sur la touche ▲ ou ▼ pour sélectionner **Key Guide**.

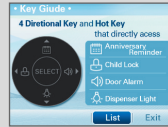

Vous obtiendrez un menu détaillé.

2. Réglage température

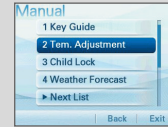

Appuyez sur la touche ▲ ou ▼ pour sélectionner **Temp. Adjustment**.



Vous pouvez contrôler le menu détaillé à l'aide des boutons ◀ ou ▶.

3. Sécurité enfant

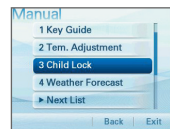

Appuyez sur la touche ▲ ou ▼ pour sélectionner **Child Lock**.

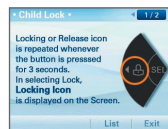

Vous pouvez contrôler le menu détaillé à l'aide des boutons ◀ ou ▶.

4. Prévisions météo

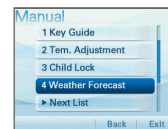

Appuyez sur la touche ▲ ou ▼ pour sélectionner **Weather Forecast**.



Vous pouvez contrôler le menu détaillé à l'aide des boutons ◀ ou ▶.

5. Stockage Approprié De Nourriture

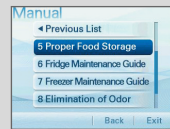

Appuyez sur la touche ▲ ou ▼ pour sélectionner **Proper Food Storage**.



Vous pouvez contrôler le menu détaillé à l'aide des boutons ◀ ou ▶.

6. Guide de maintenance réfrigérateur

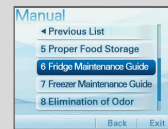

Appuyez sur la touche ▲ ou ▼ pour sélectionner **Fridge Maintenance Guide**.

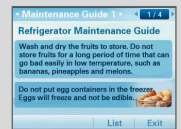

Vous pouvez contrôler le menu détaillé à l'aide des boutons ◀ ou ▶.

7. Guide de maintenance congélateur

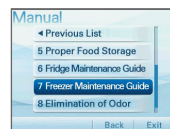

Appuyez sur la touche ▲ ou ▼ pour sélectionner **Freezer Maintenance Guide**.



Vous pouvez contrôler le menu détaillé à l'aide des boutons ◀ ou ▶.

8. Elimination des odeurs



Appuyez sur la touche ▲ ou ▼ pour sélectionner **Elimination of Odor**.

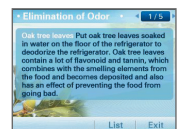

Vous pouvez contrôler le menu détaillé à l'aide des boutons ◀ ou ▶.

☐ **Service d'assistance**

Cette fonction vous donne le numéro du service d'assistance américain et canadien.

1



2



Appuyez sur la touche ▲ ou ▼ pour sélectionner **Service Call Info.**

3



Vous obtiendrez un menu détaillé.

**Affichage—
Paramètre**

Vous avez le choix parmi les fonctions Mode d'affichage, Thème visuel, Mise en veille, Rétro éclairage/Bouton son et °C/F Parametre.

1



2



Sélectionnez le menu à l'aide des boutons ▲ ou ▼ .

3



Sélectionnez et sauvegardez le menu désiré à l'aide des boutons ◀ ou ▶ .

4 Retourner au menu **Settings**.

☐ **Affichage – Mode**

Vous pouvez sélectionner les réglages de l'écran de veille.



Appuyez sur la touche ▲ ou ▼ pour sélectionner **Display Image**.



Vous pouvez contrôler l'écran de veille à l'aide des boutons ◀ ou ▶.

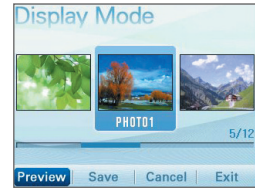

Sélectionnez la photo désirée à l'aide des boutons ◀ ou ▶.

Appuyez sur la touche ▼ pour sélectionner **Preview**.

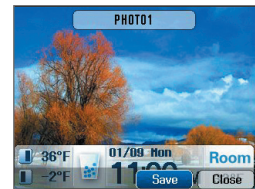

Appuyez sur la touche ▼ pour sélectionner **Save**.

☐ **Affichage – Thème**

Vous pouvez sélectionner les réglages du thème visuel.

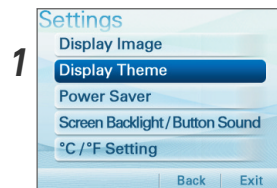

Appuyez sur la touche ▲ ou ▼ pour sélectionner **Display Theme**.

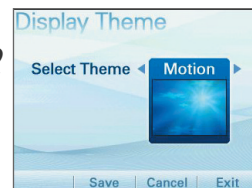

Sélectionnez le menu à l'aide des boutons ◀ ou ▶.

Appuyez sur la touche ▼ pour sélectionner **Save**.

[Character] <-> [Motion]

☐ **Mise en veille**

Vous pouvez sélectionner la fonction de mise en veille.

< Lorsque la fonction de mise en veille est sélectionnée. >

- Lorsque vous sélectionnez l'option [Activer la fonction Économie d'énergie], le rétroéclairage de l'écran à cristaux liquides s'éteint après éclipse du temps indiqué.

1



Appuyez sur la touche ▲ ou ▼ pour sélectionner **Power Saver**.

2



Appuyez sur la touche ◀ ou ▶ pour sélectionner **Use**.

3



Sélectionnez le délai souhaité avant mise en veille à l'aide des boutons ◀ ou ▶.
[1min] <--> [3min] <--> [5min]

4 La mise en veille désactive l'écran au bout du délai pré réglé.

< Lorsque la fonction mise en veille n'est pas sélectionnée. >

- Lorsque vous sélectionnez l'option [Activer la fonction Économie d'énergie], le protecteur de l'écran à cristaux liquides s'active au bout d'une minute.

1



Appuyez sur la touche ▲ ou ▼ pour sélectionner **Power Saver**.

2



Appuyez sur la touche ◀ ou ▶ pour sélectionner **Not in Use**.

3



Aidez-vous des boutons ◀ ou ▶, pour faire apparaître le menu.



[Clock]



[Photo]



[Not in Use]

Lorsque vous sélectionnez l'option [Hors service], l'écran veille actuel est sauvegardé en tant qu'économiseur d'écran.

☐ **Rétro éclairage/Bouton son**

- Lors de sélectionner le bouton, vous pouvez régler le son d'alarme.
- Sélectionnez la touche SON (SOUND) pour activer ou désactiver le son.

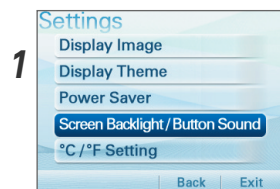

Appuyez sur la touche ▲ ou ▼ pour sélectionner **Screen Backlight/Button Sound**.

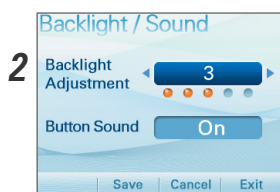

Sélectionnez une valeur de luminosité à l'aide des boutons ◀ ou ▶.

Appuyez sur la touche ▼ pour sélectionner **Save**.

[1 <--> 2 <--> 3 <--> 4 <--> 5]

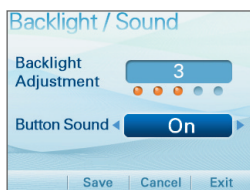

Sélectionnez et sauvegardez le menu désiré à l'aide des boutons ◀ ou ▶.

[On] <--> [Off]

☐ **°C/°F Parametre**



Appuyez sur la touche ▲ ou ▼ pour sélectionner **°C/°F Setting**.



Sélectionnez une valeur de luminosité à l'aide des boutons ◀ ou ▶.

[Centigrade] <--> [Fahrenheit]

Appuyez sur la touche ▼ pour sélectionner **Save**.

Album photo

Vous pouvez enregistrer une photo ou régler l'écran de veille.

< En réglant l'écran de veille. >

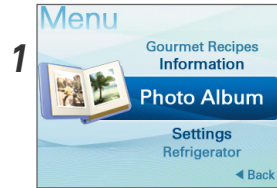

Sélectionner la photo désirée à l'aide des boutons ◀ ou ▶.

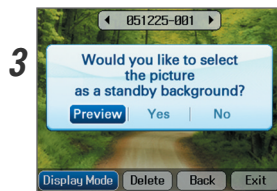

Appuyez sur la touche ▼ pour sélectionner **Display Image**.

Appuyez sur la touche ◀ or ▶ pour sélectionner **Preview**.



Appuyez sur la touche ◀ ou ▶ pour sélectionner **Save**.

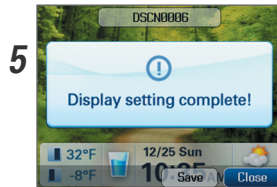

6 Retournez à l'écran de veille.

< En effaçant >

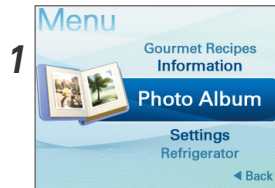

Sélectionnez la photo désirée à l'aide des boutons ◀ ou ▶.

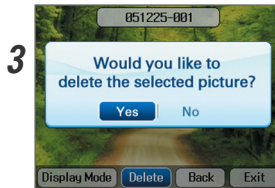

Appuyez sur la touche ▼ pour sélectionner **Delete**.
Appuyez sur la touche ◀ ou ▶ pour sélectionner **Yes**.

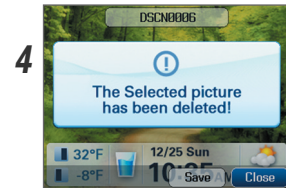

Appuyez sur la touche ◀ ou ▶ pour sélectionner **Save**.

5 Retournez à l'écran de veille.

< En effaçant entier >

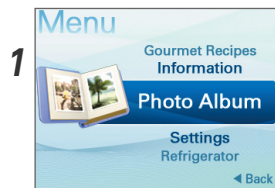

Appuyez sur la touche ▼ pour sélectionner **Delete All**.



Appuyez sur la touche ◀ ou ▶ pour sélectionner **Yes**.

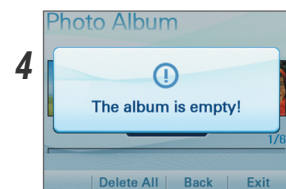

Retournez à l'écran de veille.

<En enregistrant une photo >



Lorsque vous raccordez un USB au port USB, celui-ci lit les données photographiques et ajoute la liste des albums.

< En utiliser le port USB >



Lorsque vous sélectionnez **Photo Album** et puis vous raccordez le port USB, l'option **Import** est activée.



Lorsque vous sélectionnez l'option **Import**, les données du port USB sont lues. Une fenêtre pop-up s'affiche pour vous renseigner sur le processus de progression pendant la lecture.

Une fois que vous avez sélectionné la photo désirée à partir des données lues, sélectionnez l'option **Import**.



Après affichage de l'écran popup **Import Check**, vous pouvez vérifier la photo depuis la liste d'albums photos.

- Position du port USB pour le réfrigérateur.

- Si vous souhaitez utiliser le port USB, sélectionnez d'abord l'option album photos et raccordez ensuite le port USB.

- La lecture des photos depuis le port USB prend plusieurs secondes.

- Il se peut que votre port USB ne soit pas compatible de temps à autre.

- Utilisez le produit dont la photo est sauvegardée dans le USB. Si aucune photo n'est sauvegardée, sauvegardez tout d'abord des photos dans le port USB.



Sécurité

Utilisez pour verrouillez les autres boutons.

-  Sélectionnez Verrouiller à l'aide des boutons.
- Verrouillez ou déverrouillez les touches et le distributeur en enfonçant la touche pendant 3 secondes.
- Lorsque la position de verrouillage est sélectionnée, le distributeur et les touches seront bloqués et ne fonctionneront pas.
- Lorsque la position de verrouillage est sélectionnée, l'icône de verrouillage s'affiche à l'écran.

< Pour activer la sécurité: >

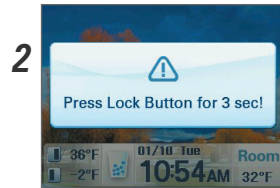
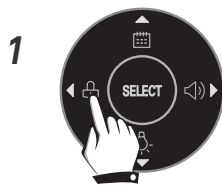

Lorsque vous apercevez ce message, appuyez sur le bouton de verrouillage pendant trois secondes.

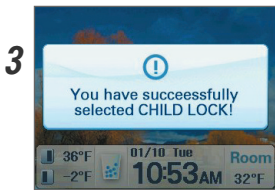

Vous apercevrez ce message.

4 Retournez à l'écran de veille.

< Pour déverrouiller. >

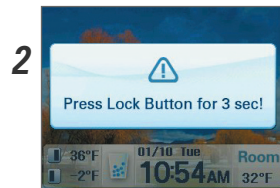
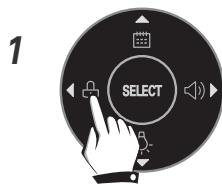

Lorsque vous apercevez ce message, appuyez sur le bouton de verrouillage pendant trois secondes.

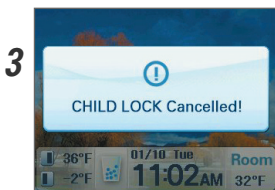

Vous apercevrez ce message.

4 Retournez à l'écran de veille.

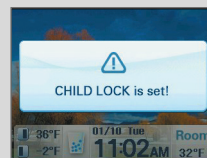

L'appui sur le bouton Réfrigérateur lorsque le verrouillage est activé provoque l'apparition du message suivant.

Les autres fonctions

Affichage de la température ambiante.

- La température est affichée seulement entre 16°F ~ 120°F (-9°C ~ 49°C).
- Une température inférieure à 15°F (-9°C) est indiquée avec LO (BASSE) et une température supérieure à 121°F (49°C) est indiquée avec HI (HAUTE).



Fonction diagnostic (détection de défauts)

- La fonction diagnostic détecte automatiquement tout défaut du produit pendant que le réfrigérateur est en fonctionnement.
- Si votre réfrigérateur ne marche pas bien, ne coupez pas le courant. En tout cas, contactez le service après-vente local agréé ou téléphonez notre service d'assistance technique. Si vous éteignez l'appareil, il sera plus difficile pour le technicien de détecter le problème.

Comment l'eau d'ice/cold est fournie

L'eau est refroidie tandis qu'elle est entreposée dans le réservoir d'eau dans la porte du congélateur, et de là envoyée au distributeur.

La glace est faite dans la machine à glaçon automatique et envoyée au distributeur.

Précautions

Jetez les premiers glaçons (environ 20 pièces) ainsi que l'eau (environ 7 verres) produits tout de suite après la première installation du réfrigérateur.

Ceci est encore nécessaire si le réfrigérateur n'a pas été utilisé pendant une longue période.

Ne laissez pas les enfants s'approcher du distributeur.

Les enfants pourraient jouer avec les commandes ou les abîmer.

Prenez soin à ce que les aliments ne bloquent pas le passage de la glace.

Si les aliments sont rangés sur le passage de glace, le distributeur pourrait marcher mal. Le passage pourrait aussi se bloquer avec de la glace si vous n'utilisez que le mode glace pilée. Enlevez la glace accumulée.

Les boîtes à stockage ou d'autres objets se trouvant au bac à glaçons pourraient abîmer la glacière ou le récipient pourrait crever.

N'employez jamais de verres en cristal mince ou de vaisselle en faïence pour recueillir de la glace.

Ce genre de verres ou récipients pourraient se casser.

Mettez d'abord la glace dans le verre avant de le remplir avec de l'eau ou une autre boisson.

Vous pourriez faire éclabousser de l'eau si vous ajoutez de la glace à un verre d'eau.

Maintenez vos mains et les outils hors de la porte et du passage de glace.

Vous pourriez casser quelque chose ou vous blesser.

N'enlevez jamais le couvercle de la glacière.

De temps en temps, secouez le bac afin de raccommoder la glace.

Les glaçons peuvent parfois s'entasser tout juste autour de la glacière, ce qui ferait entraînerait une lecture incorrecte du niveau du bac et la glacière cesserait de produire de la glace.

Si la glace ou l'eau sortent jaunâtres, contactez immédiatement un centre de service après-vente agréé et n'utilisez pas la glacière jusqu'à ce que le problème soit résolu.

N'employez jamais de verres trop étroits ou profonds.

De la glace pourrait se coincer au passage de glace, ceci pouvant entraîner le mauvais fonctionnement du réfrigérateur.

Maintenez le verre à une distance appropriée de la sortie de glace.

Un verre trop proche de la sortie pourrait faire obstacle à la sortie de glace.

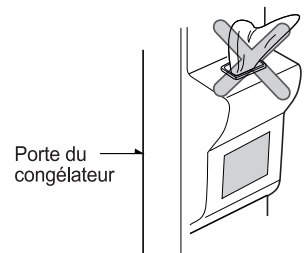

Réglage en hauteur de l'étagère

Étagère

L'étagère du compartiment du réfrigérateur est amovible, vous pouvez donc la placer à la hauteur nécessaire en fonction des aliments à ranger.

- Étagère glissante
Tirez l'étagère en avant et enlevez-la tout en soulevant la partie avant et arrière.

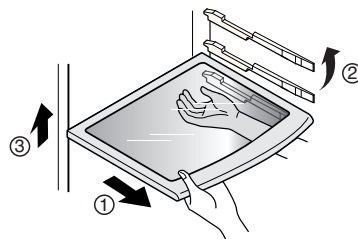

- Étagère fixée, Étagère pliante
- Soulevez légèrement la partie avant de l'étagère vers le haut pour la tirer en avant et puis enlevez-la tout en soulevant la partie arrière de l'étagère.

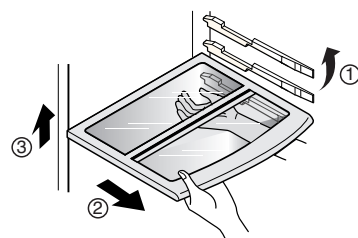

NOTE

- Assurez-vous que l'étagère est horizontale. Autrement, elle pourrait tomber.

Glisser-Sous L'Étagère

Vous pouvez stocker des articles plus grands tels qu'un récipient ou des bouteilles en poussant simplement la moitié avant de l'étagère sous la moitié arrière de celle-ci. Tirez vers vous pour retrouver une étagère entière.

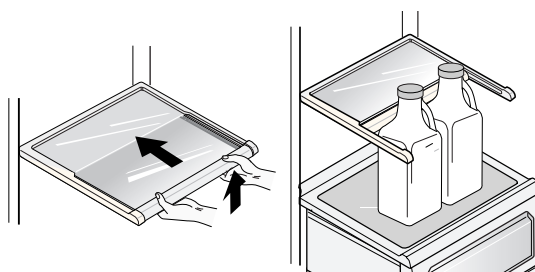

Contrôle de l'humidité dans le bac à légumes

L'humidité peut être contrôlée en réglant l'interrupteur de contrôle d'humidité vers la gauche ou vers la droite lors du stockage de légumes ou fruits.

Haute humidité

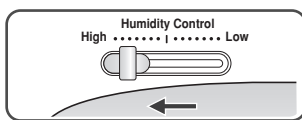

Basse humidité

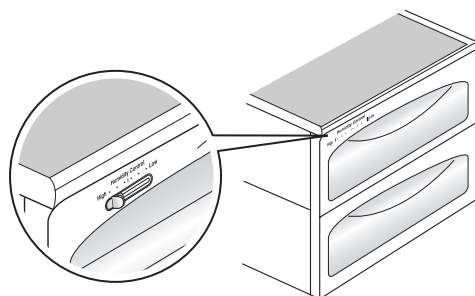
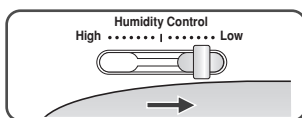

Méthode à employer**Casier à temperature OptiFresh**

Vous pouvez choisir la température optimale pour stocker n'importe quel types de nourritures.

- les légumes, fruits, les articles d'entrepasage au froid exigeant le maintient d'une certaine humidité peuvent être stockés dans une condition optimale en appuyant sur le bouton.

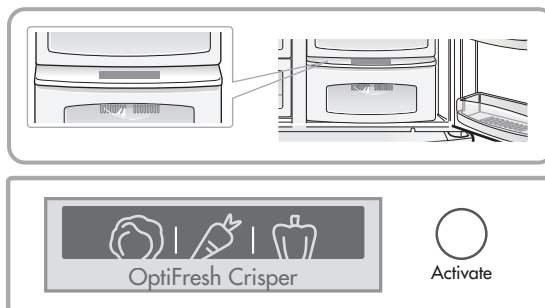
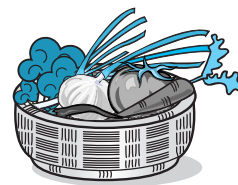

- Si vous ouvrez la porte de réfrigérateur, un voyant montre le statut de l'OptiFresh. La lampe s'éteint quand la porte se referme.
- Appuyez sur le bouton pour faire un cycle à travers ON→OFF→ON.

OptiFresh**Comment enlever OptiFresh**

- D'abord, enlevez le casier à légumes.
- Après s'être tenu en arrière et l'avant de l'OptiFresh ① and ② tirez-le vers l'extérieur.

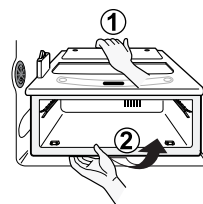
**Comment remettre OptiFresh**

- Placer le casier d'OptiFresh dessus du ① et part le rebord glisser le doucement dedans ② .
- Si vous forcez, les pièces se reliant peuvent être endommagées.

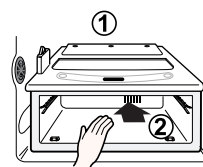

Rangement des aliments

(Voir identification des composants)

Tiroir à casse-croûte

Stockez de petits aliments tels que: du pain, des casse-croûtes, etc.

Étagère du compartiment du congélateur

Stockez divers aliments surgelés tels que: de la viande, du poisson, de la crème glacée, des casse-croûtes surgelés, etc.

Balconnets de la porte du compartiment du congélateur

Stockez de petits aliments surgelés emballés.

Tiroir du compartiment du congélateur

Stockez de la viande, du poisson, du poulet, etc., après les avoir enveloppés d'une mince lame métallique. Stockez à sec.

Balconnet à produits laitiers

Stockez des produits laitiers tels que: du beurre, du fromage, etc.

Bac à rafraîchissements

Stockez les aliments que vous employez fréquemment tels que les boissons, etc.

Étagère du compartiment du réfrigérateur

Stockez les mets d'accompagnement ou d'autres aliments à une distance appropriée.

Balconnets de la porte du compartiment du réfrigérateur

Stockez des petits aliments emballés ou des boissons telles que: du lait, du jus, de la bière, etc.

Bac à légumes

Stockez des légumes ou des fruits.

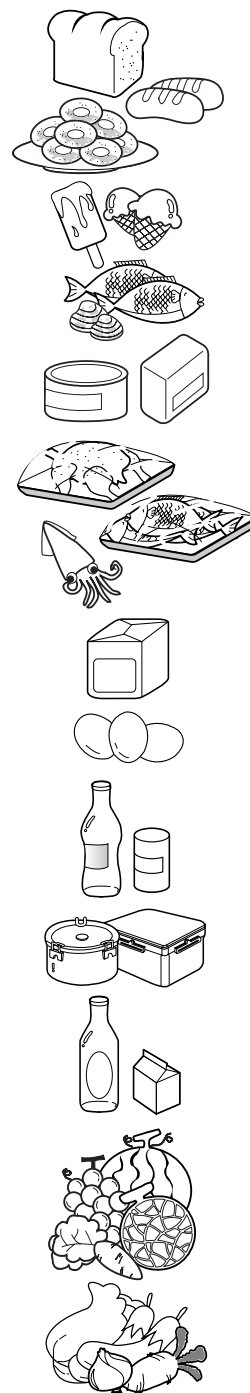

Stockage des aliments

- Stocker des aliments frais dans le compartiment du réfrigérateur. La manière dont les aliments sont congelés et décongelés est un facteur important pour maintenir la fraîcheur et la saveur des produits.
- Ne stockez pas d'aliments facilement périssables à basses températures, tels que les bananes et les melons.
- Laissez refroidir les aliments chauds avant de les stocker, si vous rangez des éléments chauds dans le réfrigérateur ils pourraient abîmer d'autres produits et provoquer une plus grande consommation d'énergie.
- Lorsque vous stocker des aliments, enveloppez-les en vinyle ou placez-les dans des récipients à couvercle. Ceci évite l'évaporation de leur humidité et contribue à maintenir la saveur et les nutriments des aliments.
- Ne bloquez pas les sorties de ventilation d'air avec des aliments. Une correcte circulation de l'air froid maintient la température du réfrigérateur au niveau correct.
- N'ouvrez pas fréquemment la porte. Lorsque vous ouvrez la porte de l'air chaud entre dans le réfrigérateur et la température augmente.
- Ne stockez jamais trop d'aliments dans les balconnets de la porte, car il peuvent appuyer contre les clayettes internes et la porte pourrait ne pas fermer correctement.

Compartiment du congélateur

- Ne conservez pas de bouteilles dans le compartiment congélateur. Elles risquent de se briser en gelant.
 - Ne recongelez jamais des aliments dégelés. Cela provoque une perte de goût et de pouvoir nutritif.
 - Lorsque vous conservez pour une période assez longue des aliments congelés comme de la crème glacée, placez-les sur l'étagère du congélateur et non dans le panier de porte.
 - Ne touchez ni les aliments ni les récipients froids –en particulier ceux faits en métal-, avec les mains humides et ne rangez pas les récipients en verre dans le compartiment du congélateur.
- Autrement, vous pouvez subir des engelures et les récipients en verre peuvent se casser lorsque les substances qu'ils contiennent sont congelées, provoquant des blessures.

Compartiment du réfrigérateur

- Evitez de ranger des aliments humides sur les étagères supérieures du réfrigérateur, ils pourraient être surgelés à cause du contact direct avec l'air froid.
- Nettoyez toujours les aliments avant de les refroidir. Les légumes et les fruits devraient être lavés et séchés, et les aliments emballés devraient être séchés, afin d'éviter que les aliments se trouvant près de ceux-là s'abîment.
- Lorsque vous stockez des oeufs dans le bac à oeufs, assurez-vous qu'ils sont frais, et rangez-les toujours en position verticale afin qu'ils restent frais plus longtemps.

NOTE

- Si le réfrigérateur est dans un endroit chaud et humide, le fait d'ouvrir fréquemment la porte ou de stocker une grande quantité de légumes peut provoquer la condensation, ce qui ne nuit pas à sa performance. Enlevez la condensation avec un chiffon sans aucun élément de nettoyage.

Comment démonter les composants

NOTE

- Le démontage des composants doit s'effectuer à l'inverse de l'assemblage. Assurez-vous de débrancher le câble d'alimentation avant de réaliser le démontage et l'assemblage. N'employez pas trop de force pour démonter les composants. Ils pourraient s'abîmer.

Lampe du compartiment du congélateur

Retirez la lampe en tirant vers le dehors, tout en frappant doucement et en faisant tourner le couvercle de la lampe. Faites tourner l'ampoule dans le sens contraire des aiguilles d'une montre. L'ampoule à employer est de 40W maximum. Vous pouvez l'acheter dans un centre de service après-vente.

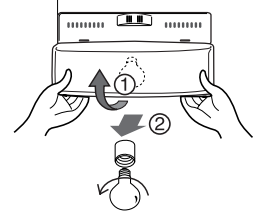

Etagère du compartiment du congélateur

Pour enlever l'étagère, levez un petit peu la partie gauche de l'étagère, poussez dans la direction ①②, levez la partie droite dans la direction ③, et retirez-la.

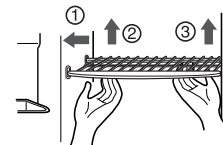

Support et balconnet de la porte

Levez le balconnet de la porte en l'attachant des deux côtés ① et tirez vers le dehors dans la direction ②

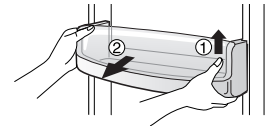

Casier d'entreposage dans la glace

placer le casier d'entreposage dans la glace comme représenté sur la bonne figure et tirez hors de ② tout en soulevant légèrement ①.

- On recommande de ne pas démanteler le casier d'entreposage dans la glace à moins qu'il soit nécessaire.
- Utilisez les deux mains pour enlever le casier de glace pour éviter de le laisser tomber.

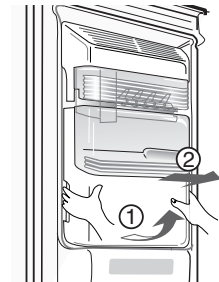

Après l'utilisation du distributeur

Le collecteur d'eau n'a pas de fonction autodrainage. Vous devriez le nettoyer régulièrement. Enlevez le couvercle en tirant de la partie frontale du collecteur d'eau et séchez-le avec un chiffon.

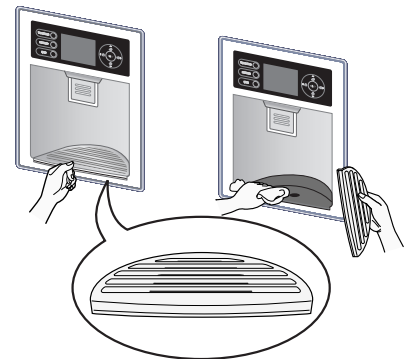

Lampe supérieure en compartiment de réfrigérateur

Pour enlever la protection de la lampe, tirez celle-ci de la lampe à changer tout en poussant le côté inférieur de la protection de lampe vers le haut. Tournez l'ampoule dans le sens contraire des aiguilles d'une montre. Employez une ampoule 40-watt (le maximum.) ce qui peut être acheté dans un centre commercial.

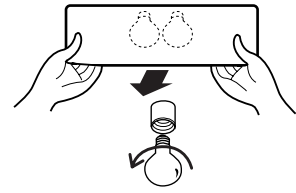

Lampe inférieure dans le compartiment du réfrigérateur

Séparer la protection de la lampe en tenant les deux côtés inférieurs de celle-ci et tirer pour l'enlever. Tournez l'ampoule dans le sens contraire des aiguilles d'une montre. Employez un bulbe (max 40-watt.) ce qui peut être acheté à un centre commercial.

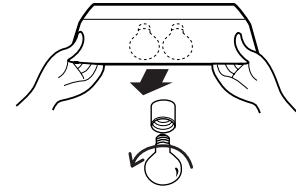

NOTE

- Soyez sûr d'enlever les pièces de la porte de réfrigérateur en enlevant le compartiment, le tiroir de casse-croûte, et la protection des légumes du centre de rafraîchissement.

Couvercle du bac à légumes

- Pour enlever le couvercle du bac à légumes, tirez un petit peu en avant le bac ①, levez la partie frontale du couvercle du bac à légumes comme indiqué sur la figure ②, et retirez-le.

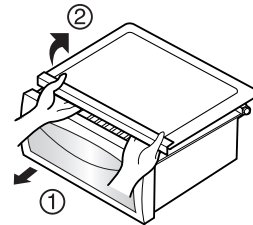

Remplacement Du filtre

Après avoir changé la cartouche du filtre à eau, réglez de nouveau l'affichage de l'état du filtre à eau et le témoin lumineux en appuyant sur **BUTTON** et en le maintenant enfoncé pendant 3 secondes.

- 1) Enlevez la vieille cartouche.
Tournez le bouton de la cartouche dans le sens des aiguilles d'une montre.
Lorsque la cartouche est enlevée, vous apercevrez qu'elle se détache de sa place avec un déclic. Retirez la cartouche.

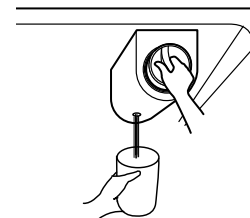
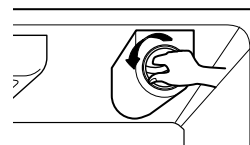

NOTE

- Mettre un godet au-dessous du trou lors du remplacement du filtre, puisque un peu d'eau (25cc) coule pendant ce temps.

- 2) Remplacez avec une nouvelle cartouche.
Retirez la nouvelle cartouche de son emballage et enlevez le matériau de protection des joints ronds. Mettez le bouton de la cartouche en position verticale et introduisez la nouvelle cartouche filtrante en la poussant dans le couvercle jusqu'à ce qu'elle s'arrête.
Si vous ne pouvez pas tourner le filtre d'un côté à l'autre, il n'est pas entièrement inséré.
Poussez-le fermement et vissez-le sur place. Vous entendrez un bruit sec lorsqu'il s'ajuste sur place. En utilisant son poignet, tournez la cartouche dans le sens des aiguilles d'une montre en tour. Vous entendrez un bruit sec lorsqu'elle s'ajuste sur place.

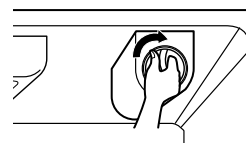
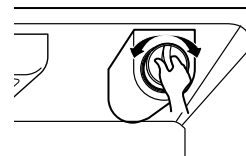

- 3) Lavez à grande eau le système d'eau après avoir remplacé le filtre. Distribuez de l'eau par le distributeur d'eau pendant 3 minutes afin de nettoyer le système.

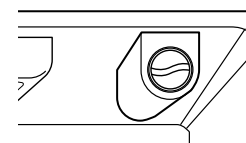

Information générale

Période de vacances

Lors des vacances d'une durée moyenne, il est peut-être mieux de laisser le réfrigérateur en marche. Rangez les produits susceptibles d'être congelés dans le congélateur afin de les faire durer plus longtemps.

Lorsque vous décidez de stocker le réfrigérateur, retirez-en tous les aliments, débranchez le câble d'alimentation, nettoyez bien tout l'intérieur, et laissez les portes ouvertes afin d'empêcher l'apparition de moisissure.

Assurez-vous que le réfrigérateur ne représente pas un danger pour que les enfants y restent enfermés.

Panne d'électricité

La plupart des pannes d'électricité dont la durée est d'une ou deux heures n'ont pas d'effet sur les températures du réfrigérateur.

Cependant, vous devriez réduire au minimum le nombre de fois que la porte est ouverte pendant que le courant est coupé.

Si vous déménagez

Enlevez ou fixez toutes les parties détachées se trouvant à l'intérieur du réfrigérateur. Afin de ne pas endommager les vis de serrage en hauteur, placez-les à la base.

Conduit anticondensation

Le parois externe de la caisse du réfrigérateur peut parfois se réchauffer, en particulier tout juste après son installation.

Ne vous en faites pas. Ceci est provoqué par le conduit anticondensation, qui fait sortir du réfrigérant chaud pour éviter que le parois de la caisse extérieure condense de l'eau.

Nettoyage

Il est important de maintenir votre réfrigérateur propre afin d'éviter de mauvaises odeurs. Les aliments versés devraient être immédiatement séchés, car ils pourraient s'acidifier et colorer les surfaces plastiques s'ils restent trop longtemps.

Extérieur

Utilisez une solution tiède de savon suave ou de détergent pour nettoyer la finition durable de votre réfrigérateur. Nettoyez-le avec un chiffon humide et propre, puis séchez-le.

Intérieur

Nous vous recommandons de réaliser le nettoyage régulièrement. Lavez tous les compartiments avec une solution de bicarbonate de soude ou de l'eau tiède additionnée de détergent. Rincez-le et séchez-le.

Après le nettoyage

Vérifiez que le cordon d'alimentation n'est pas abîmé, que la prise de courant n'est pas réchauffée et que la fiche est bien branchée conformément au consentement d'énergie.

Attention

Débranchez toujours le cordon d'alimentation de la prise de courant murale avant de faire le nettoyage aux alentours des parties électriques (lampes, interrupteurs, commandes, etc.).

Enlevez l'excès d'humidité avec une éponge ou un chiffon afin d'éviter que l'eau ou le liquide atteigne une des parties électrique provoquant ainsi un choc électrique.

N'employez jamais d'éponges à récurer métalliques, de brosses, de nettoyeurs abrasifs gros, d'agents de nettoyage alcalin forts, de liquides à nettoyage inflammables ou toxiques sur aucune surface.

Ne touchez pas aux surfaces surgelées avec les mains humides ou mouillées, car les objets mouillés s'adhèrent ou se collent aux surfaces extrêmement froides.

Dépannage

Avant de faire un appel de service, vérifiez cette liste. Cela peut vous faire économiser du temps et de l'argent.

Cette liste comporte des cas communs qui n'ont pas de rapport avec des travaux ou des matériaux défectueux de cet appareil.

Cas	Cause possible	Solution
Fonctionnement du réfrigérateur		
Le compresseur du réfrigérateur ne marche pas.	La commande du réfrigérateur sur la position off.	Programmez la commande du réfrigérateur. Voir programmation des commandes.
	Le réfrigérateur est au cycle dégivrage.	Ceci est normal pour un réfrigérateur à dégivrage complètement automatique. Ce cycle de dégivrage se met en marche périodiquement.
	La fiche est débranchée de la prise de courant murale.	Assurez-vous que la fiche est bien branchée sur la prise de courant.
	Panne d'électricité. Vérifiez les lumières de la maison.	Téléphonez à votre fournisseur d'énergie.
Le réfrigérateur fonctionne trop ou trop longtemps	Ce réfrigérateur est plu grand que celui que vous aviez précédemment.	Ceci est normal. Une unité plus grande, plus efficace fonctionne plus longtemps dans ces conditions.
	La température ambiante ou extérieure est haute.	Il st normal que le réfrigérateur fonctionne plus longtemps dans ces conditions.
	Le réfrigérateur a été débranché pendant une longue période.	Il faut attendre quelques heures pour que le réfrigérateur cesse de refroidir complètement.
	De grandes quantités d'aliments tièdes ou chauds doivent avoir été stockés récemment.	Les aliments tièdes provoqueront que le réfrigérateur marche plus longtemps jusqu'à ce qu'ils aient atteint la température requise.
	Les portes sont ouvertes très souvent ou pendant une trop longue période de temps.	L'air tiède qui entre dans le réfrigérateur le fait marcher plus longtemps. Ouvrez la porte moins fréquemment.
	La porte du réfrigérateur pourrait être un peu ouverte.	Assurez-vous que le réfrigérateur est au niveau. Vérifiez que les aliments et récipients ne bloquent pas la porte. Voir la section problèmes. OUVERTURE/FERMETURE des portes.
	La commande de contrôle du réfrigérateur est réglée pour une température trop froide.	Réglez la commande de contrôle pour une température plus haute pour que la température du réfrigérateur soit satisfaisante.
	Le joint de la porte du réfrigérateur ou congélateur est sale, usé, cassé ou mal monté.	Nettoyez ou remplacez le joint. Les fuites d'air par le joint de la porte feront marcher plus longtemps le réfrigérateur afin de maintenir les températures requises.
	Le thermostat maintient le réfrigérateur à une température constante.	Ceci est normal. Le réfrigérateur se met en marche et s'arrête pour maintenir la température constante.

Cas	Cause possible	Solution
Le compresseur du réfrigérateur ne marche pas.	Le thermostat maintient le réfrigérateur à une température constante.	Ceci est normal. Le réfrigérateur se met en marche et s'arrête pour maintenir la température constante.

Les températures sont trop basses

La température du congélateur est trop basse mais la température du réfrigérateur est satisfaisante.	La commande de contrôle du congélateur est réglée pour une température trop basse.	Réglez la commande de contrôle pour une température plus haute pour que la température du congélateur soit satisfaisante.
La température du réfrigérateur est trop basse et la température du congélateur est satisfaisante.	La commande de contrôle du réfrigérateur est réglée pour une température trop froide.	Réglez la commande de contrôle du réfrigérateur pour une température plus haute.
Les aliments rangés dans les tiroirs se congèlent.	Les aliments rangés dans les tiroirs se congèlent.	Voir la solution précédente.

Les températures sont trop hautes

Les températures du réfrigérateur ou du congélateur son trop hautes.	La commande de contrôle du congélateur est réglée pour une température trop haute.	Réglez la commande de contrôle pour une température plus basse pour que la température du congélateur soit satisfaisante.
	La commande de contrôle du réfrigérateur est réglée pour une température trop haute. La température réglée pour le réfrigérateur a des effets sur température du congélateur.	Réglez la commande de contrôle du congélateur ou du réfrigérateur pour une température plus basse jusqu'à ce que le congélateur ou le réfrigérateur atteigne une température satisfaisante.
	Les portes sont ouvertes très souvent ou pendant une trop longue période de temps.	De l'air tiède entre dans le réfrigérateur/congélateur quand on ouvre la porte. Ouvrez la porte moins fréquemment.
	La porte est un petit peu ouverte.	Fermez complètement la porte.
	De grandes quantités d'aliments tièdes ou chauds doivent avoir été stockés récemment.	Attendez jusqu'à ce que le réfrigérateur ou congélateur puisse atteindre la température choisie.
	Le réfrigérateur a été débranché pendant une longue période.	Il faut attendre quelques heures pour que le réfrigérateur cesse de refroidir complètement.
La température du réfrigérateur est trop haute mais la température du congélateur est satisfaisante.	La commande de contrôle du réfrigérateur est réglée pour une température trop haute.	Réglez la commande de contrôle du réfrigérateur pour une température plus basse.

Cas	Cause possible	Solution
Son et bruit		
Des bruits plus hauts quand le réfrigérateur est en fonctionnement.	Les réfrigérateurs actuels ont augmenté leur capacité de stockage et ils maintiennent des températures plus stables.	Il est normal que les bruits soient plus hauts.
Des bruits plus hauts quand le compresseur est en fonctionnement.	Le réfrigérateur fonctionne à des pressions plus hautes pendant le démarrage.	Ceci est normal. Le bruit diminuera au fur et à mesure que le réfrigérateur continue à marcher.
Des vibrations ou des bruits.	Le sol est irrégulier ou n'est pas solide. Le réfrigérateur roule dans le sol quand on le déplace doucement.	Assurez-vous que le sol est régulier et solide et qu'il peut bien supporter le poids du réfrigérateur.
	Les objets placés sur la partie supérieure du réfrigérateur vibrent.	Retirez ces objets-là.
	Les assiettes vibrent sur les étagères du réfrigérateur.	Il est normal que les assiettes vibrent doucement. Déplacez-les doucement. Assurez-vous que le réfrigérateur est au niveau et fermement placé sur le sol.
	Le réfrigérateur touche le mur ou les placards.	Déplacez le réfrigérateur pour qu'il ne touche ni le mur ni le réfrigérateur.

Eau/Humidité/Glace à l'intérieur du réfrigérateur

L'humidité s'accumule dans les parois intérieures du réfrigérateur.	Si le climat est chaud et humide, ceci augmente la quantité de glace accumulée et la condensation d'eau à l'intérieur.	Ceci est normal.
	La porte est un petit peu ouverte.	Voir la section problèmes, ouverture/fermeture des portes.
	Les portes sont ouvertes très souvent ou pendant une trop longue période de temps.	Ouvrez la porte moins fréquemment.

Eau/Humidité/Glace à l'extérieur du réfrigérateur

L'humidité apparaît à l'extérieur du réfrigérateur ou entre les portes.	Le climat est humide.	Ceci est normal dans des endroits à climat humide. Lorsque l'humidité ambiante diminue, l'humidité du réfrigérateur devrait elle disparaître.
	La porte est un petit peu ouverte, ce qui permet que l'air froid du réfrigérateur entre en contact avec l'air chaud de l'extérieur.	Fermez complètement la porte.

Cas	Cause possible	Solution
-----	----------------	----------

Des odeurs dans le réfrigérateur

	Il faut nettoyer l'intérieur du réfrigérateur.	Nettoyez l'intérieur à l'aide d'une éponge, de l'eau tiède additionnée de bicarbonate de soude.
	Il y a des aliments qui dégagent une forte odeur à l'intérieur du réfrigérateur.	Couvrez complètement les aliments.
	Quelques récipient et matériaux d'emballage dégagent des odeurs.	Utilisez d'autres récipients ou du matériel d'emballage d'une autre marque.

Ouverture/Fermeture des portes/tiroirs

Les portes ne fermeront pas.	L'emballage des aliments ne permet pas de fermer la porte.	Déplacez tous les emballages qui ne permettent pas de fermer la porte.
Les portes ne fermeront pas.	Une porte a été fermée trop fort, ce qui a provoqué l'ouverture d'une autre.	Fermez avec soin les deux portes.
	Le réfrigérateur n'est pas au niveau. Il roule par le sol quand on le déplace doucement.	Serrez le vis de réglage en hauteur.
	Le sol est irrégulier ou peu solide. Le réfrigérateur roule par le sol quand on le déplace doucement.	Assurez vous que le sol est régulier et qu'il peut supporter bien le poids du réfrigérateur. Contactez le charpentier pour corriger les déformations ou pentes du sol.
	Le réfrigérateur touche le mur ou les placards.	Déplacez le réfrigérateur.
Les tiroirs sont difficiles à déplacer	Un aliment touche à l'étagère dans la partie supérieure du tiroir.	Rangez moins d'aliments dans le tiroir.
	La glissière sur laquelle glisse le tiroir est sale.	Nettoyez le tiroir et la glissière.

Distributeur

Le distributeur ne fournit pas de glace	Le bac à stockage de glaçons est vide.	Lorsque les premiers glaçons tombent dans le bac, le distributeur devrait marcher bien.
	La commande de contrôle du congélateur est réglée pour une température trop haute.	Réglez la commande de contrôle du congélateur pour une température plus basse pour que la glacière commence à produire des glaçons.
	Le robinet de la canalisation d'eau de la maison n'est pas ouvert.	Ouvrez le robinet de la canalisation d'eau de la maison puis attendez suffisamment pour que la glacière produise de la glace.
	La porte du réfrigérateur ou du congélateur n'est pas fermée	Assurez-vous que les deux portes sont fermées.

Cas	Cause possible	Solution
Le distributeur ne fournira pas de la glace.	La glace a fondu et congelé autour du distributeur en raison d'un usage peu fréquent, des variations de la température et/ou des pannes d'électricité.	Enlevez le bac à stockage de glaçons, et dégelez son contenu. Nettoyez le bac, séchez-le et remettez-le à sa place.
Le distributeur est coincé.	Les glaçons sont coincés dans la goulotte de la glacière et dans la partie arrière du bac.	Enlevez les glaçons coincés dans le distributeur.
	Les glaçons sont collés les uns aux autres.	Utilisez fréquemment le distributeur afin d'éviter que les glaçons collent les uns aux autres.
	Les glaçons achetés ou produits d'une autre manière ont été utilisés dans le distributeur.	Vous ne devriez utiliser dans le distributeur que des glaçons produits par la glacière automatique.
Le distributeur ne fournira pas d'eau.	Le robinet de la canalisation d'eau de la maison n'est pas ouvert. Voir problèmes: la glacière ne produit pas de glace.	Ouvrez le robinet de la canalisation d'eau de la maison.
	La porte du réfrigérateur ou du congélateur n'est pas fermée.	Assurez-vous que les deux portes sont fermées.
L'eau a une mauvaise saveur et/ou odeur.	L'eau est restée trop longtemps au réservoir.	Chargez et déchargez 7 verres d'eau afin de nettoyer la conduite. Chargez et déchargez encore 7 verres pour rincer complètement le réservoir.
	L'unité n'est pas correctement raccordée à une conduite d'eau froide.	Raccordez l'unité à la conduite d'eau froide qui fournit de l'eau pour le robinet de la cuisine.
Bruit quand les glaçons tombent	Ce bruit s'entend normalement lorsque les glaçons produits automatiquement tombent dans le bac à stockage de glaçons. L'intensité du bruit pourrait varier en fonction de l'emplacement du réfrigérateur.	
Bruit quand le distributeur fournit de l'eau	Ce bruit s'entend normalement quand la glacière fournit de l'eau après avoir fourni des glaçons produits automatiquement.	
Divers	Veuillez lire toute l'information contenue dans ce manuel concernant la glacière automatique et le distributeur.	
Prévision météo		
La fonction n'est pas opérationnelle	La réception des données météorologiques (prévisions) et leur affichage à l'écran est susceptible de varier en fonction de votre lieu de résidence et de la position du frigidaire. Recherchez votre code postal dans les pages de ce manuel 151 ou rendez-vous à cette adresse www.ambientdevices.com/cat/device/coverage.html	

NUMEROS D'ASSISTANCE CLIENT:<http://www.lgservice.com>

- Pour prouver la couverture de la garantie
Gardez votre reçu de vente afin de prouver la date d'achat.
Vous devrez fournir une copie de votre reçu de vente lors de la réception d'un service en garantie.
- Pour obtenir de l'assistance concernant le produit, de l'assistance client ou service technique
Téléphonez au numéro gratuit du Service Client.
Tél : 1-800-243-0000
- Pour obtenir l'assistance du centre de service après-vente agréé le plus proche, téléphonez au 1-800-243-0000, choisissez l'option #1, 24 heures sur 24 heures, les 7 jours de la semaine.
Repérez en avance l'information concernant le type de produit (Moniteur, TV, VCR, MWO, Réfrigérateur) ainsi que le code postal.

LG ELECTRONICS, INC. GARANTIE LIMITÉE DU RÉFRIGÉRATEUR



Votre réfrigérateur LG sera réparé ou remplacé, au choix de LG, s'il s'avère défectueux à cause d'un défaut de matériel ou de main d'oeuvre, lors d'une utilisation normale au cours de la période de garantie ("Période de garantie") établie ci-dessous dorénavant, effective à partir de la date d'achat ("Date d'achat") du produit par le client original. Cette garantie n'est valable que pour l'acheteur original du produit et elle n'est effective qu'aux États-Unis, y inclus l'Alaska, le Hawaii et les autres territoires des États-Unis.

<p>PÉRIODE DE GARANTIE: RÉFRIGÉRATEUR/CONGÉLATEUR</p> <p>MAIN D'OEUVRE: Un an à partir de la date d'achat.</p> <p>PIÈCES: Un an à partir de la date d'achat.</p> <p>SYSTÈME SCELLÉ (Compresseur, condenseur et évaporateur)</p> <p>MAIN D'OEUVRE: Un an à partir de la date d'achat.</p> <p>PIÈCES: Sept ans à partir de la date d'achat.</p> <p>Les pièces de rechange ou réparées sont garanties pour la période de temps restant sur la période de garantie originale de l'unité.</p>	<p>COMMENT LE SERVICE TECHNIQUE EST-IL OFFERT:</p> <p>Service technique à la maison (Sauf pour le modèle GR051): Veuillez conserver la facture datée par le revendeur ou bien le bon de livraison comme preuve de la date d'achat pour vous prévaloir de la garantie, et donnez une copie de la facture au technicien à chaque fois qu'un service en garantie vous est offert.</p> <p>Veuillez téléphoner au 1-800-243-0000 et choisissez l'option appropriée pour localiser le centre de service technique agréé LG le plus proche. (Service téléphonique 24 heures sur 24, 365 jours par année.)</p> <p>Ou visitez notre site web à: http://www.lgservice.com</p>
---	---

CETTE GARANTIE EST ACCORDÉE EN REMPLACEMENT DE TOUTE AUTRE GARANTIE, EXPLICITE OU IMPLICITE, Y INCLUS MAIS SANS S'Y LIMITER, TOUTE GARANTIE DE COMMERCIALITÉ OU D'APTITUDE PHYSIQUE POUR UN BUT PARTICULIER. DANS LA MESURE OÙ UNE GARANTIE IMPLICITE EST REQUISE PAR LA LOI, ELLE EST LIMITEE À LA DURÉE DE LA GARANTIE EXPRESSE CI-DESSUS INDIQUÉE. NI LE FABRICANT NI SON DISTRIBUTEUR AUX ÉTATS-UNIS NE SERONT RESPONSABLES POUR AUCUN TYPE DE DOMMAGE ACCESSOIRE, INDIRECT OU IMMATÉRIEL, SPÉCIAL OU DES DOMMAGES-INTÉRÊTS PUNITIFS, Y COMPRIS, MAIS SANS S'Y LIMITER, LES REVENUS OU PROFITS PERDUS OU TOUT AUTRE DOMMAGE SE RAPPORTANT AU CONTRAT, À UN PRÉJUDICE OU TOUT AUTRE. Certaines états ne permettent pas des exclusions ou des limitations concernant les dommages accessoires ou immatériels ou des limitations sur la durée de la garantie implicite. Il est donc possible que ces limitations ou exclusions ne s'appliquent pas à votre cas. Cette garantie vous accorde des droits légaux spécifiques et il est possible que vous ayez d'autres droits, lesquels varient d'un état à l'autre.

La réception des informations sur les prévisions météorologiques reçues et affichées à l'écran est sujette à des modifications en fonction de votre région et de l'emplacement du réfrigérateur. De ce fait, LG ne garantit pas et ne sera pas tenu responsable de l'exactitude de l'information météorologique. Les informations sur les prévisions météorologiques ne sont disponibles qu'aux États-Unis.

CETTE GARANTIE LIMITÉE NE S'APPLIQUE PAS:

- aux déplacements du service technique vers votre maison pour livrer, retirer et/ou installer le produit, pour vous instruire, pour remplacer les fusibles de la maison ou effectuer un câblage correct ou pour la correction de réparations non autorisées;
- aux dommages ou aux problèmes de fonctionnement résultant d'une mauvaise utilisation, d'un emploi abusif, de la mise en marche de l'unité en dehors des spécifications d'ambiance ou dans des conditions contraires aux conditions requises ou aux précautions indiquées dans le Mode d'Emploi, d'un accident, de la vermine, d'un incendie, d'une inondation, d'une installation incorrecte, des cas de force majeure, d'une modification ou altération non autorisée, d'un courant électrique ou tension incorrects, d'une utilisation commerciale ou de tout usage différent de celui pour lequel l'unité a été conçue;
- aux réparations effectuées lorsque votre réfrigérateur LG subi une utilisation autre que l'utilisation normale par un ménage unifamilial.

Les coûts des réparations ou des remplacements sous ces circonstances exclues seront supportés par le consommateur.

NUMÉROS DU CENTRE DE SERVICE APRÈS-VENTE INTERACTIF

<p>Pour obtenir de l'assistance à la clientèle, de l'information sur le produit ou localiser un revendeur ou un centre de service après-vente agréé:</p>	<p>Téléphonez au 1-800-243-0000 (24 heures sur 24, 365 jours par an) et sélectionnez l'option appropriée dans le menu.</p> <p>Ou visitez notre site web à: http://www.lgservice.com</p>
---	--

POUR COMMUNIQUER AVEC LG ELECTRONICS PAR COURRIER:

LG Customer Interactive Center
P. O. Box 240007
201 James Record Road
Huntsville, Alabama 35824
ATTN: CIC

Índice

Introducción	Registro	103
	Indicaciones sobre seguridad importantes	103
	Identificación de las piezas	104
Instalación	Suelo nivelado y resistente	105
	Desinstalación de las puertas	106
	Instale las puertas de los compartimentos del congelador y del refrigerador	107
	Previo a la instalación	107
	Instrucciones de conexión a un suministro de agua	108
	Instrucciones de uso	110
	Ajuste de altura	111
	Conexión de equipos externos	112
Funcionamiento	Inicio	113
	Ajuste de las temperaturas y las funciones	113
	Temperatura	114
	Dispensador	115
	Menu	116
	Bandeja	137
	Control de la humedad en el compartimento de verdura	137
	Temperatura del compartimento OptiFresh	138
	OptiFresh	138
Sugerencias sobre el almacenamiento de los alimentos	Colocación de los alimentos	139
	Almacenamiento de los alimentos	140
Cuidado y mantenimiento	Desinstalación de las piezas	141
	Información general	144
	Limpieza	144
	Solución de problemas	145
	Garantía limitada	150
	Código postal	151

Registro

Los números del modelo y de serie se encuentran en el compartimento interior o en la parte posterior del compartimento refrigerador. Estos números son exclusivos de esta unidad y no corresponden a otras unidades. Es conveniente incluir aquí dicha información y guardar este manual como registro permanente de la compra. Grape aquí la factura.

Fecha de compra : _____
 Distribuidor : _____
 Dirección del distribuidor : _____
 Teléfono del distribuidor : _____
 N° de modelo : _____
 N° de serie : _____

Indicaciones sobre seguridad importantes

Antes de utilizarlo, el refrigerador debe instalarse y ubicarse correctamente siguiendo las instrucciones de instalación de este manual.

No desenchufe el refrigerador tirando del cable de alimentación. Sujete el enchufe con fuerza y tire de él hacia fuera de la toma de corriente.

Al retirar el electrodoméstico de la pared, asegúrese de que éste no pasa por encima del cable de alimentación o de que lo dañe. No oprima el conducto del agua.

Una vez que el refrigerador esté en funcionamiento, no toque las superficies frías del compartimento congelador, especialmente con las manos mojadas o húmedas. La piel podría adherirse a las superficies muy frías.

Desenchufe el cable de alimentación de la toma de corriente para la limpieza u otros requerimientos. Nunca lo toque con las manos mojadas, ya que podría sufrir una descarga eléctrica y resultar herido.

No dañe, doble, enrolle, retuerza ni tire del cable de alimentación, ya que cualquier daño en el cable de alimentación podría causar el funcionamiento incorrecto del producto, un incendio o descargas eléctricas. Si no está seguro sobre si el electrodoméstico está conectado a tierra correctamente, consulte a un electricista calificado por LG Electronics.

No introduzca objetos de cristal en el congelador, ya que podrían romperse como resultado de la expansión al congelarse su contenido.

No introduzca las manos en el compartimento de hielo del suministrador de hielo automático. Podría lesionarse como resultado del funcionamiento del mismo.

El electrodoméstico no está diseñado para que lo utilicen niños sin vigilar.

Debe asegurarse de que los niños no jueguen con el electrodoméstico.

No permita que nadie se suba, se siente, se ponga de pie o se cuelgue de la puerta central para refrescos

Antes de colocar el refrigerador en su ubicación definitiva, asegúrese de que cuenta con la conexión eléctrica adecuada.

Es necesario un suministro eléctrico de 115 V, 60 Hz, CA sólo 15 o 20 Amp con fusible, con toma de tierra. Se recomienda utilizar un circuito independiente para el refrigerador. Utilice una toma de corriente que no se pueda desconectar. No utilice extensiones.

El refrigerador debe situarse de manera que se pueda acceder fácilmente a la toma de corriente para desconectarlo en una emergencia.

Si el cable de alimentación resulta dañado, debe sustituirlo el fabricante, el representante del servicio técnico u otro tipo de personal calificado por LG Electronics con el fin de evitar riesgos.

No modifique ni prolongue el largo del cable de alimentación.

- Esto podría provocar una descarga eléctrica o un incendio.

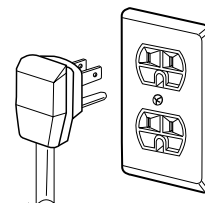

Método recomendado de conexión a tierra.

Acceso a la toma de corriente

Sustitución del cable de alimentación

 **Advertencia**

**Peligro de encierro
Advertencia**

PELIGRO: Riesgo de que los niños se queden encerrados.

Antes de deshacerse de su antiguo refrigerador o congelador:

Quite las puertas pero mantenga las bandejas en su sitio, de manera que los niños no se puedan meter fácilmente.

El electrodoméstico no está diseñado para que lo utilicen niños sin vigilar

Debe asegurarse de que los niños no jueguen con el electrodoméstico.

No guarde

No guarde ni utilice gasolina ni otros líquidos o vapores inflamables cerca de ningún electrodoméstico.

Conexión a tierra

En caso de que se produzca un cortocircuito eléctrico, la conexión a tierra reduce el riesgo de descargas eléctricas proporcionando una vía de escape para la corriente eléctrica.

Para prevenir posibles descargas eléctricas, debe conectarse a tierra este dispositivo.

El uso incorrecto de la conexión a tierra puede tener como resultado una descarga eléctrica. Si no entiende bien las instrucciones de conexión a tierra o tiene dudas sobre si la toma de tierra está bien conectada, consulte a un electricista cualificado o a un miembro del servicio técnico.

Identificación de las piezas

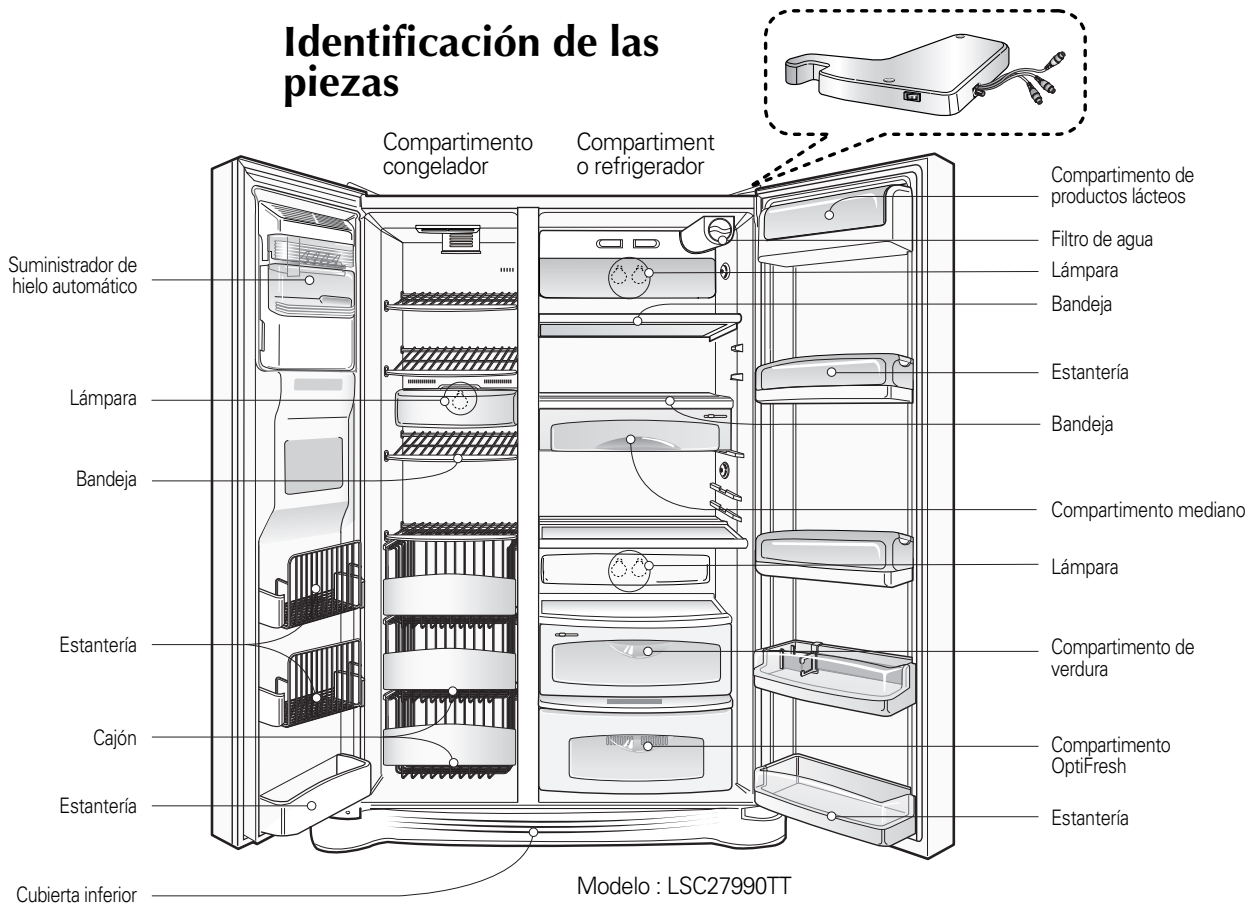

Modelo : LSC27990TT

NOTA

- Las piezas, funciones y opciones de la unidad varían según el modelo. Su modelo puede no incluir todas las opciones.

Suelo nivelado y resistente

Ubicación de la instalación

Una instalación inestable puede ser causa de vibraciones y ruidos. Si el suelo sobre el que piensa instalar el refrigerador fuera inestable, nivele la unidad girando el tornillo de ajuste de altura. La moqueta o el revestimiento del suelo sobre el que instale la unidad puede decolorarse debido al calor procedente de la parte inferior del refrigerador. De ser así, instale una tela gruesa bajo el refrigerador, si fuera necesario.

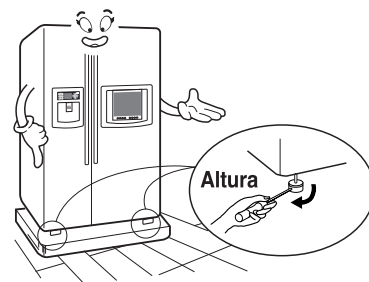

A una distancia adecuada adecuada de cercanos

Por favor, mantenga el refrigerador a una distancia prudente de otros objetos. Una distancia demasiado reducida entre la unidad y los elementos cercanos podría conllevar una reducción de la capacidad de congelación y un aumento del consumo de electricidad.



Donde pueda conectar fácilmente el suministro de agua, en un lugar seco

Seleccione un lugar donde pueda conectar fácilmente el suministro de agua entre la máquina automática de hielo y el dispensador. La instalación del refrigerador en un lugar húmedo podría ser causa de oxidación y representar un riesgo eléctrico.

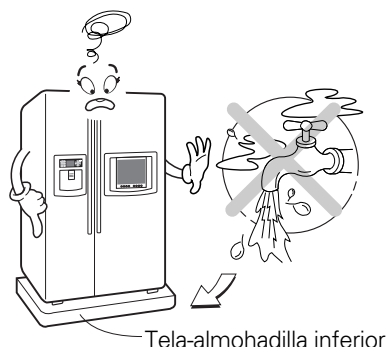

Lejos de Fuentes de calor o gas de carbón

En lugares con altas temperaturas, la capacidad de congelación puede verse deteriorada, al mismo tiempo que aumenta la carga eléctrica. El gas de carbón y el humo pueden decolorar el aspecto exterior de la unidad.

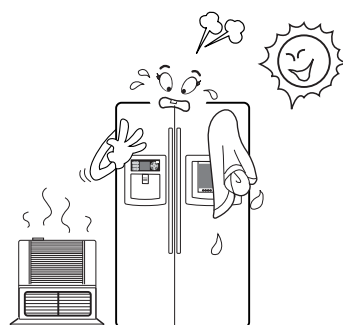

NOTA

- Instale el refrigerador en un lugar donde la temperatura ambiente se encuentre entre 5°C ~ 43°C (41°F~110°F). Las temperaturas fuera de este rango podrían ser causa de averías en el producto. Además, el tubo entre el dispensador y la máquina automática de hielo podría congelarse.

Desinstalación de las puertas

Advertencia

Peligro de descarga eléctrica

Desconecte la alimentación eléctrica del refrigerador antes de la instalación. De lo contrario, puede producirle la muerte o daños graves.

Si la puerta de acceso es demasiado estrecha para introducir la unidad, desinstale las puertas e introdúzcala de lado.

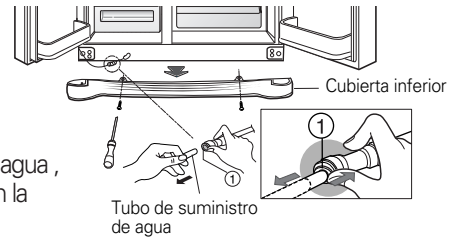

Retire la cubierta inferior y el tubo de suministro de agua

Jale hacia arriba de la cubierta inferior para retirarla y, a continuación, jale hacia arriba del tubo de suministro de agua, mientras mantiene presionada la zona ① que aparece en la figura de la derecha.

NOTA

- Si alguno de los extremos del tubo está deformado o desgastado, córtelo.

Desinstalación de la puerta del compartimento congelador

- 1) Retire la cubierta de la bisagra aflojando los tornillos. Desenchufe todas las conexiones excepto la línea a tierra.

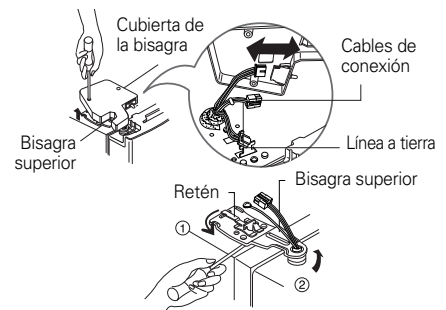

- 2) Retire el retén girándolo en sentido contrario a las agujas del reloj ① y levantando la bisagra superior.

NOTA

- Al retirar la bisagra superior, tenga cuidado para que la puerta no se caiga hacia delante.

- 3) Retire la puerta del compartimento congelador levantándola hacia arriba. Debe tirar de la puerta hacia arriba hasta que el tubo de suministro de agua salga completamente.



NOTA

- Una vez desinstalada la puerta, colóquela en la cocina donde se vaya a instalar el refrigerador. Recárguela sobre una manta y tenga cuidado de no dañar el tubo de suministro de agua.

Desinstalación de la puerta del compartimento refrigerador

- 1) Afloje los tornillos de la cubierta de la bisagra y retire la cubierta y los cables de conexión, en caso de que haya alguno, excepto la línea a tierra.

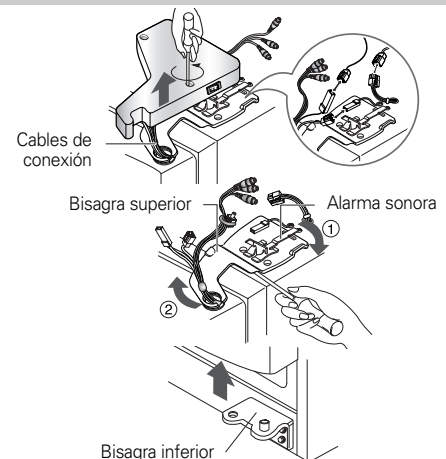

- 2) Retire el retén haciéndolo girar en el sentido de las agujas del reloj ① y, a continuación, retire la bisagra superior levantándola ②.

- 3) Retire la puerta del compartimento refrigerador levantándola.

Desplazamiento del refrigerador

Pase el refrigerador lateralmente a través de la puerta de acceso, como muestra la figura derecha.

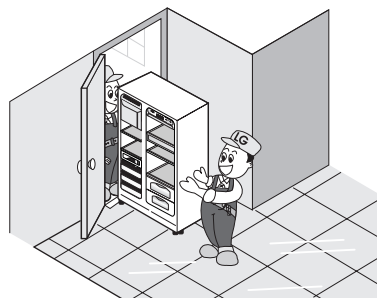

Instale las puertas de los compartimentos del congelador y del refrigerador

Instale las puertas en orden inverso al de su desensamble, y una vez que hayan pasado a través de la puerta de acceso.

Previo a la instalación

Instalación del suministro de agua

- El funcionamiento de la máquina automática de hielo requiere una presión hidráulica de 21~121 psi (1,5~8,5 Kgf/cm²) (Es decir, un vaso de papel (180 cc) se llenaría rápidamente en 3 segundos).
- Si la presión hidráulica no alcanzara los 21 psi (1,5 Kgf/cm²), será necesario adquirir una bomba de presión independiente para lograr una proceso normal de producción de hielo y dispensación de agua fría.
- Mantenga la longitud total del conducto de suministro de agua inferior o igual a 26' (8 m), y tenga cuidado de no doblarlo. Si el conducto tuviera 26' (8 m) o más, podría ser causa de problemas en el suministro de agua debido a la presión hidráulica de drenaje.
- Instale el conducto de suministro de agua en una ubicación lejos de las fuentes de calor.

Advertencia

- Conectar únicamente a una fuente de agua potable.

Eliminación del equipo anterior

Este electrodoméstico contiene fluidos (refrigerante, lubricante) y está compuesto de piezas y materiales reutilizables o reciclables. Todos los materiales importantes deben ser enviados al centro de acopio de residuos, a fin de poder ser reutilizados (reciclados). Por favor, póngase en contacto con su agencia local para obtener más información sobre el proceso de reciclado.

Instrucciones de conexión a un suministro de agua

Lea todas las instrucciones detenidamente antes de comenzar.

Conecte el refrigerador a una fuente de suministro de agua

 **Advertencia**

Utilice únicamente un suministro de agua potable.

IMPORTANTE

- Si ya está utilizando el refrigerador antes de instalar el suministro de agua, coloque el suministrador de hielo en la posición **OFF (DESACTIVADO)** para evitar que funcione sin agua.
- Todas las instalaciones deben realizarse siguiendo la normativa local sobre tuberías.
- Utilice material de cobre y compruebe que no haya fugas.
- Instale únicamente material de cobre en las zonas en las que la temperatura esté por encima de 0 °C.
- Es posible que el suministrador de hielo tarde 24 horas en comenzar a producir hielo.

Herramientas necesarias

- Destornillador estándar
- Llaves de tuercas de 1,1 cm y 1,27 cm o dos llaves inglesas
- Destornillador para tuercas de 0,6 cm
- Broca para taladro de 0,6 cm
- Taladro manual o eléctrico (conectado a tierra)

NOTA

- El distribuidor del refrigerador tiene disponible un kit formado por una válvula de seccionamiento lateral de 0,6 cm, una pieza de empalme y un tubo de cobre. Antes de adquirirla, compruebe que una válvula de seccionamiento lateral cumple con la normativa de tubería local. No utilice una válvula de perforación lateral de 0,4 cm, ya que reduce el flujo de agua y se bloquea con mayor facilidad.

Suministro de agua fría

La válvula de agua del suministrador de hielo contiene una arandela que regula la presión del agua.

El suministrador de hielo debe conectarse a un suministro de agua fría con una presión de 20~120 LPPC (40,6 cm²)

Conexión del tubo al suministro de agua

1. Desenchufe el refrigerador o desconecte la alimentación.
2. Cierre el suministro de agua principal. Abra el grifo más cercana para reducir la presión de la tubería. Puede resultar útil abrir una llave de agua exterior para que salga el agua del sistema de tuberías de la vivienda.
3. Localice una tubería de agua fría vertical de entre 0,6 cm y 1,2 cm cerca del refrigerador.

NOTA

- También se puede utilizar una tubería horizontal, pero debe tomarse esta precaución: Perfore la parte superior de la tubería, no la inferior. De esta forma, el agua se mantendrá alejada de la perforación. Esto también ayuda a que los sedimentos normales no se acumulen en la válvula.

4. Para determinar la longitud del tubo de cobre necesaria, mida la distancia entre la tubería de agua y el conducto situado en la parte inferior izquierda trasera del refrigerador. Añada 2.1 m más con el fin de poder mover el refrigerador para limpiarlo. Utilice un tubo de cobre de 0,6 cm de diámetro exterior. Asegúrese de que los extremos del tubo de cobre están cortados en ángulo recto.
5. Con un taladro, realice una perforación de 0,6 cm en la tubería de agua fría seleccionada.
6. Sujete la válvula de seccionamiento a la tubería de agua fría con una abrazadera. Compruebe que el extremo del tubo está introducido firmemente en la perforación de 0,6 cm de la tubería de agua y que la arandela se encuentra bajo la abrazadera. Apriete la tuerca de compactación. Apriete los tornillos de la abrazadera con cuidado y uniformemente, de manera que la arandela constituya un sello impermeable. No apriete excesivamente los tornillos, ya que de lo contrario podría aplastar el tubo de cobre, especialmente si utiliza un tubo de cobre blando (enrollado). Ya se puede conectar el tubo de cobre.
7. Deslice el manguito y la tuerca de compresión en el tubo de cobre como se muestra. Introduzca el extremo del tubo en el extremo de desagüe hasta donde sea posible. Apriete la tuerca de compresión en el extremo con una llave de tuercas. No apriete demasiado.
8. Coloque el extremo libre del tubo en un recipiente o en un fregadero, conecte el suministro de agua principal y purgue el tubo hasta que el agua sea clara. Cierre la válvula de seccionamiento de la tubería de agua. Enrolle el tubo de cobre como se muestra a continuación.

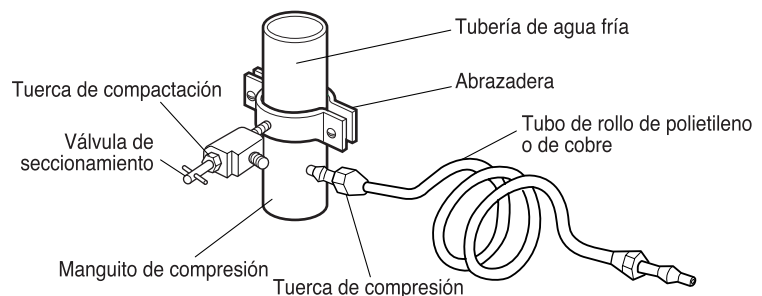

Instrucciones de uso

Conecte el tubo al refrigerador

Antes de realizar la conexión al refrigerador, asegúrese de que el cable de alimentación del refrigerador no está enchufado a la toma de corriente de la pared.

- Si el refrigerador no tiene un filtro de agua, se recomienda que instale uno. Si el suministro de agua arrastra arena u otro tipo de partículas que pueden bloquear el filtro de la válvula de agua del refrigerador. Instale el filtro en la tubería de agua cercana al refrigerador.

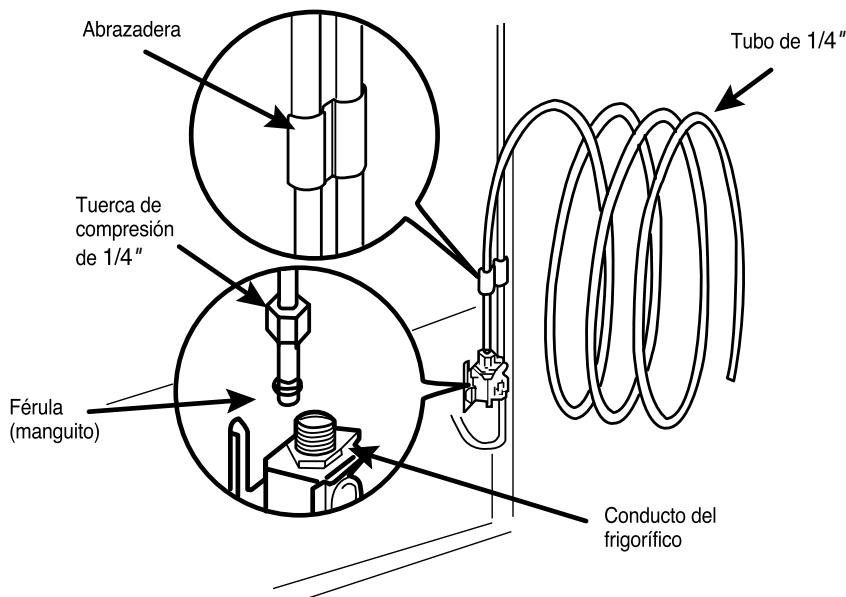

1. Retire la cubierta de plástico flexible de la válvula de agua.
2. Coloque la tuerca de compresión y la férula (manguito) en el extremo del tubo como se muestra.
3. Introduzca el extremo del tubo de cobre en el conducto hasta donde sea posible. Apriete la abrazadera mientras sujeta el tubo.

Abra la válvula de seccionamiento

Apriete cualquier empalme que presente fugas.

■ Enchufe el refrigerador

Coloque el rollo de tubo de cobre en la parte trasera del refrigerador de manera que no vibre contra éste ni contra la pared. Empuje el refrigerador hacia la pared.

■ Conecte el suministrador de hielo

Lleve el interruptor del suministrador de hielo a la posición ON (ACTIVADO). El suministrador no empezará a funcionar hasta que alcance la temperatura de funcionamiento de -9 °C. Entonces, comenzará a funcionar automáticamente.

Ajuste de altura

Si la puerta del compartimento del congelador es inferior a la puerta del compartimento del refrigerador

Nivélelas insertando un destornillador de cabeza plana (tipo -) en la ranura del tornillo de ajuste de altura izquierdo, y gírelo hacia la derecha (⌚).

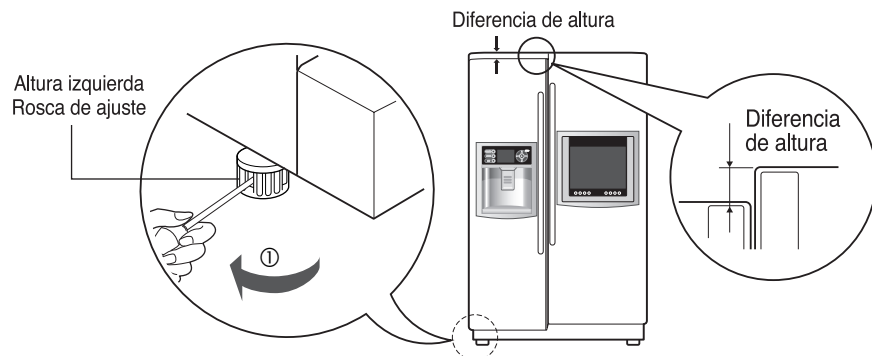

Si la puerta del compartimento del congelador es superior a la puerta del compartimento del refrigerador

Nivélelas insertando un destornillador de cabeza plana (tipo -) en la ranura del tornillo de ajuste de altura derecho, y gírelo hacia la derecha (⌚).

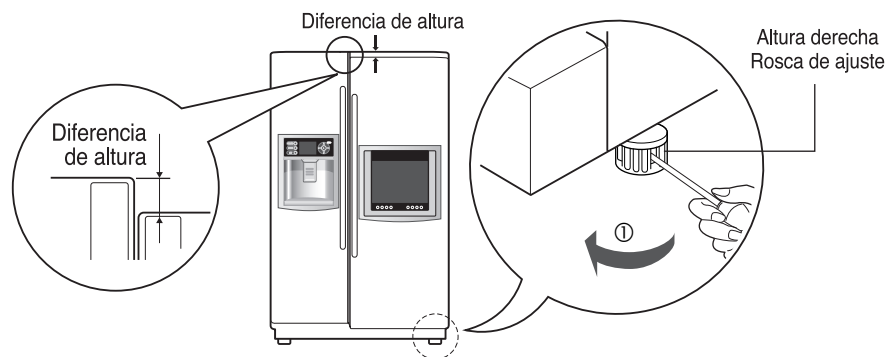

Una vez nivelada la altura de la puerta

La puerta del refrigerador se cerrará con suavidad elevando la parte frontal y ajustando el tornillo de ajuste de la altura.

Conexión de equipos externos

Tomas de entrada de Antena/Cable

- Tenga cuidado de no doblar el cable al conectar a la entrada de antena.

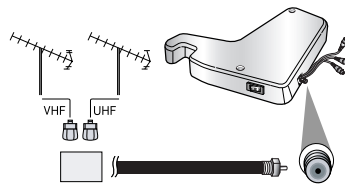
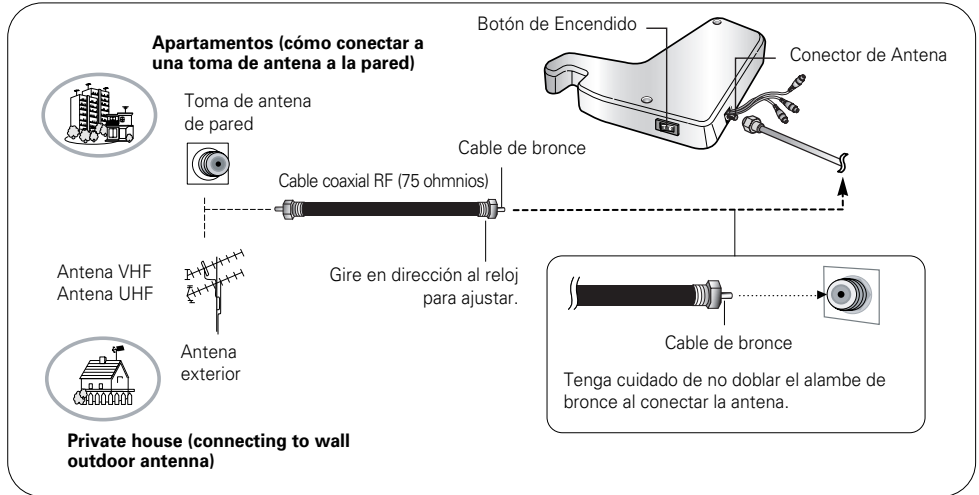

- En un área pobre de la señal para mejorar calidad del cuadro, compre e instale el amplificador de la señal del al.
- Si la antena no está instalada correctamente, entre en contacto con su distribuidor para la ayuda.

Tomas de entrada de VCR / DVD

Cómo realizar la conexión

1. Conecte las tomas de salida de audio/vídeo del vídeo a las tomas de entrada de audio/vídeo del aparato.
2. Pulse el botón **TV/AV/RADIO** para seleccionar **AV**.
3. Pulse el botón **PLAY** en el vídeo. Aparecerá en la pantalla la imagen de reproducción del vídeo.

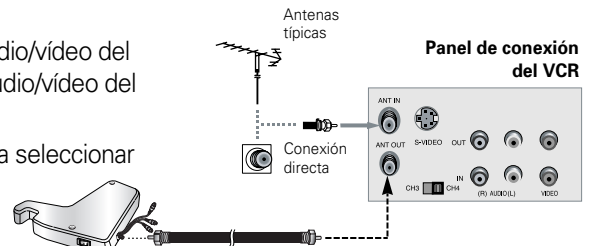

Nota

- Si dispone de un VCR mono, conecte el cable audio del VCR a la entrada **AUDIO L/MONO** situada del televisor.

Tomas de entrada de Cable TV

- Después de haberse suscrito a un servicio de televisión por cable a través de un proveedor local y de haber instalado un adaptador, ya puede usted ver la programación de la televisión por cable.
- Para más información acerca del servicio de televisión por cable, póngase en contacto con su proveedor o proveedores locales de televisión por cable.

Cómo realizar la conexión

1. Pulse el botón de **TV/AV/RADIO** del control remoto y seleccione **TV**.
2. Sintonice los canales que le suministre el servicio de cable utilizando la caja del adaptador de cable.

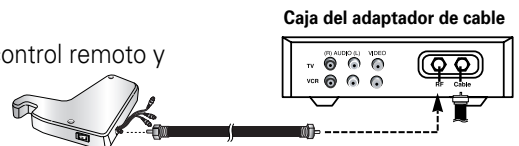

Inicio

Cuando se instala el refrigerador por primera vez, permita que se establezca a las temperaturas de funcionamiento normales durante 2 o 3 horas antes de introducir alimentos frescos o congelados. Si se interrumpe el funcionamiento, espere 5 minutos antes de volver a conectarlo.

Ajuste de las temperaturas y las funciones



Acerca de píxeles defectuosos

Esta pantalla LCD contiene cientos de miles de píxeles individuales. Por lo general, la LCD contiene un pequeño número de píxeles que no funcionan con normalidad. Su pantalla ha sido inspeccionada y cumple correctamente las especificaciones del fabricante, indicando que cualquier píxel defectuoso no afectará al funcionamiento o al uso de su pantalla.

En una pantalla de este tamaño, la presencia de 4 o menos píxeles defectuosos se considera normal, y no es motivo para intercambiar la unidad o recibir una devolución.

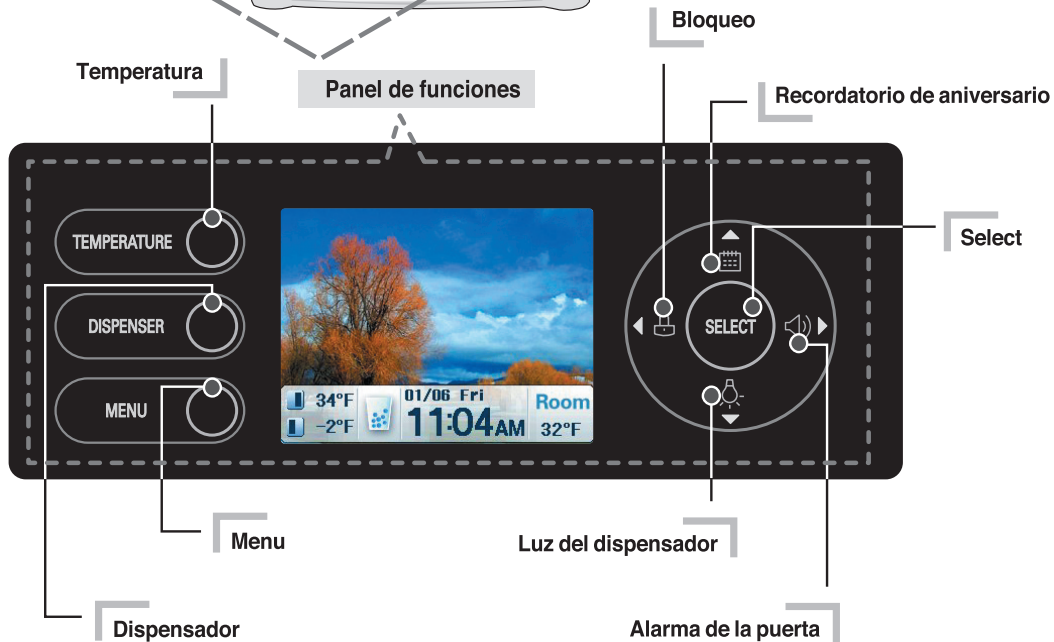

NOTA

- Su modelo puede no incluir todas las opciones.

**Refrigerador/
Congelador**

Temperatura

- Puede ajustar la temperatura del refrigerador y el congelador.

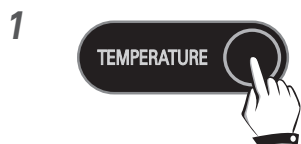

Presione el botón **TEMPERATURE**.

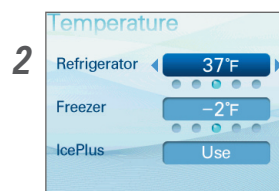

Seleccione el refrigerador deseado utilizando el botón ▲ o ▼.

3 Seleccione la temperatura utilizando el botón ◀ o ▶.

Opciones de temperatura del refrigerador: 46, 41, 37, 34, o 32°F

Opciones de temperatura del congelador: 7, 1, -2, -5, o -8°F

4 Presione el botón **SELECT**.

5 Volver a la pantalla de espera.

Más hielo

- Congelación rápida.

- La pantalla de espera aparece durante el funcionamiento de la función Más hielo .

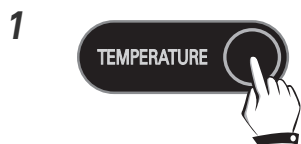

Presione el botón **TEMPERATURE**.

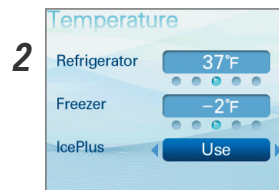

Pulse el botón ▲ o ▼ para seleccionar **IcePlus**.

3 Pulse el botón ◀ o ▶ para seleccionar **Use**.

[Use] <--> [Not in Use]

4 Presione el botón **SELECT**.





6 Volver a la pantalla de espera.

- La temperatura indicada no es la temperatura actual dentro del refrigerador, sino la temperatura objetivo. La temperatura interna actual podría variar, especialmente si la puerta está abierta y recientemente ha guardado en el refrigerador alimentos aún calientes.

- Inicialmente la refrigeración será débil. Ajuste la temperatura como se ha mencionado, tras utilizar el refrigerador durante al menos 2 ó 3 días.

Dispensador

Picado/Agua/ Cubitos

- Podrá seleccionar entre las opciones de hielo picado, agua o cubitos.
- Cuando el dispensador se encuentre en uso, la opción activa estará indicada en la pantalla en espera.
- Picado  , Agua  , Cubitos .



Presione el botón **DISPENSER**.

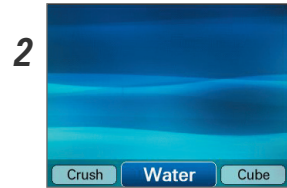

Seleccione la opción deseada utilizando los botones ◀ & ▶.

[Crush] <--> [Water] <--> [Cube]



5 Volver a la pantalla de espera.

Suministrador de hielo automático

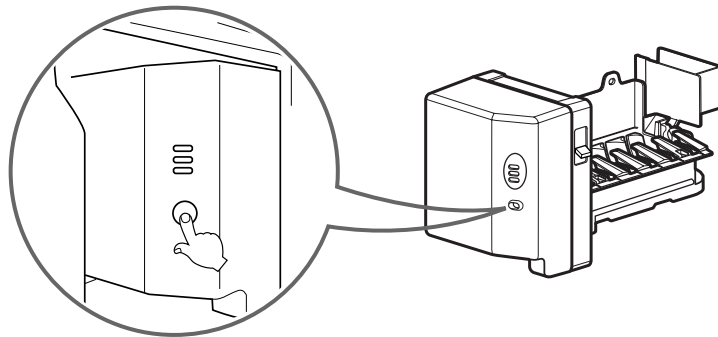

- El suministrador de hielo automático puede producir 8 cubitos a la vez, aproximadamente entre 70 y 120 unidades al día. Esta cantidad puede variar debido a factores como la temperatura ambiente, la apertura de la puerta, la carga del congelador, etc.
- La producción de hielo se detiene cuando el recipiente del hielo está lleno.
- Si no desea utilizar el suministrador de hielo automático, coloque el interruptor en la posición OFF (DESACTIVADO).
Si desea volver a utilizar el suministrador de hielo automático, coloque el interruptor en la posición ON (ACTIVADO).

NOTA

- Es normal que se originen ruidos cuando el hielo producido cae en el recipiente.

Menu

Podrá seleccionar entre las funciones Información, Recetas, Frigorífico, Configuración de pantalla y Álbum de fotos.



Presione el botón **MENU**.



3 Seleccione el menú utilizando los botones ▲ & ▼.

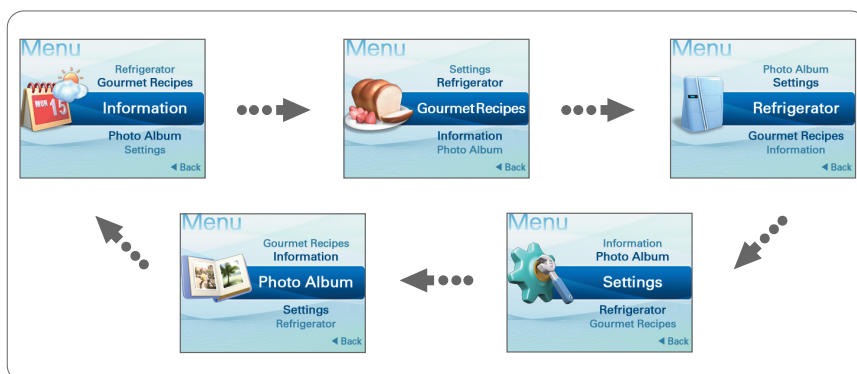

4 Presione el botón **SELECT**.

5 Observará el menú detallado.

Información

Podrá seleccionar entre la función Reporte meteorológico, Recordatorio de aniversario, Ajuste horario y de fecha o Temporizador.

☐ Reporte meteorológico

- Recibe y muestra el reporte meteorológico y de temperatura de 5 días.
- La recepción de información del pronóstico del tiempo recibida que se muestre en la pantalla puede variar dependiendo de su región y de la ubicación de su refrigerador.
- Por lo tanto, LG no garantiza y no será considerado responsable de la exactitud de la información del clima.
- "Información de Pronóstico del tiempo solo esta disponible en E. U. A."



Pulse el botón ▲ o ▼ para seleccionar **Weather Forecast**.

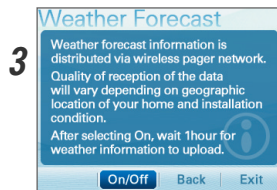

Pulse el botón ◀ o ▶ para seleccionar **On/Off**.

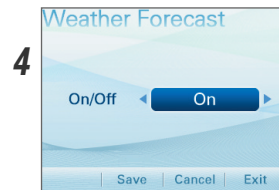

Pulse el botón ◀ o ▶ para seleccionar **On**.



Seleccione la región deseada utilizando el botón ◀ o ▶ .



7 Volver al menú **Information**.

☐ **Recordatorio de aniversario**

- Registre la fecha de su aniversario.
-  Seleccione el recordatorio de aniversario utilizando el botón.

< Para configurar una nueva fecha. >



1



2

Pulse el botón ▲ o ▼ para seleccionar **Anniversary Reminder**.



3



Seleccione el mes utilizando el botón ◀ o ▶.

Presione el botón ▼ y, a continuación, la fecha utilizando el botón ◀ o ▶.



4



5

Seleccione el menú utilizando el botón ▲ o ▼.

Pulse el botón ▼ para seleccionar **Save**.

Seleccione el período de tiempo utilizando el botón ◀ o ▶.

6 Return to the Information menu.

Se activa la alarma recordatorio de aniversario.



La alarma se activará a la hora y fecha configuradas, y el aniversario se mostrará en pantalla.

< Para visualizar la lista de aniversarios >



Pulse el botón ▲ o ▼ para seleccionar **Anniversary Reminder**.



Pulse el botón ▲ o ▼ para seleccionar **List**.



Podrá consultar el menú detalla-do utilizando el botón ◀ o ▶.

☐ **Ajuste horario y de fecha**

Para configurar la fecha y la hora:



Pulse el botón ▲ o ▼ para seleccionar **Data & Time Setting**.



Seleccione el menú utilizando el botón ▲ o ▼.

Seleccione el valor deseado utilizando el botón ◀ o ▶.



Pulse el botón ▼ para seleccionar **Save**.

5 Volver al menú **Information**.

❑ **Temporizador**

Para configurar la alarma:



Pulse el botón ▲ o ▼ para seleccionar **Timer**.

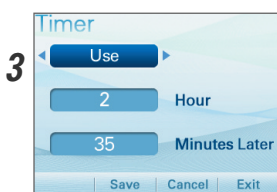

Seleccione la hora deseada utilizando el botón ◀ o ▶.

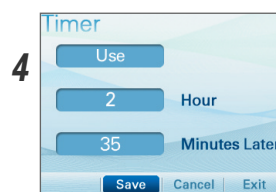

Pulse el botón ▼ para seleccionar **Save**.

5 Volver al menú **Information**.

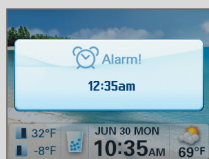

- La alarma se activará a la hora configurada, y la imagen del temporizador se mostrará en pantalla.

Receta

Seleccione la receta después de seleccionar el tipo de plato.

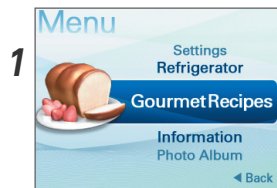

Seleccione el tipo de plato utilizando los botones ▲ o ▼ .



Podrá seleccionar el plato deseado utilizando el botón ◀ o ▶ .



Pulse el botón ▼ para seleccionar **More**.



Podrá seleccionar el menú detallado utilizando el botón ◀ o ▶ .

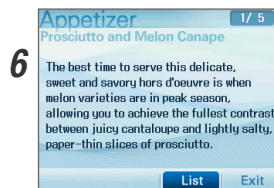

Pulse el botón ▼ para seleccionar **List**.

7 Volver al menú **Gourmet Recipes**.

Refrigerador

Podrá seleccionar entre las funciones Reiniciar el filtro, Alarma de la puerta, Luz del dispensador, Manual y Llamada de servicio.

❑ **Reiniciar el filtro**

Alerta de la fecha de repuesto necesario del filtro.

< **Cuando la fecha de repuesto del filtro aún no haya llegado.** >



Pulse el botón ▲ o ▼ para seleccionar **Filter Reset**.



Pulse el botón ◀ o ▶ para seleccionar **Reset**.

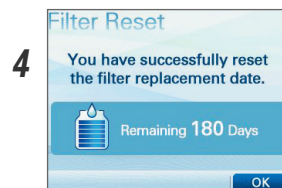

Presione el botón **SELECT**.

5 Volver al menú **Refrigerator**.

< Cuando la fecha de repuesto del filtro haya vencido >



Pulse el botón ▲ o ▼ para seleccionar **Filter Reset**.



Pulse el botón ◀ o ▶ para seleccionar **Reset**.

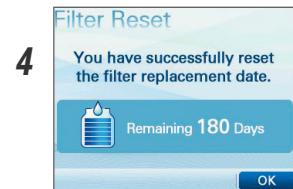

Presione el botón **SELECT**.

5 Volver al menú **Refrigerator**.

- Recibirá un mensaje notificando el cambio del filtro cuando la fecha de repuesto del filtro aún no haya llegado.



Pulse el botón ◀ o ▶ para seleccionar **Reset**.



Presione el botón **SELECT**.

Volver a la pantalla de espera.

- Si selecciona cancelar el ajuste de repuesto del filtro.



Pulse el botón ◀ o ▶ para seleccionar **Later**.

Presione el botón **SELECT**.



Advertirá la señal de repuesto del filtro en la pantalla de espera.

❑ **Alarma de la puerta**

Esta función le advertirá cada 30 segundos si la puerta del refrigerador permanece abierta durante más de 1 minuto.

-  Podrá encender o apagar la alarma de la puerta.

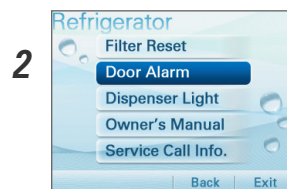

Pulse el botón ▲ o ▼ para seleccionar **Door Alarm**.



Pulse el botón ◀ o ▶ para seleccionar **Use** ou **Not in Use**.

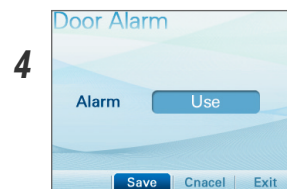

Pulse el botón ▼ para seleccionar **Save**.

5 Volver al menú **Refrigerator**.

- **Recibirá un mensaje de alarma de puerta abierta.**

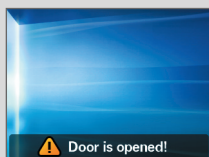

- **Al utilizar la alarma de la puerta**

Esta función le advertirá cada 30 segundos si la puerta del refrigerador permanece abierta durante más de 1 minuto.

- **Cuando no utilice la alarma de la puerta**

La alarma no se activará, incluso si la puerta del refrigerador permaneciera abierta.

☐ **Luz del dispensador**

Esta función controla el LED del dispensador.

-  Presione este icono para encender la luz del dispensador.



Pulse el botón ▲ o ▼ para seleccionar **Dispenser Light**.

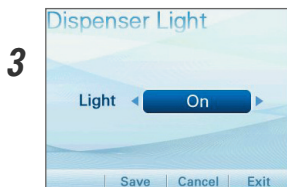

Pulse el botón ◀ o ▶ para seleccionar **On**.

[On] <--> [Off]

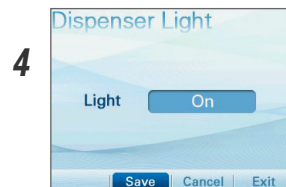

Pulse el botón ▼ para seleccionar **Save**.

5 Volver al menú **Refrigerator**.

- **Cuando haya seleccionado que esté encendida**, la luz del dispensador permanecerá siempre encendida.
- **Cuando haya seleccionado que esté apagada**, la luz del dispensador se encenderá únicamente al presionar la palanca del dispensador.

❑ **Manual**

Podrá seleccionar en la Guía de teclas, Tem. Función de Ajuste, Bloqueo infantil, Reporte meteorológico, Almacenamiento correcto de los alimentos, Guía de mantenimiento del frig-orífico, Guía de mantenimiento del congelador o Eliminación de olores.

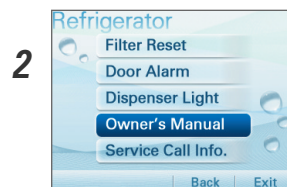

Pulse el botón ▲ o ▼ para seleccionar **Owner's Manual**.

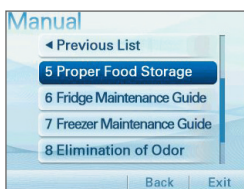
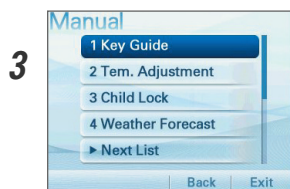

Seleccione el menú utilizando los botones ▲ o ▼.

4 Presione el botón **SELECT**.

5 Seleccione el menú detallado utilizando el botón ◀ o ▶.

6 Pulse el botón ▼ para seleccionar **List**.

7 Volver al menú **Refrigerator**.

1. Guía de teclas

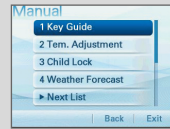

Pulse el botón ▲ o ▼ para seleccionar **Key Guide**.

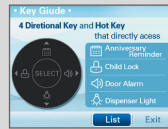

Observará el menú detallado.

2. Ajuste de temp.

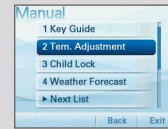

Pulse el botón ▲ o ▼ para seleccionar **Temp. Adjustment**.



Podrá consultar el menú detallado utilizando el botón ◀ ▶.

3. Bloqueo infantil

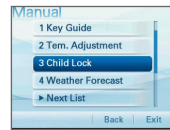

Pulse el botón ▲ o ▼ para seleccionar **Child Lock**.

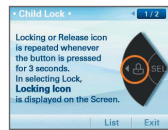

Podrá consultar el menú detallado utilizando el botón ◀ ▶.

4. Reporte meteorológico



Pulse el botón ▲ o ▼ para seleccionar **Weather Forecast**.



Podrá consultar el menú detallado utilizando el botón ◀ ▶.

5. Almacenamiento correcto de los alimentos

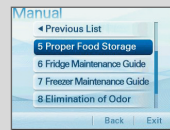

Pulse el botón ▲ o ▼ para seleccionar **Proper Food Storage**.



Podrá consultar el menú detallado utilizando el botón ◀ ▶.

6. Guía de mantenimiento del refrigerador

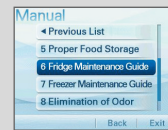

Pulse el botón ▲ o ▼ para seleccionar **Fridge Maintenance Guide**.

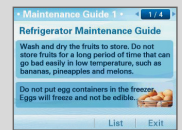

Podrá consultar el menú detallado utilizando el botón ◀ ▶.

7. Guía de mantenimiento del congelador

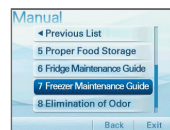

Pulse el botón ▲ o ▼ para seleccionar **Freezer Maintenance Guide**.



Podrá consultar el menú detallado utilizando el botón ◀ ▶.

8. Eliminación de olores



Pulse el botón ▲ o ▼ para seleccionar **Elimination of Odor**.

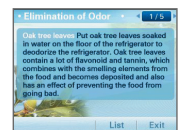

Podrá consultar el menú detallado utilizando el botón ◀ ▶.

☐ **Llamada de servicio**

Esto le facilitará el número de Servicio en EE.UU. o Canadá.

1



2



Pulse el botón ▲ o ▼ para seleccionar **Service Call Info.**

3



Observará el menú detallado.

Configuración de la pantalla

Podrá seleccionar entre la función Modo visualización, Tema en pantalla, Modo ahorro de energía, Luz/Sonido de los botones o °C/°F Configuración de fondo.

1



2



Seleccione el menú utilizando el botón ▲ o ▼.

3



Seleccione y guarde el menú que desee utilizando el botón ◀ o ▶.

4 Volver al menú **Settings.**

☐ **Modo de la pantalla**

Podrá seleccionar la configuración de la pantalla de espera.



Pulse el botón ▲ o ▼ para seleccionar **Display Image**.



Seleccione la foto deseada utilizando el botón ◀ o ▶.

Pulse el botón ▼ para seleccionar **Preview**.



Podrá consultar otra pantalla de espera utilizando el botón ◀ o ▶.



Pulse el botón ▼ para seleccionar **Save**.



☐ **Tema de visualización**

Podrá seleccionar la configuración del tema de la pantalla.



Pulse el botón ▲ o ▼ para seleccionar **Display Theme**.

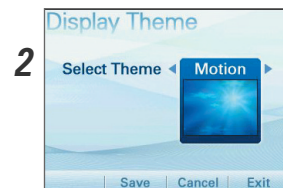

Seleccione el menú utilizando el botón ◀ o ▶.

Pulse el botón ▼ para seleccionar **Save**.

[Character] <--> [Motion]

☐ **Modo ahorro de energía**

Puede seleccionar la función Ahorro de energía.

< Cuando la función Ahorro de energía esté seleccionada. >

- Al seleccionar [Uso del ahorro de energía], la luz de fondo de la pantalla LCD se apagará una vez transcurrido el tiempo establecido.



Pulse el botón ▲ o ▼ para seleccionar **Power Saver**.

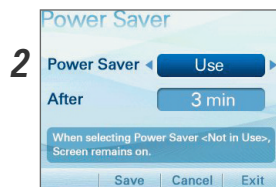

Pulse el botón ◀ o ▶ para seleccionar **Use**.

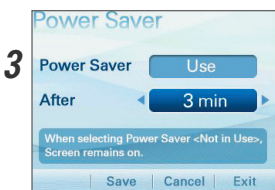

Seleccione el tiempo deseado utilizando el botón ◀ o ▶ .

[1min] <--> [3min] <--> [5min]

4 El Ahorro de energía apagará la pantalla en el momento preestablecido.

< Cuando la función Ahorro de energía no esté seleccionada. >

- Al seleccionar [No usar el ahorro de energía], la pantalla LCD pasará a modo salvapantallas después de un minuto.



Pulse el botón ▲ o ▼ para seleccionar **Power Saver**.

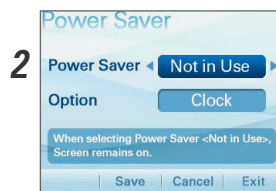

Pulse el botón ◀ o ▶ para seleccionar **Not in Use**.

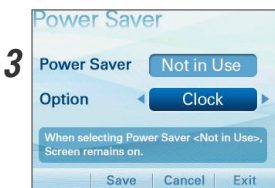

Seleccione el menú utilizando el botón ◀ o ▶ .

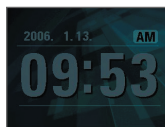

[Clock]

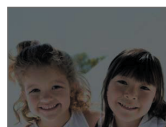

[Photo]



[Not in Use]

Al seleccionar **Not in Use**, la pantalla actual de espera se guardará como salvapantallas.

☐ **Luz/Sonido de los botones**

- Puede ajustar el nivel de brillo de la pantalla.
- Al seleccionar el sonido del botón, podrá encenderlo o apagarlo.

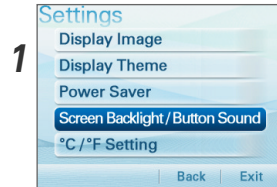

1

Pulse el botón ▲ o ▼ para seleccionar **Screen Backlight/Button Sound**.

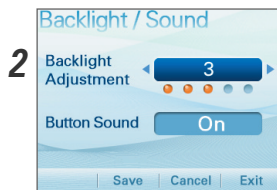

2

Seleccione el valor de la luz utilizando el botón ◀ o ▶.

Pulse el botón ▼ para seleccionar **Save**.

[1 <--> 2 <--> 3 <--> 4 <--> 5]

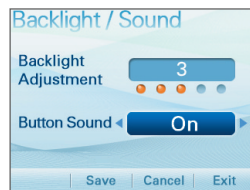

Seleccione y guarde el menú que desee utilizando el botón ◀ o ▶.

[On] <--> [Off]

☐ **°C/°F Configuración**

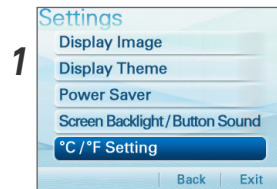

1

Pulse el botón ▲ o ▼ para seleccionar **°C/°F Setting**.



2

Seleccione el valor de la luz utilizando el botón ◀ o ▶.

[Centigrade] <--> [Fahrenheit]

Pulse el botón ▼ para seleccionar **Save**.

Álbum de fotos

Podrá registrar una foto o configurar la pantalla de espera.

< Al configurar en pantalla de espera. >

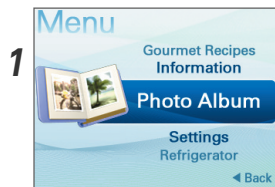

Seleccione la foto deseada utilizando el botón ◀ o ▶.

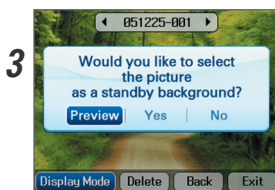

Pulse el botón ▼ para seleccionar **Display Image**.

Pulse el botón ◀ o ▶ para seleccionar **Preview**.



Pulse el botón ◀ ou ▶ para seleccionar **Save**.

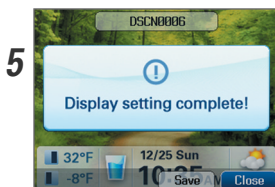

6 Volver a la pantalla de espera.

< Al eliminar >

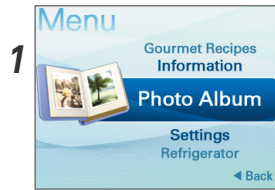

Seleccione la foto deseada utilizando el botón ◀ o ▶.

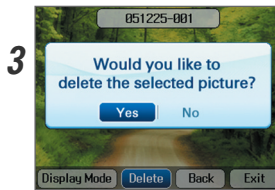

Pulse el botón ▼ para seleccionar **Delete**.

Pulse el botón ◀ o ▶ para seleccionar **Yes**.



Pulse el botón ◀ ou ▶ para seleccionar **Save**.

5 Volver a la pantalla de espera.

< Al eliminar todo >

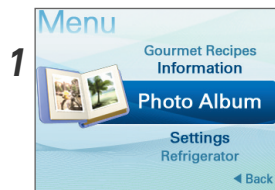

Pulse el botón ▼ para seleccionar **Delete All**.

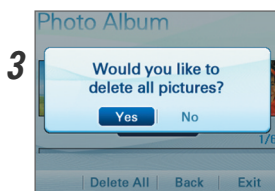

Pulse el botón ◀ o ▶ para seleccionar **Yes**.

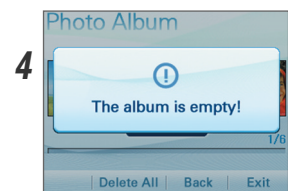

Volver a la pantalla de espera.

< Al registrar la foto. >



Al conectar el cable USB al puerto USB, éste lee los datos de la foto y los añade a la lista del álbum.

< Al utilizar el puerto USB >

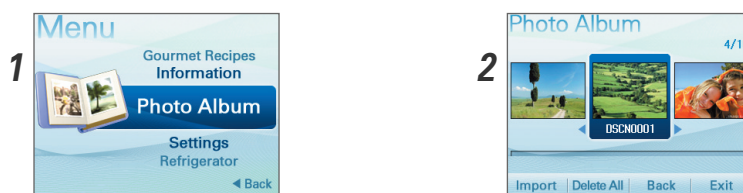

Al seleccionar **Photo Album** y a continuación conectar el Puerto USB, se activará la función **Import** elemento.

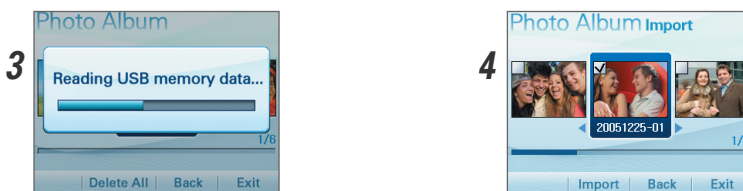

Al seleccionar **Import**, se leerán los datos del Puerto USB. La pantalla desplegable aparecerá para informarle del curso del proceso durante la lectura.

Después de configurar la foto deseada de los datos leídos, seleccione la acción **Import**.



Después de que aparezca la pantalla emergente **Control de Import**, podrá comprobar la foto desde la lista del álbum de fotos.

- Posición del puerto USB del refrigerador.
- Si desea utilizar el puerto USB, seleccione primero el elemento del álbum de fotos y, a continuación, inserte el puerto USB.
- El sistema tardará varios segundos en leer la foto desde el puerto USB.
- En ocasiones, su puerto USB puede no ser compatible.
- Conecte al USB el producto donde tiene guardada la foto. Si las fotos no se guardaran, guárdelas primero en el puerto USB.



Bloquear

Utilícelo para bloquear otros botones.

-  Seleccione Bloqueo mediante los botones.
- Bloquee o desbloquee los botones y el dispensador manteniendo presionado el botón durante 3 segundos.
- Cuando la opción de bloqueo es seleccionada, el dispensador y los botones se bloquearán y no funcionarán.
- Cuando la opción de bloqueo sea seleccionada, el icono de bloqueo aparecerá en la pantalla.

< Para configurar el Bloqueo >

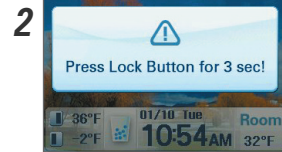

Cuando reciba este mensaje, presione el botón Bloqueo durante 3 segundos.

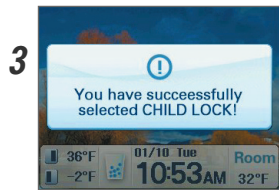

4 Volver a la pantalla de espera.

Podrá observar este mensaje.

< Para cancelar el Bloqueo >

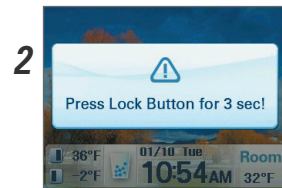
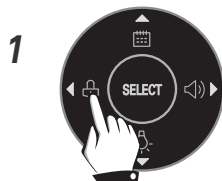

Cuando reciba este mensaje, presione el botón Bloqueo durante 3 segundos.

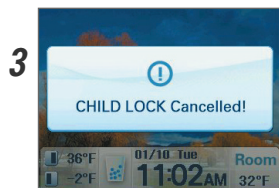

4 Volver a la pantalla de espera.

Podrá observar este mensaje.

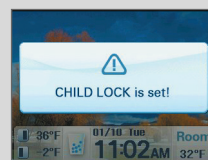

Si presiona el botón Refrigerador cuando el Bloqueo está configurado, se mostrará en pantalla este mensaje.

Otras funciones

Ventana indicadora de temperatura ambiente.

- La temperatura sólo se muestra entre 16°F ~ 120°F (-9°C ~ 49°C).
- Las temperaturas inferiores a 15°F (-9°C) se indican con LO (BAJA) y las superiores a 121°F (49°C) se indican con HI (ALTA).

**Función de diagnóstico (detección de errores)**

- La función de diagnóstico detecta errores automáticamente durante la utilización de la unidad.
- Si se detecta un error, no desconecte la alimentación. Póngase en contacto con un servicio técnico autorizado o llame a nuestro teléfono de asistencia técnica. Si apaga la unidad, será más difícil para el técnico determinar cuál es el problema.

Suministro de hielo/agua fría

El agua se enfría mientras está almacenada en el depósito de agua de la puerta del congelador, y a continuación se envía al dispensador.

El hielo se produce en la máquina automática de hielo, y se envía al dispensador.

Precauciones

Tire el hielo (20 cubitos aproximadamente) y el agua (7 vasos aproximadamente) obtenidos inicialmente después de la instalación del refrigerador.

Esto también es necesario cuando el refrigerador no se ha utilizado durante un largo período de tiempo.

Mantenga a los niños alejados del suministrador.

Es posible que jueguen con los controles y los dañen.

Tenga cuidado de que los alimentos no bloqueen el conducto del hielo.

Si los alimentos se colocan a la entrada del conducto del hielo, pueden producirse errores en el funcionamiento del suministrador. También es posible que se obstruya el conducto con escarcha si sólo se utiliza hielo triturado. Retire la escarcha acumulada.

Si se colocan latas de bebidas u otros productos en el recipiente del hielo, se puede dañar el suministrador de hielo o pueden explotar las latas.**No utilice vasos de cristal fino ni loza para recoger el hielo.**

Este tipo de contenedores pueden romperse.

Coloque hielo en un vaso antes de llenarlo de agua u otro tipo de bebida.

Es posible que se derrame líquido si se añade hielo a un vaso que ya contenga hielo.

No acerque las manos ni herramientas al compartimento ni al conducto del hielo.

Podría romper algún componente o dañarse.

No retire nunca la cubierta del suministrador de hielo.**Sacuda el recipiente del hielo de vez en cuando para que éste se distribuya uniformemente.**

A veces, el hielo se amontona cerca del suministrador de hielo, haciendo que éste detecte el nivel del recipiente incorrectamente y deje de producir hielo.

Si se suministra agua o hielo presentando algún tipo de coloración, póngase en contacto con un servicio técnico oficial y no utilice el dispensador hasta que se haya solucionado el problema**No utilice vasos estrechos o muy altos.**

El hielo se puede atascar en el conducto de salida, por lo que el refrigerador no funcionaría correctamente.

Mantenga el vaso a una distancia adecuada de la salida del hielo.

Si se acercan demasiado los vasos, se puede dificultar el suministro de hielo.

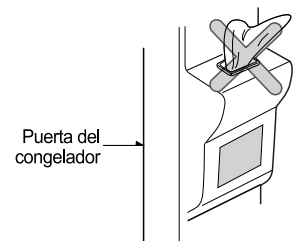

Ajuste de la altura de las bandejas

Bandeja

La bandeja del compartimento refrigerador es móvil, de manera que se puede colocar a la altura deseada, dependiendo de las necesidades de espacio para los distintos productos.

- Estante deslizante
Tire del estante y sáquelo levantando el frente y la parte posterior.

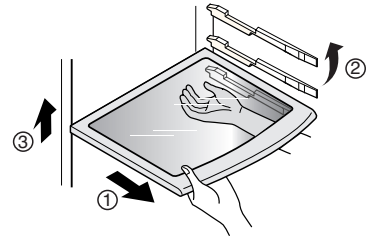

- Estante fija, Estante plegable
Levante un poco la parte frontal del estante, tire de él y sáquelo levantando la parte posterior.

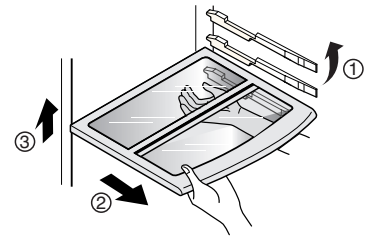

NOTA

- Compruebe que la bandeja está en posición horizontal. De lo contrario puede caerse.

Estante plegable

Esta estante le permitirá almacenar elementos de mayor tamaño, como recipientes de un galón o botellas altas. Simplemente empuje la mitad frontal de la bandeja bajo ella misma, deslizándola. Para extraer la mitad inferior únicamente deberá tirar de ella.

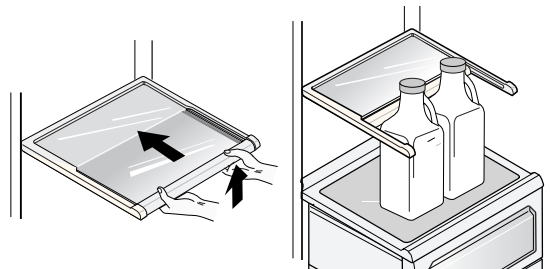

Control de la humedad en el compartimento de verdura

Se puede controlar la humedad girando el control de humedad hacia la izquierda o hacia la derecha al almacenar verdura o fruta.

Más humedad

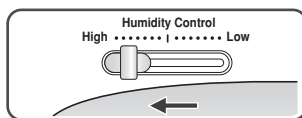

Menos humedad

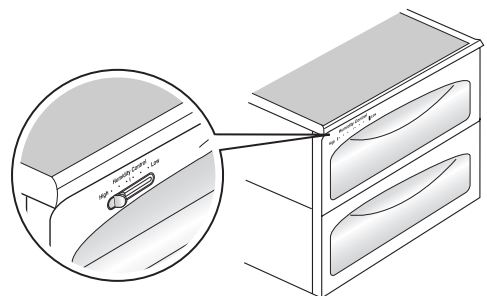
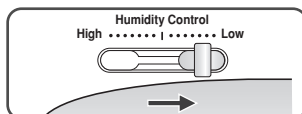

Temperatura del compartimento OptiFresh

Método a utilizar

Usted puede seleccionar la mejor temperatura para almacenar cierto tipo de alimentos.

- Verduras, frutas, y otros elementos de almacenamiento en frío requieren un mantenimiento del nivel de humedad, y pueden almacenarse bajo las mejores condiciones presionando el botón.

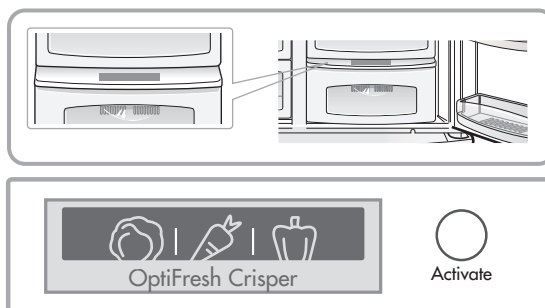

- Si abre la puerta del refrigerador, un indicador luminoso mostrará el estado del OptiFresh. La luz se apagará una vez que se cierre la puerta.
- Pulse el botón para iniciar el ciclo de **ENCENDIDO**→ **APAGADO**→ **ENCENDIDO**.

OptiFresh

Desensamble del OptiFresh

- Primero, retire el cajón para verduras.
- A continuación, sujete la parte posterior y frontal del OptiFresh ① y ② extráigalo.

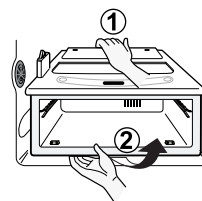

Instalación del OptiFresh

- Ajuste el compartimento OptiFresh contra el borde ① y deslícelo suavemente ② .
- Si lo forza podría dañar las piezas de conexión.

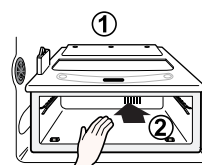

Colocación de los alimentos

(Consulte la sección Identificación de las piezas)

Compartimento mediano

Guarde alimentos pequeños como pan, tentempiés, etc.

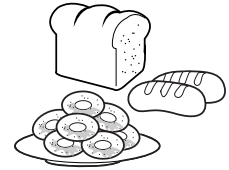

Bandeja del compartimento congelador

Guarde varios tipos de alimentos congelados como carne, pescado, helado, tentempiés congelados, etc.



Estantería de la puerta del compartimento congelador

Guarde pequeños envases de alimentos congelados.



Cajón del compartimento congelador

Guarde carne, pescado, pollo, etc. después de envolverlo en papel de aluminio.



Guarde los productos secos.



Compartimento de productos lácteos

Guarde productos lácteos como mantequilla y queso.



Compartimento de refrescos

Guarde alimentos utilizados frecuentemente como bebidas.



Bandeja del compartimento refrigerador

Guarde guarniciones u otros tipos de alimentos a una distancia adecuada.

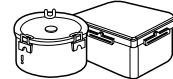

Estantería de la puerta del compartimento refrigerador

Guarde pequeños envases de alimentos o bebidas como leche, jugo, cerveza, etc.

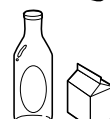

Compartimento de verdura

Guarde fruta o verdura.



Almacenamiento de los alimentos

- Almacene alimentos frescos en el compartimento refrigerador. El método de congelación y descongelación de los alimentos es un factor importante para conservar la frescura y el sabor.
- No guarde alimentos que se estropeen fácilmente a temperaturas bajas, como plátanos y melones.
- Deje que los alimentos calientes se enfríen antes de guardarlos, ya que, de lo contrario, se podrían estropear otros alimentos y provocar un mayor consumo de energía.
- Al guardar los alimentos, cúbralos con una película plástica o guárdelos en un contenedor con tapa. De esta forma, se evita la evaporación de la humedad y se contribuye a la conservación del sabor y los nutrientes.
- No bloquee los conductos de ventilación con alimentos. La circulación del aire frío contribuye a mantener una temperatura constante en el refrigerador.
- No abra la puerta con demasiada frecuencia. La apertura de la puerta permite que el aire caliente entre en el refrigerador, haciendo que se eleve la temperatura interior.
- No coloque demasiados alimentos en la estantería de la puerta, ya que es posible que choquen con las estanterías interiores y la puerta no se cierre completamente.

Compartimento congelador

- No guarde botellas en el congelador, pueden romperse al congelarse.
- No vuelva a congelar alimentos ya descongelados. Perderán su sabor y nutrientes.
- Cuando guarde alimentos congelados como nieve o helado, durante periodos prolongados de tiempo, colóquelos en la puerta del congelador, no en el estante de la puerta.
- No toque alimentos o envases fríos – especialmente los metálicos - con las manos mojadas, ni coloque recipientes de cristal en los cajones del congelador.
 - Esto podría producirle lesiones en la piel, ya que estos envases pueden llegar a romperse si se congelan y causar daños personales.

Compartimento refrigerador

- No coloque alimentos humedecidos en las bandejas superiores del compartimento refrigerador, ya que se pueden congelar como resultado del contacto directo con el aire frío.
- Limpie siempre los alimentos antes de introducirlos en el refrigerador. La fruta, la verdura y los alimentos envasados deben limpiarse para evitar que los alimentos contiguos se estropeen.
- Al guardar huevos en la charola para huevos o en la estantería adecuada, compruebe que sean frescos y guárdelos siempre en posición vertical para mantenerlos frescos durante más tiempo.

NOTA

- Si el refrigerador se encuentra en una zona caliente y húmeda, la apertura frecuente de la puerta o el almacenamiento de gran cantidad de verdura puede contribuir a la formación de condensación, aunque ésta no influye en el funcionamiento del refrigerador. Elimine la condensación con un trapo limpio.

Desinstalación de las piezas

NOTA

- La desinstalación se realiza siguiendo los pasos del ensamble de manera inversa. Compruebe que el cable de alimentación está desenchufado antes de comenzar el ensamble o la desinstalación. No force las piezas para desensamblarlas. Éstas podrían resultar dañadas.

Lámpara del compartimento congelador

Retire la lámpara tirando de ella hacia fuera ② mientras sujeta suavemente ① y hace girar ① la cubierta.

Gire el foco en el sentido contrario a las agujas del reloj. Utilice focos para refrigeradores de potencia máxima de 40 W que se pueden adquirir en los servicios técnicos.

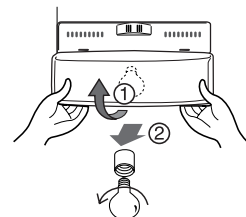

Bandeja del compartimento congelador

Para retirar una bandeja, eleve ligeramente la parte izquierda de la bandeja, empujela en la dirección ①②, eleve la parte derecha en la dirección ③ y júlela hacia afuera.

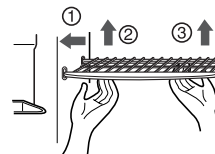

Estantería de la puerta

Eleve la estantería de la puerta sujetándola por ambos lados ① y júlela en la dirección ②.

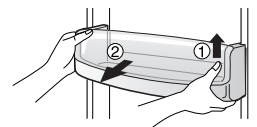

Depósito de almacenamiento de hielo

Sujete el depósito de almacenamiento de hielo como muestra la figura derecha y extráigalo ② mientras lo eleva ligeramente ①.

- Se recomienda no desensamblar el depósito de almacenamiento de hielo a menos que sea absolutamente necesario.
- Utilice ambas manos para desensamblar el depósito de almacenamiento de hielo para evitar que se caiga.

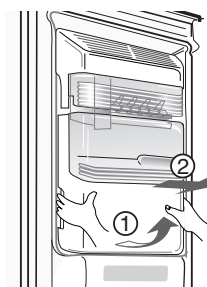

Después de utilizar el dispensador

El colector de agua no cuenta con una función de drenaje. Se debe limpiar con regularidad. Retire la cubierta jalándolo de la parte frontal del colector y séquelo con un paño.

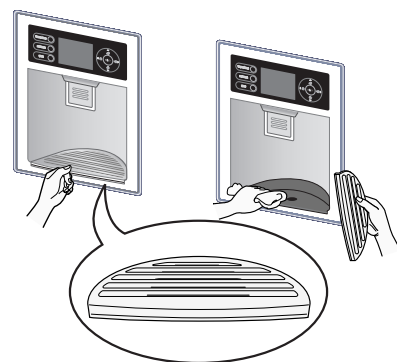

Luz superior del compartimento del refrigerador

Para retirar la cubierta de la luz, extráigala hacia delante mientras presiona la parte inferior de la cubierta hacia arriba. Gire la cubierta del foco hacia la izquierda. Utilice un foco de 40 W (máx.), que puede adquirir en cualquier centro de servicio.

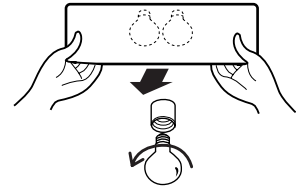

Luz inferior del compartimento del refrigerador

Separe la cubierta de la luz sujetando ambos lados inferiores y jalando hacia delante, para extraerla. Gire la cubierta del foco hacia la izquierda. Utilice un foco de 40 W (máx.), que puede adquirir en cualquier centro de servicio.

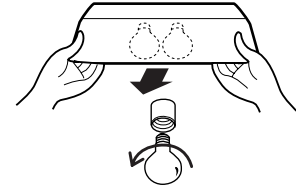

NOTA

- Asegúrese de retirar las piezas de la puerta del refrigerador al desmontar el cajón para verduras, aperitivos y la cubierta del centro de refrescos.

Cubierta del compartimento de verdura

- Para retirar la cubierta del compartimento de verdura, jale ligeramente hacia delante del compartimento ①, eleve la parte frontal de la cubierta como se muestra ② y retírela.

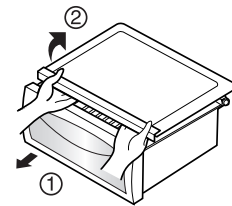

Cambio del filtro

Es recomendable cambiar el filtro cuando el indicador del filtro de agua se enciende o cuando el dispensador de agua o el refrigerador reducen su capacidad notablemente.

Después de cambiar el cartucho del filtro de agua, reajuste la pantalla del estado del filtro y el indicador presionando el BOTÓN durante 3 segundos.

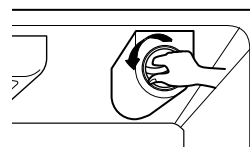

1) Extracción del cartucho usado.

Gire el botón del cartucho en sentido contrario al reloj.

Una vez extraído el cartucho, oír que se suelta de su lugar. Extráigalo.

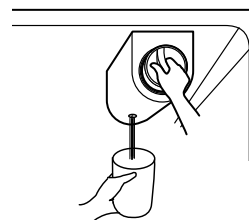

NOTA

- El recambio del filtro causa una pequeña acumulación de agua (unos 25cc) de drenaje. Coloque un recipiente debajo del orificio para evitar que el agua se desborde.

2) Colocación de un nuevo cartucho.

Extraiga el cartucho de su paquete y retire la tapa protectora de los anillos. Con el botón del cartucho en posición vertical, insértelo en la cubierta hasta que encaje en su lugar.

Si el cartucho no está bien colocado, no lo podrá girar de lado a lado. Empújelo y gírelo hasta que encaje en su lugar. Cuando esté en su posición, oír una clic. Con el asa, gire el cartucho hacia la izquierda 1/4 de vuelta. Cuando esté en su posición, oír una clic.

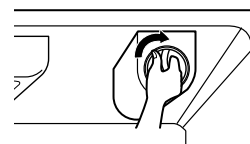
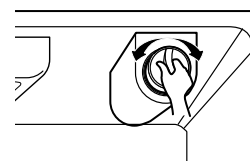

3) Después de colocar el nuevo filtro, limpie el sistema de agua dejando pasar agua a través del dispensador durante 3 minutos.

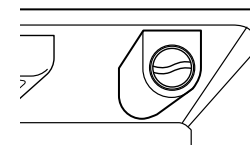

Información general

Durante las vacaciones

Durante unas vacaciones de duración media, es probable que decida dejar el refrigerador funcionando. Coloque en el congelador los alimentos que se puedan congelar para que sean más duraderos. Cuando no desee utilizar el refrigerador, retire todos los alimentos, desconecte el cable de alimentación, limpie el interior en profundidad y bloquee la apertura de las puertas para evitar la formación de moho. Asegúrese de que el refrigerador no represente ningún peligro para que un niño se quede encerrado.

Corte del suministro eléctrico

La mayoría de los cortes del suministro eléctrico que se solucionan al cabo de una hora o dos no afectan a la temperatura del refrigerador. Sin embargo, debe abrir las puertas lo menos posible cuando no haya corriente.

Mudanza

Retire o inmovilice todos los elementos sueltos en el interior del refrigerador. Para evitar que se dañen las roscas de ajuste de altura, empújelas hacia el interior de la base.

Tubería anticondensación

La cubierta exterior del refrigerador puede llegar a calentarse, especialmente después de la instalación. No se alarme. Esto se debe a que la tubería de anticondensación bombea líquido refrigerante caliente para evitar la condensación en la cubierta exterior.

Limpieza

Es importante conservar el refrigerador limpio para evitar olores no deseados. Los alimentos derramados se deben limpiar inmediatamente, ya que pueden oxidar y manchar las superficies de plástico si se dejan secar.

Exterior

Utilice una solución tibia de detergente o jabón suave para limpiar la superficie del refrigerador. Límpiela con un trapo mojado y, a continuación, séquela.

Interior

Es recomendable limpiar con regularidad. Lave todos los compartimentos con una solución de bicarbonato o detergente suave y agua caliente. Lávelos y séquelos.

Después de la limpieza

Compruebe que el cable de alimentación no está dañado y que el enchufe no se ha sobrecalentado y está bien conectado a la toma de corriente.

Advertencia

Retire siempre el cable de alimentación de la toma de corriente antes de limpiar alrededor de los componentes eléctricos (lámparas, interruptores, mandos, etc.). Limpie el exceso de humedad con una esponja o con un trapo para evitar que se introduzcan líquidos en ninguna pieza eléctrica y se produzca una descarga eléctrica. No utilice en ninguna de las superficies estropajos metálicos, cepillos, limpiadores abrasivos, soluciones alcalinas fuertes ni líquidos inflamables o tóxicos. No toque las superficies congeladas con las manos mojadas, ya que los objetos mojados se adhieren a las superficies muy frías.

Solución de problemas

Consulte esta lista de problemas antes de llamar al servicio técnico. Puede ahorrarle tiempo y dinero. En esta lista se incluyen problemas comunes que no están ocasionados por una fabricación o piezas defectuosas en esta unidad.

Incidencia	Posible causa	Solución
Funcionamiento del refrigerador		
El compresor del refrigerador no funciona.	El control del refrigerador está desactivado.	Configure el control del refrigerador. Consulte la configuración de los mandos.
	El refrigerador se encuentra en el ciclo de descongelación.	Es normal en un refrigerador con descongelación completamente automática. El ciclo de descongelación se repite periódicamente.
	El enchufe de alimentación no está conectado.	Compruebe que el enchufe esté bien introducido en la toma de corriente.
	Corte del suministro eléctrico. Compruebe las luces de la vivienda.	Póngase en contacto con la compañía eléctrica local.
El refrigerador funciona durante mucho tiempo	El refrigerador es más grande que el anterior.	Esto es normal. Los electrodomésticos de mayor tamaño y eficacia funcionan durante más tiempo en estas condiciones.
	La temperatura ambiente o la exterior es elevada.	Es normal que el refrigerador funcione durante más tiempo en estas condiciones.
	El refrigerador ha permanecido desconectado durante un largo período de tiempo.	El refrigerador tarda unas horas en enfriarse por completo.
	Es posible que se hayan guardado grandes cantidades de alimentos templados o calientes recientemente.	Los alimentos calientes hacen que el refrigerador funcione durante más tiempo hasta alcanzar la temperatura programada.
	Las puertas se abren con demasiada frecuencia o durante demasiado tiempo.	El aire caliente que entra en el refrigerador hace que éste funcione durante más tiempo. Abra la puerta con menor frecuencia.
	Es posible que la puerta del refrigerador o la del congelador esté ligeramente abierta.	Compruebe que el refrigerador está bien nivelado. No bloquee la puerta con alimentos ni contenedores. Consulte la sección de problemas. Apertura y cierre de las puertas.
	El mando del refrigerador está ajustado a temperatura muy baja.	Ajuste el control de temperatura del refrigerador a una temperatura más elevada hasta que ésta sea la correcta.
	La junta del refrigerador o del congelador está sucia, desgastada, agrietada o mal ajustada.	Limpie o cambie la junta. Las fugas en el sello de la puerta hacen que el refrigerador funcione durante más tiempo para poder conservar las temperaturas deseadas.
	El termostato mantiene el refrigerador a temperatura constante.	Esto es normal. El refrigerador se activa y se desactiva para mantener la temperatura constante.

Incidencia	Posible causa	Solución
El compresor del refrigerador no funciona.	El termostato mantiene el refrigerador a temperatura constante.	Esto es normal. El refrigerador se activa y se desactiva para mantener la temperatura constante.

Las temperaturas son demasiado frías

La temperatura en el congelador es demasiado fría, pero la del refrigerador es correcta.	El control del congelador está ajustado a temperatura muy baja.	Ajuste el control del congelador a una temperatura más elevada hasta que ésta sea la correcta.
La temperatura en el refrigerador es demasiado fría, pero la del congelador es correcta.	El control de temperatura refrigerador está ajustado a temperatura muy baja.	Ajuste el control del refrigerador a una temperatura más elevada
Los alimentos guardados en los compartimentos se congelan.	El control de temperatura refrigera está ajustado a temperatura muy baja.	Consulte la solución anterior.

Las temperaturas son demasiado elevadas

Las temperaturas en el refrigerador o en el congelador son demasiado elevadas.	El control del congelador está ajustado a temperatura muy elevada.	Ajuste el control del congelador o del refrigerador a una temperatura más baja hasta que ésta sea la correcta.
	El control del refrigerador está ajustado a temperatura muy elevada. El control del refrigerador influye ligeramente en la temperatura del congelador.	Ajuste el control del congelador o del refrigerador a una temperatura más baja hasta que ésta sea la correcta.
	Las puertas se abren con demasiada frecuencia o durante demasiado tiempo.	Entra aire caliente en el refrigerador / congelador al abrir la puerta. Abra la puerta con menor frecuencia.
	La puerta está ligeramente abierta.	Cierre la puerta completamente.
	Es posible que se hayan guardado grandes cantidades de alimentos templados o calientes recientemente.	Espere hasta que el refrigerador o el congelador alcancen la temperatura programada.
	El refrigerador ha permanecido desconectado durante un largo período de tiempo.	El refrigerador tarda unas horas en enfriarse por completo.
La temperatura en el refrigerador es demasiado elevada, pero la del congelador es correcta.	El control del refrigerador está ajustado a temperatura muy elevada.	Ajuste el control del refrigerador a una temperatura más baja.

Incidencia	Posible causa	Solución
------------	---------------	----------

Ruidos

Niveles sonoros más elevados durante el funcionamiento.	Los refrigeradores actuales cuentan con una mayor capacidad de almacenamiento y conservan las temperaturas más constantes.	Es normal que los niveles acústicos sean mayores.
Niveles sonoros más elevados durante el funcionamiento del compresor.	El refrigerador funciona a presiones más elevadas durante el inicio del ciclo de activación.	Esto es normal. El sonido se estabilizará a medida que prosigue el funcionamiento del refrigerador.
Ruido de vibraciones o traqueteo.	El suelo es irregular o poco sólido. El refrigerador se balancea en el suelo cuando se desplaza ligeramente.	Compruebe que el suelo sea regular y sólido y que reúna las condiciones adecuadas para colocar el refrigerador.
	Los artículos colocados en la parte superior del refrigerador vibran.	Retire los artículos.
	Los platos vibran en las bandejas del refrigerador.	Es normal que los platos vibren ligeramente. Muévelos ligeramente. Compruebe que el refrigerador esté bien nivelado y colocado firmemente en el suelo.
	El refrigerador está en contacto con la pared o los muebles.	Mueva el refrigerador para que no esté en contacto con la pared o los muebles.

Agua, humedad o hielo dentro del refrigerador

La humedad se forma en las paredes interiores del refrigerador.	El tiempo es caluroso y húmedo, lo cual aumenta la acumulación de escarcha y la condensación interna.	Esto es normal.
	La puerta está ligeramente abierta.	Consulte la sección de solución de problemas Apertura y cierre de las puertas.
	La puerta se abre con demasiada frecuencia o durante demasiado tiempo.	Abra la puerta con menor frecuencia.

Agua, humedad o hielo fuera del refrigerador

Se forma humedad en el exterior del refrigerador o entre las puertas.	El tiempo es húmedo.	Esto es normal cuando el tiempo es húmedo. Cuando la humedad es menor, la humedad en el refrigerador debería desaparecer.
	La puerta está ligeramente abierta, lo que hace que el aire frío del interior entre en contacto con el aire caliente del exterior.	Cierre la puerta completamente.

Incidencia	Posible causa	Solución
------------	---------------	----------

Olores en el refrigerador

	Es necesario limpiar el interior.	Limpie el interior con una esponja, agua caliente y bicarbonato.
	Hay algún alimento de olor fuerte en el refrigerador.	Cubra los alimentos por completo.
	Algunos contenedores o envoltorios producen olores.	Utilice un contenedor diferente u otra marca de material para envolver.

Apertura y cierre de las puertas y los compartimentos

Las puertas no se cierran.	Algún envase mantiene la puerta abierta.	Mueva los envases que impiden que la puerta se cierre.
Las puertas no se cierran.	Se ha cerrado una de las puertas con demasiada fuerza, haciendo que la otra puerta se abra ligeramente.	Cierre las puertas suavemente.
	El refrigerador no está bien nivelado. Se balancea en el suelo cuando se desplaza ligeramente.	Gire la rosca de ajuste de altura.
	El suelo es irregular o poco sólido. El refrigerador se balancea en el suelo cuando se desplaza ligeramente.	Compruebe que el suelo sea regular y que reúna las condiciones adecuadas para colocar el refrigerador. Póngase en contacto con un carpintero para corregir el combamiento o la inclinación del suelo.
	El refrigerador está en contacto con la pared o los muebles.	Mueva el refrigerador.
Los compartimentos se abren con dificultad.	Hay algún alimento en contacto con la bandeja encima del compartimento	Guarde menos alimentos en el cajón.
	La ranura sobre la que se desliza el cajón está sucia.	Limpie el cajón y la ranura.

Suministrador

No sale hielo del suministrador	El recipiente del hielo está vacío.	El suministrador debería funcionar cuando se haya producido hielo por primera vez.
	La temperatura del congelador es demasiado elevada.	Ajuste el control del congelador a menor temperatura para que se produzca hielo. El suministrador debería funcionar cuando se haya producido hielo por primera vez y se coloque en el recipiente del hielo.
	La válvula de la tubería del suministro de agua no está abierta.	Abra la válvula de la tubería de suministro de agua y espere a que se forme el hielo. Una vez que se ha formado el hielo, el suministrador debería funcionar.
	La puerta del refrigerador o del congelador no está cerrada.	Compruebe que las dos puertas están cerradas.

Incidencia	Posible causa	Solución
No sale hielo del suministrador.	El hielo se ha derretido y se ha vuelto a congelar debido al uso poco frecuente, las variaciones de temperatura o los cortes del suministro eléctrico.	Retire el recipiente del hielo y descongele el contenido. Límpielo y séquelo y vuelva a colocarlo en su sitio. Una vez que se ha formado hielo de nuevo, el suministrador deberá funcionar.
El suministrador de hielo está atascado.	Los cubitos de hielo están atascados entre el brazo interno del suministrador de hielo y la parte posterior del recipiente del hielo.	Retire los cubitos de hielo que están obstruyendo el suministrador.
	Los cubitos se congelan en bloque.	Utilice el suministrador con frecuencia para que los cubitos no se agrupen.
	Se han introducido en el suministrador cubitos de hielo comprados o formados de algún otro modo.	Sólo se deben utilizar los cubitos de hielo que produce el suministrador.
No sale agua del suministrador.	La válvula de la tubería del suministro de agua no está abierta. Consulte el problema El suministrador de hielo no produce hielo.	Abra la válvula del suministro de agua.
	La puerta del refrigerador o del congelador no está cerrada.	Compruebe que las dos puertas están cerradas.
El agua presenta un sabor y olor extraños.	El agua lleva demasiado tiempo en el depósito.	Llene y tire la medida de 7 vasos de agua para renovar el suministro. Llene y tire 7 vasos de agua más para limpiar el depósito por completo.
	El refrigerador no está conectado adecuadamente al suministro de agua fría.	Conecte el refrigerador a la tubería de agua fría que suministra el agua del grifo de la cocina.
Sonido del hielo al caer	Este sonido se produce normalmente cuando el hielo producido cae en el recipiente del hielo. El volumen puede variar dependiendo de la ubicación del refrigerador.	
Sonido del suministro de agua	Este sonido se produce normalmente cuando se aporta agua al suministrador de hielo después de producir hielo y colocarlo en el recipiente del hielo.	
Otros	Lea detenidamente las secciones correspondientes al suministrador de hielo automático.	

Pronóstico meteorológico

La función no es operativa

La recepción y visualización en pantalla del pronóstico meteorológico está sujeta a variaciones según su región y la ubicación de su frigorífico. Compruebe su código postal en las páginas 151 de este manual o en www.ambientdevices.com/cat/device/coverage.html

NÚMEROS DE ATENCIÓN AL CLIENTE:

<http://www.lgservice.com>

- Para disfrutar de la cobertura de la garantía
Guarde la factura para conservar una prueba de la fecha de la compra.
Debe entregar una copia de la factura de compra al recibir la asistencia técnica de la garantía.
- Para disfrutar de la atención al cliente o la asistencia técnica o del producto
Llame al número gratuito de atención al cliente: 1-800-243-0000
- Para ponerse en contacto con el servicio técnico autorizado más cercano
Llame al 1-800-243-0000, pulse la opción nº 1, 24 horas al día, 7 días a la semana.
Tenga preparado el tipo de producto (monitor, televisor, vídeo, horno microondas, refrigerador) y el código postal.

LG ELECTRONICS, INC.
REFRIGERADOR LG, GARANTÍA LIMITADA - EE.UU.



Su Refrigerador LG será reparado o reemplazado, a la opción de LG, si se encuentra que está defectuoso en cuanto a materiales o mano de obra, en uso normal durante el período de garantía ("Período de Garantía"), establecido a continuación, vigente desde la fecha de compra ("la Fecha de Compra") por parte del consumidor original del producto. Esta garantía se aplica sólo al comprador original del producto y está vigente sólo cuando sea usado en EE.UU., incluyendo Alaska, Hawai, y los Territorios de EE.UU.

<p>PERÍODO DE GARANTÍA: REFRIGERADOR/CONGELADOR</p> <p>MANO DE OBRA: Un año a partir de la Fecha de compra.</p> <p>PIEZAS: Un año a partir de la Fecha de compra.</p> <p>SISTEMA SELLADO (Compresor, Condensador, y Evaporador)</p> <p>MANO DE OBRA: Un año a partir de la Fecha de compra.</p> <p>PIEZAS: Siete años a partir de la Fecha de compra.</p> <p>Las Unidades de reemplazo y los Repuestos están garantizados por la porción restante del período de garantía de la unidad original.</p>	<p>CÓMO SE MANEJA EL SERVICIO:</p> <p>Servicio en casa (Excepto el Modelo GR051): Por favor, guarde del contrato de compra-venta fechado del distribuidor, o el comprobante de entrega fechado como evidencia de la Fecha de compra para comprobación de la garantía, y presente una copia del contrato de compra-venta al técnico del servicio de mantenimiento al momento en que se proporcione el servicio en garantía.</p> <p>Por favor, llame al 1-800-243-0000 y escoja la opción apropiada para localizar su Centro de Servicio Autorizado de LG más cercano. (Los teléfonos son atendidos las 24 horas al día, 365 días al año.)</p>
---	---

SE OTORGA ESTA GARANTÍA EN LUGAR DE TODAS LAS DEMÁS GARANTÍAS, EXPRESAS O IMPLÍCITAS, INCLUYENDO SIN LIMITACIÓN, CUALQUIER GARANTÍA DE COMERCIALIZACIÓN O IDONEIDAD PARA UN PROPÓSITO ESPECÍFICO. HASTA EL PUNTO DE QUE CUALQUIER GARANTÍA IMPLÍCITA SEA REQUERIDA POR LA LEY, SE LIMITA EN DURACIÓN AL EXPRESO PERÍODO DE GARANTÍA INDICADO ARRIBA. NI EL FABRICANTE NI SU DISTRIBUIDOR EN EE.UU. SERÁN RESPONSABLES POR DAÑOS CONSECUENCIALES O INCIDENTALES, INDIRECTOS, ESPECIALES, NI POR DAÑOS PUNITIVOS DE NINGUNA NATURALEZA, INCLUYENDO SIN LIMITACIÓN, RENTAS O GANANCIAS PERDIDAS, O DE CUALQUIER OTRO DAÑO BASADO EN CONTRATO, ENTUERTO, O DE OTRA MANERA. Algunos estados no permiten exclusiones ni limitaciones de daños y perjuicios consecuenciales o incidentales, o limitaciones en cuánto a la duración de una garantía implícita, por lo cual es posible que las exclusiones y limitaciones precedentes no sean aplicables en su caso. Esta garantía le da derechos legales específicos, pero usted también puede tener otros derechos que varían de un estado a otro.

La recepción de información del pronóstico del tiempo recibida que se muestre en la pantalla puede variar dependiendo de su región y de la ubicación de su refrigerador. Por lo tanto, LG no garantiza y no será considerado responsable de la exactitud de la información del clima. "Información de Pronóstico del tiempo solo esta disponible en E. U. A."

ESTA GARANTÍA LIMITADA NO APLICA A:

- Viajes de servicio de mantenimiento a su casa para entregar, recoger y/o instalar el producto, dar instrucción, o para reemplazar fusibles de la casa o para corregir el alambrado eléctrico, ni para la corrección de reparaciones no autorizadas.
- Daños y perjuicios o problemas de funcionamiento que resulten por uso indebido o abuso, por operación fuera de las especificaciones ambientales o en contra de los requisitos de precauciones de la Guía de operación, por accidente, animales dañinos, incendio, inundación, instalación defectuosa, por fuerza mayor, modificación o alteración no autorizada, corriente eléctrica o voltaje incorrecto, uso comercial, o por uso diferente a los fines previstos.
- Reparaciones, cuando su refrigerador LG no es utilizado normalmente en la casa de una sola familia.

Los costos de reparación o reemplazo bajo estas circunstancias excluidas serán la responsabilidad del consumidor.

NÚMEROS DEL CENTRO INTERACTIVO DE ATENCIÓN AL CLIENTE

<p>Para obtener Asistencia al cliente, Información sobre productos, o sobre Ubicación de Distribuidores o de Centros de servicio autorizados:</p>	<p>Llame al 1-800-243-0000 (24 horas al día, 365 días al año) y escoja la opción apropiada del menú.</p> <p>O visite nuestro sitio Web en: http://www.lgservice.com</p>
--	--

PARA PONERSE EN CONTACTO POR CORREO CON LG ELECTRONICS:

LG Customer Interactive Center
P. O. Box 240007
201 James Record Road
Huntsville, Alabama 35824
ATTN: CIC

Below zip code list does not include "the zip code of Not Covered"

Zip Code	Coverage Level	Zip Code	Coverage Level	Zip Code	Coverage Level	Zip Code	Coverage Level	Zip Code	Coverage Level	Zip Code	Coverage Level
00027	Full Covered	00754	Full Covered	00984	Full Covered	01503	Full Covered	01776	Full Covered	01970	Full Covered
00042	Mostly Covered	00757	Full Covered	00985	Full Covered	01504	Full Covered	01778	Full Covered	01971	Full Covered
00063	Mostly Covered	00766	Full Covered	00986	Full Covered	01505	Full Covered	01784	Full Covered	01982	Full Covered
00083	Full Covered	00767	Full Covered	00987	Full Covered	01507	Mostly Covered	01801	Full Covered	01983	Full Covered
00084	Mostly Covered	00769	Full Covered	00988	Full Covered	01508	Mostly Covered	01803	Full Covered	01984	Full Covered
00157	Full Covered	00771	Full Covered	01001	Full Covered	01509	Mostly Covered	01805	Full Covered	01985	Full Covered
00501	Full Covered	00772	Mostly Covered	01003	Mostly Covered	01510	Full Covered	01806	Full Covered	02018	Full Covered
00544	Full Covered	00773	Full Covered	01004	Mostly Covered	01515	Mostly Covered	01807	Full Covered	02019	Full Covered
00601	Full Covered	00777	Full Covered	01012	Mostly Covered	01517	Full Covered	01808	Full Covered	02020	Mostly Covered
00602	Full Covered	00778	Full Covered	01013	Full Covered	01519	Mostly Covered	01810	Full Covered	02021	Full Covered
00603	Mostly Covered	00780	Full Covered	01014	Full Covered	01520	Full Covered	01812	Full Covered	02025	Full Covered
00604	Full Covered	00782	Full Covered	01020	Full Covered	01522	Full Covered	01813	Full Covered	02026	Full Covered
00605	Mostly Covered	00783	Mostly Covered	01021	Full Covered	01523	Full Covered	01815	Full Covered	02027	Full Covered
00606	Full Covered	00784	Mostly Covered	01022	Full Covered	01524	Full Covered	01821	Full Covered	02030	Full Covered
00610	Full Covered	00785	Mostly Covered	01027	Full Covered	01526	Mostly Covered	01822	Full Covered	02032	Full Covered
00612	Full Covered	00786	Mostly Covered	01028	Full Covered	01527	Full Covered	01824	Full Covered	02035	Full Covered
00613	Full Covered	00791	Full Covered	01030	Full Covered	01529	Mostly Covered	01826	Full Covered	02038	Full Covered
00614	Full Covered	00792	Full Covered	01032	Mostly Covered	01532	Full Covered	01827	Mostly Covered	02040	Mostly Covered
00616	Full Covered	00794	Mostly Covered	01033	Mostly Covered	01534	Mostly Covered	01830	Mostly Covered	02041	Mostly Covered
00617	Full Covered	00795	Full Covered	01035	Full Covered	01536	Full Covered	01831	Mostly Covered	02043	Full Covered
00622	Mostly Covered	00901	Full Covered	01036	Mostly Covered	01537	Mostly Covered	01832	Mostly Covered	02044	Full Covered
00624	Full Covered	00902	Full Covered	01038	Full Covered	01540	Mostly Covered	01833	Full Covered	02045	Full Covered
00627	Full Covered	00906	Full Covered	01039	Full Covered	01541	Full Covered	01834	Mostly Covered	02048	Full Covered
00631	Mostly Covered	00907	Full Covered	01040	Mostly Covered	01542	Full Covered	01835	Mostly Covered	02050	Mostly Covered
00636	Mostly Covered	00908	Full Covered	01041	Full Covered	01543	Full Covered	01840	Full Covered	02051	Mostly Covered
00637	Full Covered	00909	Full Covered	01053	Full Covered	01545	Full Covered	01841	Full Covered	02052	Full Covered
00638	Mostly Covered	00910	Full Covered	01056	Mostly Covered	01546	Full Covered	01842	Full Covered	02053	Full Covered
00646	Mostly Covered	00911	Full Covered	01059	Mostly Covered	01560	Mostly Covered	01843	Full Covered	02054	Full Covered
00647	Mostly Covered	00912	Full Covered	01060	Full Covered	01561	Full Covered	01844	Full Covered	02055	Full Covered
00650	Full Covered	00913	Full Covered	01061	Full Covered	01562	Full Covered	01845	Mostly Covered	02056	Full Covered
00652	Full Covered	00914	Full Covered	01062	Full Covered	01564	Full Covered	01850	Full Covered	02059	Mostly Covered
00653	Mostly Covered	00915	Full Covered	01063	Full Covered	01568	Full Covered	01851	Mostly Covered	02060	Full Covered
00656	Full Covered	00916	Full Covered	01066	Full Covered	01580	Full Covered	01852	Full Covered	02061	Full Covered
00659	Full Covered	00917	Full Covered	01068	Mostly Covered	01581	Full Covered	01853	Full Covered	02062	Full Covered
00660	Mostly Covered	00918	Full Covered	01073	Mostly Covered	01582	Full Covered	01854	Full Covered	02065	Mostly Covered
00667	Mostly Covered	00919	Full Covered	01075	Mostly Covered	01583	Full Covered	01860	Full Covered	02066	Full Covered
00670	Full Covered	00920	Full Covered	01085	Mostly Covered	01586	Full Covered	01862	Full Covered	02067	Full Covered
00674	Full Covered	00921	Full Covered	01086	Mostly Covered	01590	Mostly Covered	01863	Full Covered	02070	Full Covered
00676	Full Covered	00922	Full Covered	01088	Full Covered	01601	Full Covered	01864	Full Covered	02071	Full Covered
00677	Full Covered	00923	Full Covered	01089	Full Covered	01602	Full Covered	01865	Full Covered	02072	Full Covered
00678	Mostly Covered	00924	Full Covered	01090	Full Covered	01603	Full Covered	01866	Full Covered	02081	Full Covered
00680	Mostly Covered	00925	Full Covered	01093	Full Covered	01604	Full Covered	01867	Full Covered	02090	Full Covered
00681	Mostly Covered	00926	Full Covered	01095	Mostly Covered	01605	Full Covered	01876	Full Covered	02093	Full Covered
00682	Full Covered	00927	Full Covered	01096	Full Covered	01606	Full Covered	01879	Full Covered	02101	Full Covered
00683	Full Covered	00928	Full Covered	01101	Full Covered	01607	Full Covered	01880	Full Covered	02102	Full Covered
00685	Mostly Covered	00929	Full Covered	01102	Full Covered	01608	Full Covered	01885	Mostly Covered	02103	Full Covered
00687	Mostly Covered	00930	Full Covered	01103	Full Covered	01609	Full Covered	01886	Full Covered	02104	Full Covered
00688	Full Covered	00931	Full Covered	01104	Full Covered	01610	Full Covered	01887	Full Covered	02105	Full Covered
00692	Full Covered	00933	Full Covered	01105	Full Covered	01611	Full Covered	01888	Full Covered	02106	Full Covered
00693	Full Covered	00934	Full Covered	01106	Full Covered	01612	Full Covered	01889	Full Covered	02107	Full Covered
00694	Full Covered	00935	Full Covered	01107	Full Covered	01613	Full Covered	01890	Full Covered	02108	Full Covered
00698	Full Covered	00936	Full Covered	01108	Full Covered	01614	Full Covered	01899	Full Covered	02109	Full Covered
00703	Full Covered	00937	Full Covered	01109	Full Covered	01615	Full Covered	01901	Full Covered	02110	Full Covered
00705	Mostly Covered	00939	Full Covered	01111	Full Covered	01653	Full Covered	01902	Full Covered	02111	Full Covered
00707	Mostly Covered	00940	Full Covered	01114	Full Covered	01654	Full Covered	01903	Full Covered	02112	Full Covered
00714	Mostly Covered	00949	Mostly Covered	01115	Full Covered	01655	Full Covered	01904	Full Covered	02113	Full Covered
00715	Full Covered	00950	Mostly Covered	01116	Full Covered	01701	Full Covered	01905	Full Covered	02114	Full Covered
00716	Full Covered	00951	Mostly Covered	01118	Full Covered	01702	Full Covered	01906	Full Covered	02115	Full Covered
00717	Full Covered	00952	Full Covered	01119	Full Covered	01703	Full Covered	01907	Full Covered	02116	Full Covered
00718	Full Covered	00953	Full Covered	01128	Full Covered	01704	Full Covered	01908	Full Covered	02117	Full Covered
00719	Full Covered	00954	Full Covered	01129	Full Covered	01705	Full Covered	01910	Full Covered	02118	Full Covered
00720	Mostly Covered	00955	Full Covered	01133	Full Covered	01718	Full Covered	01913	Full Covered	02119	Full Covered
00721	Full Covered	00956	Full Covered	01138	Full Covered	01719	Full Covered	01915	Full Covered	02120	Full Covered
00723	Mostly Covered	00957	Full Covered	01139	Full Covered	01720	Full Covered	01921	Full Covered	02121	Full Covered
00725	Full Covered	00958	Full Covered	01144	Full Covered	01721	Full Covered	01922	Full Covered	02122	Full Covered
00726	Full Covered	00959	Full Covered	01151	Full Covered	01730	Full Covered	01923	Full Covered	02123	Full Covered
00727	Full Covered	00960	Full Covered	01152	Full Covered	01731	Full Covered	01929	Full Covered	02124	Full Covered
00728	Full Covered	00961	Full Covered	01199	Full Covered	01740	Full Covered	01930	Full Covered	02125	Full Covered
00729	Full Covered	00962	Full Covered	01341	Mostly Covered	01741	Full Covered	01931	Full Covered	02126	Full Covered
00730	Full Covered	00963	Full Covered	01373	Full Covered	01742	Full Covered	01936	Full Covered	02127	Full Covered
00731	Full Covered	00965	Full Covered	01375	Mostly Covered	01745	Full Covered	01937	Full Covered	02128	Full Covered
00732	Full Covered	00966	Full Covered	01420	Full Covered	01746	Full Covered	01938	Full Covered	02129	Full Covered
00733	Full Covered	00968	Full Covered	01432	Full Covered	01747	Mostly Covered	01940	Full Covered	02130	Full Covered
00734	Full Covered	00969	Full Covered	01450	Mostly Covered	01748	Full Covered	01944	Full Covered	02131	Full Covered
00735	Full Covered	00970	Full Covered	01451	Full Covered	01749	Full Covered	01945	Mostly Covered	02132	Full Covered
00736	Full Covered	00971	Full Covered	01453	Full Covered	01752	Full Covered	01949	Full Covered	02133	Full Covered
00737	Full Covered	00975	Full Covered	01460	Full Covered	01754	Full Covered	01950	Full Covered	02134	Full Covered
00738	Full Covered	00976	Full Covered	01462	Mostly Covered	01756	Mostly Covered	01951	Full Covered	02135	Full Covered
00739	Full Covered	00977	Full Covered	01464	Mostly Covered	01757	Mostly Covered	01952	Full Covered	02136	Full Covered
00740	Full Covered	00978	Full Covered	01467	Full Covered	01760	Full Covered	01960	Full Covered	02137	Full Covered
00741	Full Covered	00979	Full Covered	01471	Mostly Covered	01770	Full Covered	01961	Full Covered	02138	Full Covered
00742	Full Covered	00981	Full Covered	01472	Mostly Covered	01772	Full Covered	01965	Full Covered	02139	Full Covered
00744	Full Covered	00982	Full Covered	01473	Mostly Covered	01773	Full Covered	01966	Mostly Covered	02140	Full Covered
00745	Full Covered	00983	Full Covered	01501	Full Covered	01775	Full Covered	01969	Full Covered	02141	Full Covered

Zip Code	Coverage Level	Zip Code	Coverage Level	Zip Code	Coverage Level	Zip Code	Coverage Level	Zip Code	Coverage Level	Zip Code	Coverage Level
02142	Full Covered	02360	Full Covered	02646	Full Covered	02841	Full Covered	03258	Full Covered	04062	Full Covered
02143	Full Covered	02361	Full Covered	02647	Full Covered	02842	Full Covered	03263	Mostly Covered	04063	Full Covered
02144	Full Covered	02362	Full Covered	02648	Full Covered	02852	Mostly Covered	03275	Full Covered	04064	Full Covered
02145	Full Covered	02364	Full Covered	02649	Mostly Covered	02857	Full Covered	03281	Mostly Covered	04066	Mostly Covered
02148	Full Covered	02366	Full Covered	02650	Full Covered	02860	Full Covered	03301	Full Covered	04069	Mostly Covered
02149	Full Covered	02367	Full Covered	02651	Full Covered	02861	Full Covered	03302	Full Covered	04070	Full Covered
02150	Full Covered	02368	Full Covered	02653	Full Covered	02862	Full Covered	03304	Mostly Covered	04072	Full Covered
02151	Full Covered	02370	Full Covered	02655	Full Covered	02863	Full Covered	03307	Full Covered	04073	Full Covered
02152	Full Covered	02375	Mostly Covered	02659	Full Covered	02864	Full Covered	03801	Full Covered	04074	Full Covered
02153	Full Covered	02379	Full Covered	02660	Mostly Covered	02865	Full Covered	03802	Full Covered	04076	Mostly Covered
02155	Full Covered	02381	Mostly Covered	02661	Full Covered	02871	Full Covered	03804	Full Covered	04078	Full Covered
02156	Full Covered	02382	Full Covered	02662	Full Covered	02872	Full Covered	03805	Full Covered	04079	Mostly Covered
02163	Full Covered	02420	Full Covered	02663	Mostly Covered	02873	Mostly Covered	03809	Full Covered	04082	Full Covered
02169	Full Covered	02421	Full Covered	02664	Mostly Covered	02876	Mostly Covered	03810	Full Covered	04083	Full Covered
02170	Full Covered	02445	Full Covered	02667	Mostly Covered	02878	Mostly Covered	03811	Full Covered	04086	Full Covered
02171	Full Covered	02446	Full Covered	02668	Full Covered	02885	Mostly Covered	03815	Mostly Covered	04087	Mostly Covered
02176	Full Covered	02447	Full Covered	02669	Full Covered	02886	Mostly Covered	03819	Mostly Covered	04092	Full Covered
02180	Full Covered	02451	Full Covered	02670	Mostly Covered	02887	Full Covered	03820	Full Covered	04093	Mostly Covered
02184	Full Covered	02452	Full Covered	02671	Mostly Covered	02888	Full Covered	03821	Full Covered	04096	Mostly Covered
02185	Full Covered	02453	Full Covered	02672	Full Covered	02889	Full Covered	03822	Full Covered	04097	Mostly Covered
02186	Full Covered	02454	Full Covered	02673	Full Covered	02891	Mostly Covered	03824	Full Covered	04098	Full Covered
02187	Full Covered	02455	Full Covered	02675	Full Covered	02893	Full Covered	03825	Mostly Covered	04101	Full Covered
02188	Full Covered	02456	Full Covered	02702	Full Covered	02895	Full Covered	03826	Mostly Covered	04102	Full Covered
02189	Full Covered	02457	Full Covered	02703	Mostly Covered	02896	Full Covered	03827	Full Covered	04103	Full Covered
02190	Full Covered	02458	Full Covered	02712	Full Covered	02901	Full Covered	03833	Full Covered	04104	Full Covered
02191	Full Covered	02459	Full Covered	02714	Full Covered	02902	Full Covered	03835	Mostly Covered	04105	Full Covered
02196	Full Covered	02460	Full Covered	02715	Full Covered	02903	Full Covered	03837	Mostly Covered	04106	Full Covered
02199	Full Covered	02461	Full Covered	02717	Full Covered	02904	Full Covered	03839	Mostly Covered	04107	Mostly Covered
02201	Full Covered	02462	Full Covered	02718	Mostly Covered	02905	Full Covered	03840	Full Covered	04108	Mostly Covered
02203	Full Covered	02464	Full Covered	02719	Full Covered	02906	Full Covered	03841	Full Covered	04109	Mostly Covered
02204	Full Covered	02465	Full Covered	02720	Full Covered	02907	Full Covered	03842	Full Covered	04110	Mostly Covered
02205	Full Covered	02466	Full Covered	02721	Full Covered	02908	Full Covered	03843	Full Covered	04112	Full Covered
02206	Full Covered	02467	Full Covered	02722	Full Covered	02909	Full Covered	03844	Full Covered	04116	Full Covered
02207	Full Covered	02468	Full Covered	02723	Full Covered	02910	Full Covered	03848	Mostly Covered	04122	Full Covered
02208	Full Covered	02471	Full Covered	02724	Mostly Covered	02911	Full Covered	03851	Mostly Covered	04123	Full Covered
02209	Full Covered	02472	Full Covered	02725	Full Covered	02912	Full Covered	03854	Full Covered	04124	Full Covered
02210	Full Covered	02474	Full Covered	02726	Full Covered	02914	Full Covered	03855	Full Covered	04222	Full Covered
02211	Full Covered	02475	Full Covered	02738	Mostly Covered	02915	Full Covered	03856	Full Covered	04250	Mostly Covered
02212	Full Covered	02476	Full Covered	02739	Full Covered	02916	Full Covered	03857	Full Covered	04252	Mostly Covered
02215	Full Covered	02477	Full Covered	02740	Full Covered	02917	Full Covered	03858	Full Covered	04287	Mostly Covered
02216	Full Covered	02478	Full Covered	02741	Full Covered	02918	Full Covered	03859	Mostly Covered	04330	Full Covered
02217	Full Covered	02479	Full Covered	02742	Full Covered	02919	Full Covered	03862	Full Covered	04332	Full Covered
02222	Full Covered	02481	Full Covered	02743	Full Covered	02920	Full Covered	03865	Mostly Covered	04333	Full Covered
02228	Full Covered	02482	Full Covered	02744	Full Covered	02921	Full Covered	03866	Mostly Covered	04336	Full Covered
02238	Full Covered	02492	Full Covered	02745	Full Covered	02940	Full Covered	03867	Mostly Covered	04338	Full Covered
02239	Full Covered	02493	Full Covered	02746	Full Covered	03031	Full Covered	03868	Mostly Covered	04343	Full Covered
02241	Full Covered	02494	Full Covered	02747	Full Covered	03032	Full Covered	03869	Full Covered	04344	Full Covered
02266	Full Covered	02495	Full Covered	02748	Full Covered	03034	Mostly Covered	03870	Full Covered	04345	Full Covered
02269	Full Covered	02532	Mostly Covered	02760	Full Covered	03036	Full Covered	03871	Full Covered	04346	Mostly Covered
02283	Full Covered	02534	Full Covered	02761	Full Covered	03038	Full Covered	03873	Full Covered	04347	Full Covered
02284	Full Covered	02536	Full Covered	02762	Mostly Covered	03040	Full Covered	03874	Full Covered	04350	Mostly Covered
02293	Full Covered	02537	Full Covered	02763	Mostly Covered	03041	Full Covered	03878	Full Covered	04351	Full Covered
02295	Full Covered	02539	Mostly Covered	02764	Full Covered	03044	Mostly Covered	03884	Mostly Covered	04355	Mostly Covered
02297	Full Covered	02540	Full Covered	02766	Full Covered	03045	Full Covered	03885	Full Covered	04357	Mostly Covered
02301	Full Covered	02541	Full Covered	02767	Mostly Covered	03046	Full Covered	03887	Mostly Covered	04359	Mostly Covered
02302	Full Covered	02542	Full Covered	02768	Mostly Covered	03051	Full Covered	03901	Full Covered	04364	Mostly Covered
02303	Full Covered	02543	Full Covered	02769	Full Covered	03052	Mostly Covered	03903	Full Covered	04917	Mostly Covered
02304	Full Covered	02553	Mostly Covered	02770	Mostly Covered	03053	Mostly Covered	03904	Full Covered	05501	Full Covered
02305	Full Covered	02556	Full Covered	02771	Full Covered	03054	Mostly Covered	03905	Full Covered	05544	Full Covered
02322	Full Covered	02557	Full Covered	02777	Mostly Covered	03057	Full Covered	03906	Full Covered	06001	Full Covered
02324	Mostly Covered	02559	Mostly Covered	02779	Full Covered	03060	Full Covered	03908	Mostly Covered	06002	Full Covered
02325	Mostly Covered	02563	Mostly Covered	02780	Full Covered	03061	Full Covered	03909	Mostly Covered	06006	Mostly Covered
02327	Mostly Covered	02565	Full Covered	02783	Full Covered	03062	Full Covered	03910	Mostly Covered	06010	Full Covered
02330	Full Covered	02568	Mostly Covered	02790	Full Covered	03063	Mostly Covered	03911	Mostly Covered	06011	Full Covered
02331	Full Covered	02571	Mostly Covered	02801	Mostly Covered	03064	Full Covered	04001	Mostly Covered	06013	Mostly Covered
02332	Full Covered	02573	Full Covered	02802	Full Covered	03070	Full Covered	04002	Mostly Covered	06016	Mostly Covered
02333	Full Covered	02574	Full Covered	02804	Mostly Covered	03073	Full Covered	04003	Mostly Covered	06019	Mostly Covered
02334	Full Covered	02575	Mostly Covered	02806	Mostly Covered	03076	Full Covered	04004	Mostly Covered	06020	Mostly Covered
02337	Full Covered	02576	Mostly Covered	02809	Mostly Covered	03077	Full Covered	04005	Full Covered	06022	Mostly Covered
02338	Mostly Covered	02601	Full Covered	02815	Mostly Covered	03079	Full Covered	04006	Full Covered	06023	Full Covered
02339	Full Covered	02630	Full Covered	02816	Mostly Covered	03087	Full Covered	04007	Full Covered	06025	Full Covered
02340	Mostly Covered	02631	Full Covered	02818	Mostly Covered	03101	Full Covered	04011	Full Covered	06028	Mostly Covered
02341	Mostly Covered	02632	Full Covered	02823	Full Covered	03102	Full Covered	04013	Full Covered	06029	Full Covered
02343	Full Covered	02633	Full Covered	02824	Full Covered	03103	Mostly Covered	04014	Mostly Covered	06030	Full Covered
02345	Mostly Covered	02634	Full Covered	02825	Mostly Covered	03104	Mostly Covered	04021	Full Covered	06032	Full Covered
02346	Mostly Covered	02635	Full Covered	02828	Full Covered	03105	Mostly Covered	04027	Full Covered	06033	Full Covered
02347	Mostly Covered	02637	Full Covered	02829	Full Covered	03106	Mostly Covered	04032	Full Covered	06034	Full Covered
02350	Mostly Covered	02638	Mostly Covered	02831	Full Covered	03108	Mostly Covered	04033	Full Covered	06037	Full Covered
02351	Full Covered	02639	Mostly Covered	02833	Mostly Covered	03109	Mostly Covered	04034	Full Covered	06040	Full Covered
02355	Full Covered	02641	Mostly Covered	02835	Full Covered	03110	Full Covered	04038	Mostly Covered	06041	Full Covered
02356	Full Covered	02642	Full Covered	02837	Mostly Covered	03218	Full Covered	04039	Mostly Covered	06043	Full Covered
02357	Full Covered	02643	Full Covered	02838	Full Covered	03224	Mostly Covered	04046	Mostly Covered	06045	Full Covered
02358	Mostly Covered	02644	Mostly Covered	02839	Mostly Covered	03225	Full Covered	04050	Mostly Covered	06050	Full Covered
02359	Mostly Covered	02645	Full Covered	02840	Full Covered	03234	Full Covered	04053	Full Covered	06051	Full Covered

Zip Code	Coverage Level	Zip Code	Coverage Level	Zip Code	Coverage Level	Zip Code	Coverage Level	Zip Code	Coverage Level	Zip Code	Coverage Level
07501	Full Covered	07731	Full Covered	07931	Full Covered	08078	Full Covered	08362	Mostly Covered	08753	Full Covered
07502	Full Covered	07732	Mostly Covered	07932	Full Covered	08080	Full Covered	08401	Full Covered	08754	Full Covered
07503	Full Covered	07733	Full Covered	07933	Full Covered	08081	Full Covered	08402	Full Covered	08755	Full Covered
07504	Full Covered	07734	Full Covered	07934	Full Covered	08083	Full Covered	08403	Full Covered	08756	Full Covered
07505	Full Covered	07735	Full Covered	07935	Full Covered	08084	Full Covered	08404	Full Covered	08757	Full Covered
07506	Full Covered	07737	Full Covered	07936	Full Covered	08085	Full Covered	08406	Full Covered	08758	Mostly Covered
07507	Full Covered	07738	Full Covered	07938	Full Covered	08086	Full Covered	08502	Full Covered	08759	Mostly Covered
07508	Full Covered	07739	Full Covered	07939	Full Covered	08089	Full Covered	08504	Full Covered	08801	Full Covered
07509	Full Covered	07740	Full Covered	07940	Full Covered	08090	Full Covered	08505	Full Covered	08802	Mostly Covered
07510	Full Covered	07746	Full Covered	07945	Full Covered	08091	Full Covered	08512	Full Covered	08803	Full Covered
07511	Full Covered	07747	Full Covered	07946	Full Covered	08093	Full Covered	08515	Mostly Covered	08805	Full Covered
07512	Full Covered	07748	Full Covered	07950	Full Covered	08094	Full Covered	08518	Full Covered	08807	Full Covered
07513	Full Covered	07750	Full Covered	07960	Full Covered	08095	Full Covered	08520	Full Covered	08809	Full Covered
07514	Full Covered	07751	Full Covered	07961	Full Covered	08096	Full Covered	08525	Mostly Covered	08810	Full Covered
07522	Full Covered	07752	Mostly Covered	07962	Full Covered	08097	Full Covered	08527	Mostly Covered	08812	Full Covered
07524	Full Covered	07753	Full Covered	07963	Full Covered	08098	Full Covered	08528	Full Covered	08816	Full Covered
07533	Full Covered	07754	Full Covered	07970	Full Covered	08099	Full Covered	08530	Mostly Covered	08817	Full Covered
07538	Full Covered	07755	Full Covered	07974	Full Covered	08101	Full Covered	08534	Mostly Covered	08818	Full Covered
07543	Full Covered	07756	Full Covered	07976	Full Covered	08102	Full Covered	08536	Full Covered	08820	Full Covered
07544	Full Covered	07757	Full Covered	07977	Full Covered	08103	Full Covered	08540	Full Covered	08821	Mostly Covered
07601	Full Covered	07758	Full Covered	07978	Full Covered	08104	Full Covered	08541	Full Covered	08822	Full Covered
07602	Full Covered	07760	Mostly Covered	07979	Mostly Covered	08105	Full Covered	08542	Full Covered	08823	Full Covered
07603	Full Covered	07762	Mostly Covered	07980	Full Covered	08106	Full Covered	08543	Full Covered	08824	Full Covered
07604	Full Covered	07763	Mostly Covered	07981	Full Covered	08107	Full Covered	08544	Full Covered	08825	Mostly Covered
07605	Full Covered	07764	Full Covered	07983	Full Covered	08108	Full Covered	08550	Full Covered	08826	Mostly Covered
07606	Full Covered	07765	Full Covered	07989	Full Covered	08109	Full Covered	08551	Mostly Covered	08827	Mostly Covered
07607	Full Covered	07777	Full Covered	08001	Mostly Covered	08110	Full Covered	08553	Full Covered	08828	Full Covered
07608	Full Covered	07799	Full Covered	08002	Full Covered	08201	Full Covered	08554	Full Covered	08829	Full Covered
07620	Full Covered	07801	Full Covered	08003	Full Covered	08202	Mostly Covered	08555	Mostly Covered	08830	Full Covered
07621	Full Covered	07802	Full Covered	08004	Full Covered	08203	Full Covered	08556	Mostly Covered	08831	Mostly Covered
07624	Full Covered	07803	Full Covered	08007	Full Covered	08204	Full Covered	08557	Full Covered	08832	Full Covered
07626	Full Covered	07806	Full Covered	08009	Full Covered	08205	Mostly Covered	08558	Full Covered	08833	Full Covered
07627	Full Covered	07820	Full Covered	08010	Full Covered	08210	Full Covered	08559	Mostly Covered	08834	Mostly Covered
07628	Full Covered	07821	Full Covered	08012	Full Covered	08212	Mostly Covered	08560	Mostly Covered	08835	Full Covered
07630	Full Covered	07822	Full Covered	08014	Mostly Covered	08213	Full Covered	08561	Full Covered	08836	Full Covered
07631	Full Covered	07826	Mostly Covered	08016	Full Covered	08214	Mostly Covered	08570	Full Covered	08837	Full Covered
07632	Full Covered	07828	Full Covered	08018	Full Covered	08215	Full Covered	08601	Full Covered	08840	Full Covered
07640	Full Covered	07830	Mostly Covered	08020	Full Covered	08217	Full Covered	08602	Full Covered	08844	Mostly Covered
07641	Full Covered	07834	Full Covered	08021	Full Covered	08218	Full Covered	08603	Full Covered	08846	Full Covered
07642	Full Covered	07836	Full Covered	08022	Mostly Covered	08219	Full Covered	08604	Full Covered	08850	Full Covered
07643	Full Covered	07837	Full Covered	08023	Full Covered	08220	Mostly Covered	08605	Full Covered	08852	Full Covered
07644	Full Covered	07838	Mostly Covered	08025	Full Covered	08221	Mostly Covered	08606	Full Covered	08853	Mostly Covered
07645	Full Covered	07839	Full Covered	08026	Full Covered	08223	Full Covered	08607	Full Covered	08854	Full Covered
07646	Full Covered	07840	Full Covered	08027	Full Covered	08225	Mostly Covered	08608	Full Covered	08855	Full Covered
07647	Full Covered	07842	Full Covered	08028	Full Covered	08226	Full Covered	08609	Full Covered	08857	Full Covered
07648	Full Covered	07843	Full Covered	08029	Full Covered	08230	Full Covered	08610	Full Covered	08858	Mostly Covered
07649	Full Covered	07845	Full Covered	08030	Full Covered	08231	Full Covered	08611	Full Covered	08859	Full Covered
07650	Full Covered	07846	Mostly Covered	08031	Full Covered	08232	Full Covered	08618	Full Covered	08861	Full Covered
07652	Full Covered	07847	Full Covered	08032	Full Covered	08234	Mostly Covered	08619	Full Covered	08862	Full Covered
07653	Full Covered	07848	Full Covered	08033	Full Covered	08240	Full Covered	08620	Mostly Covered	08863	Full Covered
07656	Full Covered	07849	Full Covered	08034	Full Covered	08241	Mostly Covered	08625	Full Covered	08867	Full Covered
07657	Full Covered	07850	Full Covered	08035	Full Covered	08242	Full Covered	08628	Full Covered	08868	Full Covered
07660	Full Covered	07851	Mostly Covered	08036	Full Covered	08243	Full Covered	08629	Full Covered	08869	Full Covered
07661	Full Covered	07852	Full Covered	08037	Mostly Covered	08244	Mostly Covered	08638	Full Covered	08870	Mostly Covered
07662	Full Covered	07853	Full Covered	08039	Full Covered	08245	Mostly Covered	08645	Full Covered	08871	Full Covered
07663	Full Covered	07855	Full Covered	08043	Full Covered	08246	Full Covered	08646	Full Covered	08872	Full Covered
07666	Full Covered	07856	Full Covered	08045	Full Covered	08247	Full Covered	08647	Full Covered	08873	Full Covered
07670	Full Covered	07857	Full Covered	08046	Full Covered	08248	Full Covered	08648	Full Covered	08875	Full Covered
07675	Full Covered	07860	Full Covered	08048	Full Covered	08250	Mostly Covered	08650	Full Covered	08876	Full Covered
07676	Full Covered	07865	Mostly Covered	08049	Full Covered	08251	Full Covered	08666	Full Covered	08878	Full Covered
07677	Full Covered	07866	Full Covered	08051	Full Covered	08252	Full Covered	08677	Full Covered	08879	Full Covered
07699	Full Covered	07869	Full Covered	08052	Full Covered	08260	Full Covered	08690	Full Covered	08880	Full Covered
07701	Full Covered	07870	Full Covered	08053	Full Covered	08270	Mostly Covered	08691	Mostly Covered	08882	Full Covered
07702	Full Covered	07871	Full Covered	08054	Full Covered	08310	Full Covered	08695	Full Covered	08884	Full Covered
07703	Full Covered	07874	Full Covered	08055	Mostly Covered	08312	Full Covered	08701	Full Covered	08885	Full Covered
07704	Full Covered	07875	Full Covered	08056	Full Covered	08313	Mostly Covered	08720	Mostly Covered	08887	Mostly Covered
07709	Full Covered	07876	Full Covered	08057	Full Covered	08317	Full Covered	08721	Full Covered	08888	Mostly Covered
07710	Full Covered	07877	Full Covered	08059	Full Covered	08318	Mostly Covered	08722	Full Covered	08889	Mostly Covered
07711	Full Covered	07878	Full Covered	08060	Mostly Covered	08319	Full Covered	08723	Full Covered	08890	Full Covered
07712	Full Covered	07879	Full Covered	08061	Full Covered	08322	Full Covered	08724	Full Covered	08896	Full Covered
07715	Full Covered	07880	Full Covered	08062	Full Covered	08326	Full Covered	08730	Mostly Covered	08899	Full Covered
07716	Mostly Covered	07881	Mostly Covered	08063	Full Covered	08328	Full Covered	08731	Full Covered	08901	Full Covered
07717	Full Covered	07885	Full Covered	08065	Full Covered	08330	Mostly Covered	08732	Full Covered	08902	Full Covered
07718	Full Covered	07890	Mostly Covered	08066	Full Covered	08332	Mostly Covered	08734	Full Covered	08903	Full Covered
07719	Full Covered	07901	Full Covered	08067	Mostly Covered	08340	Full Covered	08735	Mostly Covered	08904	Full Covered
07720	Full Covered	07902	Full Covered	08069	Full Covered	08341	Full Covered	08736	Mostly Covered	08905	Full Covered
07721	Full Covered	07920	Full Covered	08070	Full Covered	08342	Full Covered	08738	Mostly Covered	08906	Full Covered
07722	Full Covered	07921	Full Covered	08071	Full Covered	08343	Mostly Covered	08739	Mostly Covered	08922	Full Covered
07723	Full Covered	07922	Full Covered	08072	Mostly Covered	08344	Full Covered	08740	Full Covered	08933	Full Covered
07724	Full Covered	07924	Full Covered	08073	Full Covered	08346	Mostly Covered	08741	Full Covered	08988	Full Covered
07726	Mostly Covered	07926	Full Covered	08074	Full Covered	08348	Mostly Covered	08742	Mostly Covered	08989	Full Covered
07727	Full Covered	07927	Full Covered	08075	Full Covered	08350	Full Covered	08750	Mostly Covered	10001	Full Covered
07728	Full Covered	07928	Full Covered	08076	Full Covered	08360	Mostly Covered	08751	Full Covered	10002	Full Covered
07730	Full Covered	07930	Full Covered	08077	Full Covered	08361	Full Covered	08752	Mostly Covered	10003	Full Covered

Zip Code	Coverage Level	Zip Code	Coverage Level	Zip Code	Coverage Level	Zip Code	Coverage Level	Zip Code	Coverage Level	Zip Code	Coverage Level
11565	Full Covered	11762	Full Covered	11978	Full Covered	12210	Full Covered	12563	Full Covered	13134	Full Covered
11566	Full Covered	11763	Full Covered	11980	Full Covered	12211	Full Covered	12564	Full Covered	13135	Full Covered
11568	Full Covered	11764	Full Covered	12007	Full Covered	12212	Mostly Covered	12568	Mostly Covered	13137	Full Covered
11569	Full Covered	11765	Full Covered	12008	Full Covered	12220	Full Covered	12570	Full Covered	13138	Full Covered
11570	Full Covered	11766	Full Covered	12009	Full Covered	12222	Full Covered	12577	Mostly Covered	13140	Mostly Covered
11571	Full Covered	11767	Full Covered	12010	Mostly Covered	12223	Full Covered	12580	Mostly Covered	13141	Full Covered
11572	Full Covered	11768	Mostly Covered	12015	Mostly Covered	12224	Full Covered	12582	Full Covered	13152	Mostly Covered
11575	Full Covered	11769	Full Covered	12018	Mostly Covered	12225	Full Covered	12584	Full Covered	13153	Full Covered
11576	Full Covered	11770	Mostly Covered	12019	Full Covered	12226	Full Covered	12590	Mostly Covered	13159	Mostly Covered
11577	Full Covered	11771	Full Covered	12020	Full Covered	12227	Full Covered	12594	Mostly Covered	13160	Mostly Covered
11579	Full Covered	11772	Full Covered	12023	Mostly Covered	12228	Full Covered	12601	Full Covered	13162	Mostly Covered
11580	Full Covered	11773	Full Covered	12027	Full Covered	12229	Full Covered	12602	Full Covered	13163	Full Covered
11581	Full Covered	11774	Full Covered	12031	Mostly Covered	12230	Full Covered	12603	Mostly Covered	13164	Full Covered
11582	Full Covered	11775	Full Covered	12033	Full Covered	12231	Full Covered	12604	Full Covered	13166	Full Covered
11583	Full Covered	11776	Full Covered	12041	Full Covered	12232	Full Covered	12721	Mostly Covered	13201	Full Covered
11588	Full Covered	11777	Mostly Covered	12042	Full Covered	12233	Full Covered	12722	Mostly Covered	13202	Full Covered
11590	Full Covered	11778	Mostly Covered	12045	Full Covered	12234	Full Covered	12785	Mostly Covered	13203	Full Covered
11592	Full Covered	11779	Full Covered	12046	Full Covered	12235	Full Covered	12790	Mostly Covered	13204	Full Covered
11593	Mostly Covered	11780	Full Covered	12047	Mostly Covered	12236	Full Covered	12801	Full Covered	13205	Full Covered
11594	Full Covered	11782	Full Covered	12050	Mostly Covered	12237	Full Covered	12803	Full Covered	13206	Full Covered
11595	Full Covered	11783	Mostly Covered	12051	Mostly Covered	12238	Full Covered	12804	Full Covered	13207	Full Covered
11596	Full Covered	11784	Full Covered	12053	Mostly Covered	12239	Full Covered	12820	Mostly Covered	13208	Full Covered
11597	Full Covered	11786	Mostly Covered	12054	Full Covered	12240	Full Covered	12828	Mostly Covered	13209	Full Covered
11598	Full Covered	11787	Full Covered	12055	Full Covered	12241	Full Covered	12831	Full Covered	13210	Full Covered
11599	Full Covered	11788	Full Covered	12056	Full Covered	12242	Full Covered	12833	Mostly Covered	13211	Full Covered
11690	Full Covered	11789	Mostly Covered	12058	Mostly Covered	12243	Full Covered	12839	Mostly Covered	13212	Full Covered
11691	Full Covered	11790	Full Covered	12059	Full Covered	12244	Full Covered	12845	Mostly Covered	13214	Full Covered
11692	Full Covered	11791	Full Covered	12061	Full Covered	12245	Full Covered	12846	Mostly Covered	13215	Full Covered
11693	Full Covered	11792	Full Covered	12063	Full Covered	12246	Full Covered	12863	Mostly Covered	13217	Full Covered
11694	Full Covered	11793	Full Covered	12065	Full Covered	12247	Full Covered	12866	Full Covered	13218	Full Covered
11695	Full Covered	11794	Mostly Covered	12067	Full Covered	12248	Full Covered	12901	Mostly Covered	13219	Full Covered
11697	Full Covered	11795	Full Covered	12077	Full Covered	12249	Full Covered	12910	Full Covered	13220	Full Covered
11701	Full Covered	11796	Full Covered	12084	Mostly Covered	12250	Full Covered	12918	Full Covered	13221	Full Covered
11702	Mostly Covered	11797	Full Covered	12085	Full Covered	12252	Full Covered	12929	Full Covered	13224	Full Covered
11703	Full Covered	11798	Full Covered	12086	Mostly Covered	12255	Full Covered	12962	Full Covered	13225	Full Covered
11704	Full Covered	11801	Full Covered	12087	Full Covered	12256	Full Covered	12992	Full Covered	13235	Full Covered
11705	Full Covered	11802	Full Covered	12106	Mostly Covered	12257	Full Covered	13020	Mostly Covered	13244	Full Covered
11706	Full Covered	11803	Full Covered	12107	Full Covered	12260	Full Covered	13021	Full Covered	13250	Full Covered
11707	Full Covered	11804	Full Covered	12110	Mostly Covered	12261	Full Covered	13022	Full Covered	13251	Full Covered
11708	Full Covered	11805	Full Covered	12118	Full Covered	12288	Mostly Covered	13024	Full Covered	13252	Full Covered
11709	Full Covered	11815	Full Covered	12121	Mostly Covered	12301	Full Covered	13027	Full Covered	13261	Full Covered
11710	Full Covered	11819	Full Covered	12123	Mostly Covered	12302	Full Covered	13029	Full Covered	13290	Full Covered
11713	Full Covered	11854	Full Covered	12124	Full Covered	12303	Mostly Covered	13031	Full Covered	13303	Full Covered
11714	Full Covered	11855	Full Covered	12128	Full Covered	12304	Full Covered	13032	Full Covered	13304	Full Covered
11715	Full Covered	11901	Full Covered	12130	Mostly Covered	12305	Full Covered	13033	Mostly Covered	13309	Mostly Covered
11716	Full Covered	11931	Full Covered	12137	Full Covered	12306	Full Covered	13034	Mostly Covered	13310	Mostly Covered
11717	Full Covered	11932	Full Covered	12140	Full Covered	12307	Full Covered	13039	Mostly Covered	13317	Full Covered
11718	Full Covered	11933	Full Covered	12141	Mostly Covered	12308	Full Covered	13041	Full Covered	13319	Mostly Covered
11719	Mostly Covered	11934	Full Covered	12143	Full Covered	12309	Full Covered	13043	Full Covered	13320	Mostly Covered
11720	Full Covered	11935	Mostly Covered	12144	Full Covered	12325	Full Covered	13045	Full Covered	13322	Mostly Covered
11721	Mostly Covered	11937	Mostly Covered	12147	Mostly Covered	12345	Full Covered	13051	Mostly Covered	13339	Full Covered
11722	Full Covered	11939	Mostly Covered	12148	Full Covered	12411	Mostly Covered	13054	Mostly Covered	13340	Full Covered
11724	Full Covered	11940	Full Covered	12150	Full Covered	12419	Mostly Covered	13056	Full Covered	13350	Full Covered
11725	Full Covered	11941	Full Covered	12151	Full Covered	12429	Full Covered	13057	Full Covered	13354	Mostly Covered
11726	Full Covered	11942	Full Covered	12156	Full Covered	12440	Mostly Covered	13060	Full Covered	13357	Mostly Covered
11727	Full Covered	11944	Mostly Covered	12158	Full Covered	12466	Mostly Covered	13062	Mostly Covered	13361	Mostly Covered
11729	Full Covered	11946	Mostly Covered	12159	Mostly Covered	12471	Mostly Covered	13063	Full Covered	13362	Mostly Covered
11730	Full Covered	11947	Full Covered	12161	Full Covered	12472	Mostly Covered	13066	Full Covered	13363	Full Covered
11731	Full Covered	11948	Mostly Covered	12166	Mostly Covered	12486	Mostly Covered	13068	Mostly Covered	13365	Mostly Covered
11732	Full Covered	11949	Full Covered	12170	Mostly Covered	12487	Mostly Covered	13069	Full Covered	13403	Full Covered
11733	Mostly Covered	11950	Full Covered	12173	Full Covered	12493	Full Covered	13074	Full Covered	13406	Mostly Covered
11735	Full Covered	11951	Full Covered	12174	Mostly Covered	12508	Full Covered	13077	Full Covered	13407	Full Covered
11736	Full Covered	11952	Mostly Covered	12176	Mostly Covered	12511	Full Covered	13078	Full Covered	13408	Full Covered
11737	Full Covered	11953	Full Covered	12180	Full Covered	12512	Full Covered	13080	Full Covered	13409	Full Covered
11738	Full Covered	11955	Full Covered	12181	Full Covered	12515	Full Covered	13084	Full Covered	13410	Full Covered
11739	Full Covered	11956	Mostly Covered	12182	Mostly Covered	12518	Full Covered	13087	Full Covered	13413	Mostly Covered
11740	Full Covered	11958	Mostly Covered	12183	Full Covered	12520	Full Covered	13088	Full Covered	13417	Mostly Covered
11741	Full Covered	11959	Mostly Covered	12184	Mostly Covered	12524	Full Covered	13089	Full Covered	13421	Full Covered
11742	Full Covered	11960	Full Covered	12186	Full Covered	12527	Full Covered	13090	Full Covered	13428	Full Covered
11743	Full Covered	11961	Full Covered	12188	Mostly Covered	12528	Full Covered	13093	Mostly Covered	13431	Mostly Covered
11745	Full Covered	11962	Full Covered	12189	Full Covered	12531	Full Covered	13101	Mostly Covered	13435	Mostly Covered
11746	Full Covered	11963	Full Covered	12192	Full Covered	12533	Mostly Covered	13102	Mostly Covered	13439	Mostly Covered
11747	Full Covered	11964	Full Covered	12193	Full Covered	12537	Full Covered	13104	Full Covered	13440	Mostly Covered
11749	Full Covered	11965	Full Covered	12196	Full Covered	12538	Mostly Covered	13108	Mostly Covered	13441	Full Covered
11750	Full Covered	11967	Full Covered	12198	Full Covered	12540	Mostly Covered	13112	Full Covered	13442	Full Covered
11751	Full Covered	11968	Full Covered	12201	Mostly Covered	12542	Full Covered	13113	Mostly Covered	13452	Mostly Covered
11752	Full Covered	11969	Full Covered	12202	Full Covered	12547	Full Covered	13115	Full Covered	13456	Mostly Covered
11753	Full Covered	11970	Full Covered	12203	Full Covered	12548	Mostly Covered	13116	Mostly Covered	13459	Full Covered
11754	Full Covered	11971	Full Covered	12204	Full Covered	12550	Full Covered	13117	Mostly Covered	13461	Full Covered
11755	Full Covered	11972	Full Covered	12205	Full Covered	12551	Full Covered	13119	Full Covered	13468	Mostly Covered
11756	Full Covered	11973	Full Covered	12206	Full Covered	12552	Full Covered	13120	Full Covered	13469	Mostly Covered
11757	Full Covered	11975	Full Covered	12207	Full Covered	12553	Mostly Covered	13121	Mostly Covered	13475	Mostly Covered
11758	Full Covered	11976	Full Covered	12208	Full Covered	12555	Mostly Covered	13126	Full Covered	13476	Mostly Covered
11760	Full Covered	11977	Full Covered	12209	Full Covered	12561	Full Covered	13132	Mostly Covered	13477	Mostly Covered

Zip Code	Coverage Level	Zip Code	Coverage Level	Zip Code	Coverage Level	Zip Code	Coverage Level	Zip Code	Coverage Level	Zip Code	Coverage Level
13478	Mostly Covered	14085	Mostly Covered	14422	Mostly Covered	14612	Full Covered	15003	Full Covered	15127	Full Covered
13479	Mostly Covered	14086	Mostly Covered	14424	Full Covered	14613	Full Covered	15005	Full Covered	15129	Full Covered
13484	Mostly Covered	14092	Mostly Covered	14425	Full Covered	14614	Full Covered	15006	Full Covered	15130	Full Covered
13486	Full Covered	14094	Full Covered	14428	Mostly Covered	14615	Full Covered	15007	Full Covered	15131	Full Covered
13489	Mostly Covered	14095	Full Covered	14429	Mostly Covered	14616	Full Covered	15009	Full Covered	15132	Full Covered
13492	Mostly Covered	14102	Full Covered	14430	Full Covered	14617	Full Covered	15010	Mostly Covered	15133	Full Covered
13495	Full Covered	14107	Mostly Covered	14432	Full Covered	14618	Full Covered	15012	Full Covered	15134	Full Covered
13501	Full Covered	14108	Full Covered	14435	Full Covered	14619	Full Covered	15014	Full Covered	15135	Full Covered
13502	Full Covered	14109	Full Covered	14437	Mostly Covered	14620	Full Covered	15015	Full Covered	15136	Full Covered
13503	Full Covered	14110	Full Covered	14443	Mostly Covered	14621	Full Covered	15017	Full Covered	15137	Full Covered
13504	Full Covered	14111	Mostly Covered	14445	Full Covered	14622	Full Covered	15018	Full Covered	15139	Full Covered
13505	Full Covered	14113	Mostly Covered	14449	Mostly Covered	14623	Full Covered	15019	Full Covered	15140	Full Covered
13599	Full Covered	14120	Full Covered	14450	Full Covered	14624	Full Covered	15020	Full Covered	15142	Full Covered
13601	Full Covered	14125	Mostly Covered	14452	Mostly Covered	14625	Full Covered	15021	Mostly Covered	15143	Full Covered
13603	Mostly Covered	14127	Full Covered	14453	Full Covered	14626	Full Covered	15022	Full Covered	15144	Full Covered
13606	Mostly Covered	14131	Mostly Covered	14454	Full Covered	14627	Full Covered	15024	Full Covered	15145	Full Covered
13612	Mostly Covered	14132	Full Covered	14461	Full Covered	14638	Full Covered	15025	Full Covered	15146	Full Covered
13615	Full Covered	14139	Full Covered	14462	Full Covered	14639	Full Covered	15026	Full Covered	15147	Full Covered
13616	Full Covered	14140	Mostly Covered	14463	Mostly Covered	14642	Full Covered	15027	Full Covered	15148	Full Covered
13634	Mostly Covered	14141	Mostly Covered	14464	Full Covered	14643	Full Covered	15028	Full Covered	15201	Full Covered
13637	Full Covered	14143	Full Covered	14466	Mostly Covered	14644	Full Covered	15030	Full Covered	15202	Full Covered
13638	Mostly Covered	14144	Mostly Covered	14467	Full Covered	14645	Full Covered	15031	Full Covered	15203	Full Covered
13656	Mostly Covered	14145	Full Covered	14468	Mostly Covered	14646	Full Covered	15032	Full Covered	15204	Full Covered
13657	Mostly Covered	14150	Full Covered	14469	Mostly Covered	14647	Full Covered	15033	Full Covered	15205	Full Covered
13682	Mostly Covered	14151	Full Covered	14470	Full Covered	14649	Full Covered	15034	Full Covered	15206	Full Covered
13732	Full Covered	14166	Full Covered	14472	Full Covered	14650	Full Covered	15035	Full Covered	15207	Full Covered
13737	Full Covered	14167	Mostly Covered	14475	Mostly Covered	14651	Full Covered	15036	Full Covered	15208	Full Covered
13738	Mostly Covered	14169	Full Covered	14476	Mostly Covered	14652	Full Covered	15037	Full Covered	15209	Full Covered
13745	Mostly Covered	14170	Full Covered	14480	Mostly Covered	14653	Full Covered	15038	Full Covered	15210	Full Covered
13748	Mostly Covered	14172	Mostly Covered	14485	Mostly Covered	14664	Full Covered	15042	Full Covered	15211	Full Covered
13749	Mostly Covered	14201	Full Covered	14487	Mostly Covered	14673	Full Covered	15044	Full Covered	15212	Full Covered
13760	Mostly Covered	14202	Full Covered	14488	Mostly Covered	14683	Full Covered	15045	Full Covered	15213	Full Covered
13761	Full Covered	14203	Full Covered	14489	Full Covered	14692	Full Covered	15046	Full Covered	15214	Full Covered
13762	Full Covered	14204	Full Covered	14502	Full Covered	14694	Full Covered	15047	Full Covered	15215	Full Covered
13763	Full Covered	14205	Full Covered	14504	Full Covered	14701	Full Covered	15049	Full Covered	15216	Full Covered
13790	Mostly Covered	14206	Full Covered	14505	Mostly Covered	14702	Full Covered	15050	Mostly Covered	15217	Full Covered
13795	Mostly Covered	14207	Full Covered	14506	Full Covered	14703	Full Covered	15051	Full Covered	15218	Full Covered
13812	Mostly Covered	14208	Full Covered	14508	Mostly Covered	14704	Full Covered	15052	Mostly Covered	15219	Full Covered
13827	Full Covered	14209	Full Covered	14510	Mostly Covered	14712	Mostly Covered	15053	Mostly Covered	15220	Full Covered
13845	Mostly Covered	14210	Full Covered	14513	Full Covered	14716	Full Covered	15054	Mostly Covered	15221	Full Covered
13850	Full Covered	14211	Full Covered	14514	Full Covered	14718	Full Covered	15055	Full Covered	15222	Full Covered
13851	Full Covered	14212	Full Covered	14515	Full Covered	14720	Full Covered	15056	Full Covered	15223	Full Covered
13864	Mostly Covered	14213	Full Covered	14518	Mostly Covered	14722	Mostly Covered	15057	Full Covered	15224	Full Covered
13901	Mostly Covered	14214	Full Covered	14519	Full Covered	14728	Full Covered	15060	Full Covered	15225	Full Covered
13902	Full Covered	14215	Full Covered	14520	Full Covered	14732	Mostly Covered	15061	Full Covered	15226	Full Covered
13903	Full Covered	14216	Full Covered	14522	Full Covered	14733	Full Covered	15062	Full Covered	15227	Full Covered
13904	Mostly Covered	14217	Full Covered	14526	Full Covered	14738	Mostly Covered	15063	Mostly Covered	15228	Full Covered
13905	Mostly Covered	14218	Full Covered	14529	Full Covered	14740	Full Covered	15064	Full Covered	15229	Full Covered
14001	Full Covered	14219	Full Covered	14532	Mostly Covered	14742	Full Covered	15065	Mostly Covered	15230	Full Covered
14004	Full Covered	14220	Full Covered	14534	Full Covered	14747	Mostly Covered	15066	Full Covered	15231	Full Covered
14005	Full Covered	14221	Full Covered	14537	Full Covered	14750	Full Covered	15067	Full Covered	15232	Full Covered
14010	Full Covered	14222	Full Covered	14538	Mostly Covered	14752	Full Covered	15068	Full Covered	15233	Full Covered
14011	Mostly Covered	14223	Full Covered	14542	Full Covered	14756	Mostly Covered	15069	Full Covered	15234	Full Covered
14013	Mostly Covered	14224	Full Covered	14543	Full Covered	14757	Mostly Covered	15071	Full Covered	15235	Full Covered
14020	Full Covered	14225	Full Covered	14544	Full Covered	14769	Full Covered	15072	Full Covered	15236	Full Covered
14021	Full Covered	14226	Full Covered	14545	Full Covered	14782	Mostly Covered	15074	Full Covered	15237	Full Covered
14025	Full Covered	14227	Full Covered	14546	Mostly Covered	14784	Full Covered	15075	Full Covered	15238	Full Covered
14026	Full Covered	14228	Full Covered	14547	Full Covered	14807	Full Covered	15076	Full Covered	15239	Full Covered
14028	Mostly Covered	14231	Full Covered	14548	Mostly Covered	14808	Mostly Covered	15077	Mostly Covered	15240	Full Covered
14031	Full Covered	14233	Full Covered	14551	Mostly Covered	14816	Mostly Covered	15081	Full Covered	15241	Full Covered
14032	Mostly Covered	14240	Full Covered	14556	Full Covered	14817	Mostly Covered	15082	Full Covered	15242	Full Covered
14033	Full Covered	14241	Full Covered	14557	Full Covered	14825	Mostly Covered	15083	Full Covered	15243	Full Covered
14036	Full Covered	14260	Full Covered	14558	Mostly Covered	14826	Mostly Covered	15084	Full Covered	15244	Full Covered
14037	Full Covered	14261	Full Covered	14559	Full Covered	14843	Mostly Covered	15085	Full Covered	15250	Full Covered
14038	Full Covered	14263	Full Covered	14560	Mostly Covered	14844	Mostly Covered	15086	Full Covered	15251	Full Covered
14039	Mostly Covered	14264	Full Covered	14561	Full Covered	14850	Full Covered	15087	Full Covered	15252	Full Covered
14040	Mostly Covered	14265	Full Covered	14563	Full Covered	14851	Full Covered	15088	Full Covered	15253	Full Covered
14043	Full Covered	14267	Full Covered	14564	Full Covered	14852	Full Covered	15089	Full Covered	15254	Full Covered
14048	Mostly Covered	14269	Full Covered	14568	Full Covered	14853	Full Covered	15090	Full Covered	15255	Full Covered
14051	Full Covered	14270	Full Covered	14572	Full Covered	14854	Mostly Covered	15091	Full Covered	15257	Full Covered
14052	Full Covered	14272	Full Covered	14580	Full Covered	14861	Mostly Covered	15095	Full Covered	15258	Full Covered
14054	Full Covered	14273	Full Covered	14585	Mostly Covered	14867	Mostly Covered	15096	Full Covered	15259	Full Covered
14056	Mostly Covered	14276	Full Covered	14586	Full Covered	14871	Mostly Covered	15101	Full Covered	15260	Full Covered
14057	Mostly Covered	14280	Full Covered	14591	Mostly Covered	14881	Mostly Covered	15102	Full Covered	15261	Full Covered
14058	Full Covered	14301	Full Covered	14602	Full Covered	14882	Mostly Covered	15104	Full Covered	15262	Full Covered
14059	Mostly Covered	14302	Full Covered	14603	Full Covered	14883	Mostly Covered	15106	Full Covered	15263	Full Covered
14063	Full Covered	14303	Full Covered	14604	Full Covered	14894	Full Covered	15108	Full Covered	15264	Full Covered
14068	Full Covered	14304	Full Covered	14605	Full Covered	14901	Full Covered	15110	Full Covered	15265	Full Covered
14069	Mostly Covered	14305	Full Covered	14606	Full Covered	14902	Full Covered	15112	Full Covered	15267	Full Covered
14072	Full Covered	14410	Full Covered	14607	Full Covered	14903	Mostly Covered	15116	Full Covered	15268	Full Covered
14075	Full Covered	14413	Mostly Covered	14608	Full Covered	14904	Full Covered	15120	Full Covered	15270	Full Covered
14080	Mostly Covered	14414	Mostly Covered	14609	Full Covered	14905	Full Covered	15122	Full Covered	15272	Full Covered
14082	Mostly Covered	14416	Mostly Covered	14610	Full Covered	14925	Full Covered	15123	Full Covered	15274	Full Covered
14083	Full Covered	14420	Full Covered	14611	Full Covered	15001	Full Covered	15126	Full Covered	15275	Full Covered

Zip Code	Coverage Level	Zip Code	Coverage Level	Zip Code	Coverage Level	Zip Code	Coverage Level	Zip Code	Coverage Level	Zip Code	Coverage Level
15276	Full Covered	15606	Full Covered	15945	Full Covered	16530	Full Covered	17091	Full Covered	17565	Mostly Covered
15277	Full Covered	15611	Full Covered	15949	Mostly Covered	16531	Full Covered	17093	Full Covered	17568	Full Covered
15278	Full Covered	15612	Mostly Covered	15951	Mostly Covered	16532	Full Covered	17101	Full Covered	17572	Mostly Covered
15279	Full Covered	15615	Full Covered	15952	Mostly Covered	16533	Full Covered	17102	Full Covered	17573	Mostly Covered
15281	Full Covered	15616	Full Covered	15953	Full Covered	16534	Full Covered	17103	Full Covered	17575	Mostly Covered
15282	Full Covered	15617	Full Covered	15954	Full Covered	16538	Full Covered	17104	Full Covered	17576	Full Covered
15283	Full Covered	15619	Full Covered	15956	Full Covered	16541	Full Covered	17105	Full Covered	17579	Mostly Covered
15285	Full Covered	15621	Mostly Covered	15958	Mostly Covered	16544	Full Covered	17106	Full Covered	17580	Full Covered
15286	Full Covered	15623	Full Covered	15959	Full Covered	16546	Full Covered	17107	Full Covered	17582	Mostly Covered
15289	Full Covered	15624	Full Covered	15960	Mostly Covered	16550	Full Covered	17108	Full Covered	17583	Full Covered
15290	Full Covered	15625	Full Covered	15961	Mostly Covered	16553	Full Covered	17109	Full Covered	17584	Full Covered
15295	Full Covered	15626	Full Covered	15963	Mostly Covered	16554	Full Covered	17110	Full Covered	17585	Full Covered
15301	Full Covered	15632	Mostly Covered	16001	Full Covered	16563	Full Covered	17111	Full Covered	17601	Full Covered
15311	Mostly Covered	15633	Full Covered	16002	Full Covered	16565	Full Covered	17112	Full Covered	17602	Full Covered
15312	Mostly Covered	15634	Full Covered	16003	Full Covered	16601	Full Covered	17113	Full Covered	17603	Full Covered
15314	Mostly Covered	15635	Full Covered	16023	Mostly Covered	16602	Full Covered	17120	Full Covered	17604	Full Covered
15317	Full Covered	15636	Full Covered	16024	Full Covered	16603	Full Covered	17121	Full Covered	17605	Full Covered
15321	Full Covered	15637	Mostly Covered	16025	Mostly Covered	16613	Full Covered	17122	Full Covered	17606	Full Covered
15323	Full Covered	15639	Full Covered	16027	Full Covered	16617	Full Covered	17123	Full Covered	17607	Full Covered
15324	Mostly Covered	15640	Mostly Covered	16029	Full Covered	16619	Mostly Covered	17124	Full Covered	17608	Full Covered
15329	Mostly Covered	15642	Mostly Covered	16033	Full Covered	16624	Mostly Covered	17125	Full Covered	18001	Full Covered
15330	Full Covered	15644	Full Covered	16034	Mostly Covered	16629	Full Covered	17126	Full Covered	18002	Mostly Covered
15331	Mostly Covered	15647	Full Covered	16037	Mostly Covered	16630	Mostly Covered	17127	Full Covered	18015	Full Covered
15332	Full Covered	15650	Mostly Covered	16039	Full Covered	16635	Mostly Covered	17128	Full Covered	18016	Full Covered
15336	Full Covered	15660	Mostly Covered	16045	Full Covered	16636	Full Covered	17129	Full Covered	18017	Mostly Covered
15337	Mostly Covered	15662	Full Covered	16046	Full Covered	16639	Mostly Covered	17130	Full Covered	18018	Full Covered
15339	Full Covered	15663	Full Covered	16051	Mostly Covered	16641	Mostly Covered	17140	Full Covered	18020	Mostly Covered
15340	Mostly Covered	15664	Mostly Covered	16053	Mostly Covered	16644	Mostly Covered	17177	Full Covered	18025	Full Covered
15342	Full Covered	15665	Full Covered	16056	Mostly Covered	16648	Mostly Covered	17225	Mostly Covered	18032	Full Covered
15347	Full Covered	15666	Mostly Covered	16059	Mostly Covered	16652	Mostly Covered	17241	Mostly Covered	18034	Full Covered
15350	Full Covered	15668	Full Covered	16061	Mostly Covered	16665	Mostly Covered	17256	Mostly Covered	18036	Full Covered
15353	Mostly Covered	15672	Full Covered	16063	Full Covered	16669	Mostly Covered	17263	Full Covered	18037	Mostly Covered
15360	Mostly Covered	15674	Mostly Covered	16066	Full Covered	16684	Mostly Covered	17272	Mostly Covered	18041	Mostly Covered
15361	Full Covered	15675	Full Covered	16101	Full Covered	16699	Mostly Covered	17313	Full Covered	18046	Mostly Covered
15363	Full Covered	15676	Mostly Covered	16102	Full Covered	16801	Full Covered	17315	Full Covered	18049	Full Covered
15365	Full Covered	15678	Mostly Covered	16103	Full Covered	16802	Full Covered	17316	Mostly Covered	18052	Mostly Covered
15366	Full Covered	15679	Mostly Covered	16105	Full Covered	16803	Full Covered	17317	Mostly Covered	18054	Full Covered
15367	Full Covered	15684	Mostly Covered	16107	Full Covered	16804	Full Covered	17318	Full Covered	18055	Mostly Covered
15376	Full Covered	15685	Mostly Covered	16108	Full Covered	16805	Full Covered	17319	Full Covered	18056	Mostly Covered
15377	Mostly Covered	15688	Mostly Covered	16112	Full Covered	16827	Mostly Covered	17323	Mostly Covered	18060	Full Covered
15378	Full Covered	15689	Mostly Covered	16116	Full Covered	16851	Full Covered	17339	Full Covered	18062	Mostly Covered
15379	Mostly Covered	15691	Full Covered	16117	Mostly Covered	16865	Full Covered	17342	Mostly Covered	18065	Mostly Covered
15412	Full Covered	15692	Full Covered	16120	Mostly Covered	16888	Full Covered	17345	Full Covered	18067	Mostly Covered
15413	Mostly Covered	15695	Full Covered	16123	Mostly Covered	16870	Mostly Covered	17347	Full Covered	18068	Full Covered
15415	Mostly Covered	15697	Full Covered	16132	Full Covered	16914	Mostly Covered	17356	Mostly Covered	18070	Mostly Covered
15417	Mostly Covered	15698	Mostly Covered	16136	Full Covered	16925	Full Covered	17358	Full Covered	18073	Mostly Covered
15419	Mostly Covered	15701	Full Covered	16140	Full Covered	17001	Full Covered	17360	Mostly Covered	18074	Mostly Covered
15422	Mostly Covered	15705	Full Covered	16141	Mostly Covered	17008	Mostly Covered	17364	Mostly Covered	18076	Mostly Covered
15423	Mostly Covered	15713	Full Covered	16142	Mostly Covered	17011	Full Covered	17365	Full Covered	18077	Mostly Covered
15427	Mostly Covered	15716	Mostly Covered	16143	Mostly Covered	17012	Mostly Covered	17366	Mostly Covered	18081	Mostly Covered
15428	Mostly Covered	15717	Mostly Covered	16155	Full Covered	17013	Full Covered	17368	Mostly Covered	18084	Mostly Covered
15432	Full Covered	15720	Mostly Covered	16156	Mostly Covered	17016	Mostly Covered	17370	Full Covered	18087	Mostly Covered
15434	Full Covered	15723	Full Covered	16157	Full Covered	17018	Full Covered	17371	Full Covered	18092	Full Covered
15438	Full Covered	15725	Mostly Covered	16160	Full Covered	17019	Mostly Covered	17401	Full Covered	18098	Full Covered
15442	Mostly Covered	15727	Full Covered	16172	Mostly Covered	17024	Mostly Covered	17402	Full Covered	18099	Full Covered
15444	Mostly Covered	15731	Full Covered	16211	Mostly Covered	17025	Mostly Covered	17403	Full Covered	18101	Full Covered
15448	Full Covered	15732	Full Covered	16246	Mostly Covered	17027	Mostly Covered	17404	Full Covered	18102	Full Covered
15466	Full Covered	15736	Mostly Covered	16249	Mostly Covered	17028	Mostly Covered	17405	Full Covered	18103	Full Covered
15473	Full Covered	15747	Mostly Covered	16250	Mostly Covered	17032	Mostly Covered	17406	Full Covered	18104	Mostly Covered
15477	Full Covered	15748	Mostly Covered	16403	Full Covered	17034	Full Covered	17407	Full Covered	18105	Full Covered
15479	Full Covered	15752	Full Covered	16412	Full Covered	17036	Mostly Covered	17415	Full Covered	18106	Mostly Covered
15480	Mostly Covered	15754	Full Covered	16415	Mostly Covered	17039	Mostly Covered	17501	Mostly Covered	18109	Full Covered
15482	Full Covered	15756	Full Covered	16421	Mostly Covered	17040	Full Covered	17502	Mostly Covered	18175	Mostly Covered
15483	Full Covered	15774	Mostly Covered	16426	Full Covered	17041	Mostly Covered	17504	Full Covered	18195	Mostly Covered
15486	Mostly Covered	15783	Mostly Covered	16427	Full Covered	17042	Full Covered	17505	Full Covered	18221	Mostly Covered
15492	Full Covered	15901	Full Covered	16433	Mostly Covered	17043	Full Covered	17508	Mostly Covered	18222	Mostly Covered
15501	Full Covered	15902	Full Covered	16440	Full Covered	17046	Mostly Covered	17512	Mostly Covered	18224	Mostly Covered
15502	Full Covered	15904	Full Covered	16441	Full Covered	17050	Mostly Covered	17516	Full Covered	18410	Full Covered
15510	Full Covered	15905	Full Covered	16444	Full Covered	17053	Mostly Covered	17520	Full Covered	18411	Full Covered
15520	Full Covered	15906	Full Covered	16501	Full Covered	17055	Mostly Covered	17521	Full Covered	18414	Full Covered
15530	Mostly Covered	15907	Full Covered	16502	Full Covered	17057	Mostly Covered	17527	Mostly Covered	18416	Mostly Covered
15541	Full Covered	15909	Full Covered	16503	Full Covered	17064	Mostly Covered	17532	Mostly Covered	18419	Mostly Covered
15542	Mostly Covered	15920	Mostly Covered	16504	Full Covered	17065	Mostly Covered	17533	Full Covered	18420	Mostly Covered
15544	Mostly Covered	15922	Mostly Covered	16505	Full Covered	17067	Mostly Covered	17537	Full Covered	18434	Mostly Covered
15546	Mostly Covered	15928	Full Covered	16506	Full Covered	17068	Mostly Covered	17538	Mostly Covered	18440	Mostly Covered
15547	Mostly Covered	15929	Full Covered	16507	Full Covered	17070	Full Covered	17540	Mostly Covered	18447	Mostly Covered
15548	Mostly Covered	15930	Mostly Covered	16508	Full Covered	17073	Mostly Covered	17543	Full Covered	18448	Mostly Covered
15549	Full Covered	15934	Full Covered	16509	Full Covered	17077	Mostly Covered	17545	Full Covered	18452	Mostly Covered
15555	Full Covered	15935	Mostly Covered	16510	Full Covered	17081	Full Covered	17547	Mostly Covered	18471	Full Covered
15560	Mostly Covered	15936	Mostly Covered	16511	Full Covered	17083	Mostly Covered	17550	Mostly Covered	18501	Full Covered
15561	Full Covered	15937	Mostly Covered	16512	Full Covered	17085	Mostly Covered	17551	Full Covered	18502	Full Covered
15563	Mostly Covered	15942	Full Covered	16514	Full Covered	17088	Full Covered	17554	Full Covered	18503	Full Covered
15601	Full Covered	15943	Mostly Covered	16515	Full Covered	17089	Full Covered	17560	Mostly Covered	18504	Full Covered
15605	Full Covered	15944	Full Covered	16522	Full Covered	17090	Full Covered	17564	Full Covered	18505	Full Covered

Zip Code	Coverage Level	Zip Code	Coverage Level	Zip Code	Coverage Level	Zip Code	Coverage Level	Zip Code	Coverage Level	Zip Code	Coverage Level
18507	Full Covered	18949	Full Covered	19072	Full Covered	19173	Full Covered	19428	Full Covered	19612	Full Covered
18508	Full Covered	18950	Mostly Covered	19073	Full Covered	19175	Full Covered	19429	Full Covered	19640	Full Covered
18509	Full Covered	18951	Full Covered	19074	Full Covered	19177	Full Covered	19430	Mostly Covered	19701	Full Covered
18510	Full Covered	18954	Full Covered	19075	Full Covered	19178	Full Covered	19432	Full Covered	19702	Full Covered
18512	Mostly Covered	18955	Full Covered	19076	Full Covered	19181	Full Covered	19435	Mostly Covered	19703	Full Covered
18514	Full Covered	18956	Full Covered	19078	Full Covered	19182	Full Covered	19436	Full Covered	19706	Full Covered
18515	Full Covered	18957	Mostly Covered	19079	Full Covered	19184	Full Covered	19437	Full Covered	19707	Full Covered
18517	Full Covered	18958	Full Covered	19080	Full Covered	19185	Full Covered	19438	Mostly Covered	19708	Full Covered
18518	Full Covered	18960	Full Covered	19081	Full Covered	19187	Full Covered	19440	Full Covered	19709	Mostly Covered
18519	Full Covered	18962	Full Covered	19082	Full Covered	19188	Full Covered	19441	Full Covered	19710	Full Covered
18522	Full Covered	18963	Mostly Covered	19083	Full Covered	19191	Full Covered	19442	Full Covered	19711	Full Covered
18577	Full Covered	18964	Full Covered	19085	Full Covered	19192	Full Covered	19443	Mostly Covered	19712	Full Covered
18602	Full Covered	18966	Full Covered	19086	Full Covered	19193	Full Covered	19444	Full Covered	19713	Full Covered
18615	Mostly Covered	18968	Full Covered	19087	Full Covered	19194	Full Covered	19446	Full Covered	19714	Full Covered
18625	Mostly Covered	18969	Full Covered	19088	Full Covered	19195	Full Covered	19450	Full Covered	19715	Full Covered
18634	Mostly Covered	18970	Full Covered	19089	Full Covered	19196	Full Covered	19451	Mostly Covered	19716	Full Covered
18640	Mostly Covered	18971	Full Covered	19090	Full Covered	19197	Full Covered	19453	Full Covered	19717	Full Covered
18641	Full Covered	18974	Full Covered	19091	Full Covered	19244	Full Covered	19454	Full Covered	19718	Full Covered
18642	Full Covered	18976	Full Covered	19092	Full Covered	19255	Full Covered	19455	Mostly Covered	19720	Full Covered
18643	Mostly Covered	18977	Mostly Covered	19093	Full Covered	19301	Full Covered	19456	Full Covered	19721	Full Covered
18644	Mostly Covered	18979	Mostly Covered	19094	Full Covered	19310	Mostly Covered	19457	Full Covered	19725	Full Covered
18651	Mostly Covered	18980	Full Covered	19095	Full Covered	19311	Mostly Covered	19460	Full Covered	19726	Full Covered
18653	Full Covered	18981	Full Covered	19096	Full Covered	19312	Full Covered	19462	Full Covered	19732	Full Covered
18661	Mostly Covered	18991	Full Covered	19098	Full Covered	19316	Full Covered	19464	Full Covered	19733	Mostly Covered
18701	Full Covered	19001	Full Covered	19101	Full Covered	19317	Full Covered	19465	Full Covered	19735	Full Covered
18702	Full Covered	19002	Full Covered	19102	Full Covered	19318	Mostly Covered	19468	Mostly Covered	19736	Full Covered
18703	Full Covered	19003	Full Covered	19103	Full Covered	19319	Full Covered	19470	Full Covered	19801	Full Covered
18704	Full Covered	19004	Full Covered	19104	Full Covered	19320	Full Covered	19472	Full Covered	19802	Full Covered
18705	Full Covered	19006	Full Covered	19105	Full Covered	19330	Mostly Covered	19473	Mostly Covered	19803	Full Covered
18706	Full Covered	19007	Full Covered	19106	Full Covered	19331	Full Covered	19474	Mostly Covered	19804	Full Covered
18707	Full Covered	19008	Full Covered	19107	Full Covered	19333	Full Covered	19475	Full Covered	19805	Full Covered
18708	Mostly Covered	19009	Full Covered	19108	Full Covered	19335	Full Covered	19477	Full Covered	19806	Full Covered
18709	Mostly Covered	19010	Full Covered	19109	Full Covered	19339	Full Covered	19478	Mostly Covered	19807	Full Covered
18710	Full Covered	19012	Full Covered	19110	Full Covered	19341	Full Covered	19480	Full Covered	19808	Full Covered
18711	Full Covered	19013	Full Covered	19111	Full Covered	19342	Full Covered	19481	Full Covered	19809	Full Covered
18761	Full Covered	19014	Full Covered	19112	Full Covered	19343	Mostly Covered	19482	Full Covered	19810	Full Covered
18762	Full Covered	19015	Full Covered	19113	Full Covered	19344	Mostly Covered	19483	Full Covered	19850	Full Covered
18763	Full Covered	19016	Full Covered	19114	Full Covered	19345	Full Covered	19484	Full Covered	19880	Full Covered
18764	Full Covered	19017	Full Covered	19115	Full Covered	19346	Mostly Covered	19485	Full Covered	19884	Full Covered
18765	Full Covered	19018	Full Covered	19116	Full Covered	19347	Full Covered	19486	Full Covered	19885	Full Covered
18766	Full Covered	19019	Full Covered	19118	Full Covered	19348	Mostly Covered	19487	Full Covered	19886	Full Covered
18767	Full Covered	19020	Full Covered	19119	Full Covered	19350	Full Covered	19489	Full Covered	19887	Full Covered
18769	Full Covered	19021	Full Covered	19120	Full Covered	19351	Mostly Covered	19490	Full Covered	19889	Full Covered
18773	Full Covered	19022	Full Covered	19121	Full Covered	19352	Mostly Covered	19492	Mostly Covered	19890	Full Covered
18774	Full Covered	19023	Full Covered	19122	Full Covered	19353	Full Covered	19493	Full Covered	19891	Full Covered
18812	Full Covered	19025	Full Covered	19123	Full Covered	19354	Full Covered	19494	Full Covered	19892	Full Covered
18818	Mostly Covered	19026	Full Covered	19124	Full Covered	19355	Full Covered	19495	Full Covered	19893	Full Covered
18822	Mostly Covered	19027	Full Covered	19125	Full Covered	19357	Mostly Covered	19496	Full Covered	19894	Full Covered
18829	Mostly Covered	19028	Full Covered	19126	Full Covered	19358	Full Covered	19503	Mostly Covered	19895	Full Covered
18830	Mostly Covered	19029	Full Covered	19127	Full Covered	19365	Full Covered	19504	Mostly Covered	19896	Full Covered
18837	Mostly Covered	19030	Full Covered	19128	Full Covered	19366	Full Covered	19505	Mostly Covered	19897	Full Covered
18851	Full Covered	19031	Full Covered	19129	Full Covered	19367	Full Covered	19508	Full Covered	19898	Full Covered
18901	Full Covered	19032	Full Covered	19130	Full Covered	19369	Full Covered	19510	Full Covered	19899	Full Covered
18910	Mostly Covered	19033	Full Covered	19131	Full Covered	19371	Mostly Covered	19512	Full Covered	19901	Mostly Covered
18911	Full Covered	19034	Full Covered	19132	Full Covered	19372	Full Covered	19516	Mostly Covered	19902	Full Covered
18912	Full Covered	19035	Full Covered	19133	Full Covered	19373	Full Covered	19518	Full Covered	19903	Full Covered
18913	Full Covered	19036	Full Covered	19134	Full Covered	19374	Mostly Covered	19519	Full Covered	19904	Full Covered
18914	Full Covered	19037	Full Covered	19135	Mostly Covered	19375	Mostly Covered	19520	Mostly Covered	19905	Full Covered
18915	Mostly Covered	19038	Full Covered	19136	Full Covered	19376	Full Covered	19522	Mostly Covered	19906	Full Covered
18916	Full Covered	19039	Full Covered	19137	Full Covered	19380	Full Covered	19523	Mostly Covered	19934	Full Covered
18917	Full Covered	19040	Full Covered	19138	Full Covered	19381	Full Covered	19525	Full Covered	19936	Full Covered
18918	Full Covered	19041	Full Covered	19139	Full Covered	19382	Full Covered	19533	Full Covered	19940	Mostly Covered
18922	Full Covered	19043	Full Covered	19140	Full Covered	19383	Full Covered	19535	Full Covered	19943	Full Covered
18923	Full Covered	19044	Full Covered	19141	Full Covered	19390	Mostly Covered	19540	Mostly Covered	19944	Mostly Covered
18924	Full Covered	19046	Full Covered	19142	Full Covered	19395	Full Covered	19541	Mostly Covered	19945	Mostly Covered
18925	Full Covered	19047	Full Covered	19143	Full Covered	19397	Full Covered	19542	Full Covered	19946	Full Covered
18926	Full Covered	19048	Full Covered	19144	Full Covered	19398	Full Covered	19543	Mostly Covered	19952	Mostly Covered
18927	Full Covered	19049	Full Covered	19145	Full Covered	19399	Full Covered	19545	Full Covered	19953	Mostly Covered
18928	Full Covered	19050	Full Covered	19146	Full Covered	19401	Full Covered	19547	Mostly Covered	19954	Mostly Covered
18929	Full Covered	19052	Full Covered	19147	Full Covered	19403	Full Covered	19548	Full Covered	19961	Mostly Covered
18930	Mostly Covered	19053	Full Covered	19148	Full Covered	19404	Full Covered	19555	Mostly Covered	19962	Full Covered
18931	Full Covered	19054	Full Covered	19149	Mostly Covered	19405	Full Covered	19560	Full Covered	19964	Mostly Covered
18932	Mostly Covered	19055	Full Covered	19150	Full Covered	19406	Full Covered	19564	Mostly Covered	19975	Full Covered
18933	Mostly Covered	19056	Full Covered	19151	Full Covered	19407	Full Covered	19601	Full Covered	19979	Full Covered
18934	Full Covered	19057	Full Covered	19152	Full Covered	19408	Full Covered	19602	Full Covered	19980	Full Covered
18935	Full Covered	19058	Full Covered	19153	Full Covered	19409	Full Covered	19603	Full Covered	20001	Full Covered
18936	Mostly Covered	19059	Full Covered	19154	Full Covered	19415	Full Covered	19604	Full Covered	20002	Full Covered
18938	Mostly Covered	19061	Full Covered	19155	Full Covered	19420	Full Covered	19605	Full Covered	20003	Full Covered
18940	Full Covered	19063	Full Covered	19160	Full Covered	19421	Full Covered	19606	Full Covered	20004	Full Covered
18942	Mostly Covered	19064	Full Covered	19161	Full Covered	19422	Full Covered	19607	Full Covered	20005	Full Covered
18943	Mostly Covered	19065	Full Covered	19162	Full Covered	19423	Full Covered	19608	Mostly Covered	20006	Full Covered
18944	Full Covered	19066	Full Covered	19170	Full Covered	19424	Full Covered	19609	Full Covered	20007	Full Covered
18946	Full Covered	19067	Full Covered	19171	Full Covered	19425	Full Covered	19610	Full Covered	20008	Full Covered
18947	Mostly Covered	19070	Full Covered	19172	Full Covered	19426	Full Covered	19611	Full Covered	20009	Full Covered

Zip Code	Coverage Level	Zip Code	Coverage Level	Zip Code	Coverage Level	Zip Code	Coverage Level	Zip Code	Coverage Level	Zip Code	Coverage Level
20902	Full Covered	21123	Full Covered	21297	Full Covered	21810	Full Covered	22184	Full Covered	22728	Mostly Covered
20903	Full Covered	21128	Full Covered	21298	Full Covered	21811	Full Covered	22185	Full Covered	22734	Mostly Covered
20904	Full Covered	21130	Full Covered	21401	Full Covered	21813	Full Covered	22191	Full Covered	22801	Full Covered
20905	Full Covered	21131	Full Covered	21402	Full Covered	21822	Full Covered	22192	Full Covered	22802	Full Covered
20906	Full Covered	21133	Full Covered	21403	Full Covered	21826	Full Covered	22193	Full Covered	22803	Full Covered
20907	Full Covered	21136	Full Covered	21404	Full Covered	21830	Mostly Covered	22194	Full Covered	22807	Full Covered
20908	Full Covered	21139	Full Covered	21405	Full Covered	21835	Full Covered	22195	Full Covered	22812	Mostly Covered
20910	Full Covered	21140	Full Covered	21411	Full Covered	21841	Mostly Covered	22199	Full Covered	22832	Mostly Covered
20911	Full Covered	21144	Full Covered	21412	Full Covered	21842	Full Covered	22201	Full Covered	22833	Mostly Covered
20912	Full Covered	21146	Full Covered	21601	Full Covered	21843	Full Covered	22202	Full Covered	22834	Mostly Covered
20913	Full Covered	21150	Full Covered	21606	Full Covered	21849	Mostly Covered	22203	Full Covered	22840	Mostly Covered
20914	Full Covered	21152	Full Covered	21609	Full Covered	21853	Mostly Covered	22204	Full Covered	22841	Full Covered
20915	Full Covered	21153	Full Covered	21613	Mostly Covered	21856	Mostly Covered	22205	Full Covered	22846	Full Covered
20916	Full Covered	21154	Mostly Covered	21617	Full Covered	21862	Full Covered	22206	Full Covered	22848	Full Covered
20918	Full Covered	21155	Mostly Covered	21625	Full Covered	21869	Mostly Covered	22207	Full Covered	22850	Mostly Covered
20997	Full Covered	21156	Full Covered	21631	Full Covered	21872	Mostly Covered	22209	Full Covered	22901	Mostly Covered
21001	Full Covered	21157	Full Covered	21638	Full Covered	21874	Mostly Covered	22210	Full Covered	22902	Full Covered
21005	Full Covered	21158	Full Covered	21643	Mostly Covered	21875	Full Covered	22211	Full Covered	22903	Mostly Covered
21009	Full Covered	21162	Full Covered	21654	Mostly Covered	21901	Mostly Covered	22213	Full Covered	22904	Full Covered
21010	Full Covered	21163	Full Covered	21655	Mostly Covered	21902	Full Covered	22214	Full Covered	22905	Full Covered
21012	Full Covered	21201	Full Covered	21657	Full Covered	21903	Full Covered	22215	Full Covered	22906	Full Covered
21013	Mostly Covered	21202	Full Covered	21658	Full Covered	21904	Full Covered	22216	Full Covered	22908	Full Covered
21014	Full Covered	21203	Full Covered	21659	Mostly Covered	21911	Mostly Covered	22217	Full Covered	22909	Full Covered
21015	Full Covered	21204	Full Covered	21664	Full Covered	21914	Mostly Covered	22219	Full Covered	22910	Full Covered
21017	Full Covered	21205	Full Covered	21673	Mostly Covered	21916	Mostly Covered	22222	Full Covered	22911	Mostly Covered
21018	Full Covered	21206	Full Covered	21679	Full Covered	21917	Full Covered	22226	Full Covered	22936	Mostly Covered
21020	Full Covered	21207	Full Covered	21701	Mostly Covered	21918	Mostly Covered	22227	Full Covered	22945	Mostly Covered
21022	Full Covered	21208	Full Covered	21702	Full Covered	21920	Full Covered	22229	Full Covered	22946	Mostly Covered
21023	Full Covered	21209	Full Covered	21703	Full Covered	21921	Full Covered	22230	Full Covered	22947	Mostly Covered
21027	Full Covered	21210	Full Covered	21704	Mostly Covered	21922	Full Covered	22234	Full Covered	22959	Mostly Covered
21028	Full Covered	21211	Full Covered	21705	Full Covered	22003	Full Covered	22240	Full Covered	23001	Full Covered
21029	Full Covered	21212	Full Covered	21709	Full Covered	22009	Full Covered	22242	Full Covered	23005	Mostly Covered
21030	Full Covered	21213	Full Covered	21710	Full Covered	22015	Full Covered	22243	Full Covered	23009	Mostly Covered
21031	Full Covered	21214	Full Covered	21713	Full Covered	22026	Full Covered	22244	Full Covered	23011	Full Covered
21032	Full Covered	21215	Full Covered	21714	Full Covered	22027	Full Covered	22245	Full Covered	23017	Mostly Covered
21034	Mostly Covered	21216	Full Covered	21715	Mostly Covered	22030	Full Covered	22246	Full Covered	23018	Full Covered
21035	Full Covered	21217	Full Covered	21716	Full Covered	22031	Full Covered	22248	Full Covered	23021	Mostly Covered
21036	Full Covered	21218	Full Covered	21717	Full Covered	22032	Full Covered	22249	Full Covered	23025	Mostly Covered
21037	Full Covered	21219	Mostly Covered	21718	Mostly Covered	22033	Full Covered	22250	Full Covered	23030	Full Covered
21040	Full Covered	21220	Full Covered	21720	Mostly Covered	22035	Full Covered	22251	Full Covered	23032	Mostly Covered
21041	Full Covered	21221	Full Covered	21721	Full Covered	22037	Full Covered	22252	Full Covered	23039	Mostly Covered
21042	Full Covered	21222	Full Covered	21723	Full Covered	22038	Full Covered	22253	Full Covered	23047	Mostly Covered
21043	Full Covered	21223	Full Covered	21733	Full Covered	22039	Full Covered	22254	Full Covered	23058	Full Covered
21044	Full Covered	21224	Full Covered	21734	Full Covered	22040	Full Covered	22258	Full Covered	23059	Full Covered
21045	Full Covered	21225	Full Covered	21737	Full Covered	22041	Full Covered	22259	Full Covered	23060	Full Covered
21046	Full Covered	21226	Full Covered	21738	Full Covered	22042	Full Covered	22310	Full Covered	23062	Full Covered
21047	Mostly Covered	21227	Full Covered	21740	Full Covered	22043	Full Covered	22311	Full Covered	23069	Full Covered
21048	Full Covered	21228	Full Covered	21741	Full Covered	22044	Full Covered	22312	Full Covered	23072	Full Covered
21050	Mostly Covered	21229	Full Covered	21742	Full Covered	22046	Full Covered	22313	Full Covered	23075	Full Covered
21051	Mostly Covered	21230	Full Covered	21746	Full Covered	22060	Full Covered	22314	Full Covered	23081	Full Covered
21052	Mostly Covered	21231	Full Covered	21747	Full Covered	22066	Full Covered	22315	Full Covered	23089	Mostly Covered
21054	Full Covered	21233	Full Covered	21748	Full Covered	22067	Full Covered	22320	Full Covered	23090	Full Covered
21055	Full Covered	21234	Full Covered	21749	Full Covered	22079	Full Covered	22331	Full Covered	23091	Mostly Covered
21056	Mostly Covered	21235	Full Covered	21754	Mostly Covered	22081	Full Covered	22332	Full Covered	23103	Full Covered
21057	Full Covered	21236	Full Covered	21755	Full Covered	22082	Full Covered	22333	Full Covered	23106	Mostly Covered
21060	Full Covered	21237	Full Covered	21756	Mostly Covered	22101	Full Covered	22334	Full Covered	23107	Full Covered
21061	Full Covered	21239	Full Covered	21758	Mostly Covered	22102	Full Covered	22336	Full Covered	23108	Full Covered
21062	Full Covered	21240	Full Covered	21762	Mostly Covered	22103	Full Covered	22401	Full Covered	23110	Full Covered
21065	Full Covered	21241	Full Covered	21765	Full Covered	22106	Full Covered	22402	Full Covered	23111	Mostly Covered
21071	Full Covered	21244	Full Covered	21767	Full Covered	22107	Full Covered	22403	Full Covered	23112	Full Covered
21074	Mostly Covered	21250	Full Covered	21769	Full Covered	22108	Full Covered	22404	Full Covered	23113	Full Covered
21075	Full Covered	21251	Full Covered	21770	Full Covered	22116	Full Covered	22405	Full Covered	23114	Full Covered
21076	Full Covered	21252	Full Covered	21771	Full Covered	22118	Full Covered	22406	Mostly Covered	23116	Full Covered
21077	Full Covered	21263	Full Covered	21773	Full Covered	22119	Full Covered	22407	Full Covered	23124	Full Covered
21078	Full Covered	21264	Full Covered	21774	Full Covered	22121	Full Covered	22408	Full Covered	23127	Full Covered
21082	Mostly Covered	21265	Full Covered	21776	Mostly Covered	22122	Full Covered	22412	Full Covered	23129	Mostly Covered
21085	Full Covered	21268	Full Covered	21777	Full Covered	22124	Full Covered	22430	Full Covered	23131	Full Covered
21087	Full Covered	21270	Full Covered	21779	Mostly Covered	22125	Full Covered	22446	Full Covered	23140	Full Covered
21088	Mostly Covered	21273	Full Covered	21780	Mostly Covered	22134	Mostly Covered	22448	Mostly Covered	23141	Full Covered
21090	Full Covered	21274	Full Covered	21781	Full Covered	22135	Full Covered	22463	Mostly Covered	23146	Full Covered
21092	Full Covered	21275	Full Covered	21782	Mostly Covered	22150	Full Covered	22471	Mostly Covered	23147	Full Covered
21093	Full Covered	21278	Full Covered	21783	Mostly Covered	22151	Full Covered	22546	Mostly Covered	23150	Mostly Covered
21094	Full Covered	21279	Full Covered	21784	Mostly Covered	22152	Full Covered	22547	Mostly Covered	23154	Mostly Covered
21098	Full Covered	21280	Full Covered	21788	Mostly Covered	22153	Full Covered	22554	Full Covered	23155	Mostly Covered
21102	Mostly Covered	21281	Full Covered	21790	Full Covered	22156	Full Covered	22555	Full Covered	23156	Full Covered
21104	Mostly Covered	21282	Full Covered	21792	Mostly Covered	22158	Full Covered	22556	Mostly Covered	23162	Full Covered
21106	Full Covered	21283	Full Covered	21793	Mostly Covered	22159	Full Covered	22565	Mostly Covered	23168	Full Covered
21108	Full Covered	21284	Full Covered	21794	Full Covered	22160	Full Covered	22580	Mostly Covered	23173	Full Covered
21111	Mostly Covered	21285	Full Covered	21795	Mostly Covered	22161	Full Covered	22611	Mostly Covered	23178	Mostly Covered
21113	Full Covered	21286	Full Covered	21797	Full Covered	22172	Full Covered	22620	Mostly Covered	23181	Full Covered
21114	Full Covered	21287	Full Covered	21801	Full Covered	22180	Full Covered	22646	Mostly Covered	23183	Full Covered
21117	Full Covered	21288	Full Covered	21802	Full Covered	22181	Full Covered	22712	Full Covered	23184	Full Covered
21120	Mostly Covered	21289	Full Covered	21803	Full Covered	22182	Full Covered	22714	Mostly Covered	23185	Full Covered
21122	Full Covered	21290	Full Covered	21804	Full Covered	22183	Full Covered	22724	Mostly Covered	23186	Full Covered

Zip Code	Coverage Level	Zip Code	Coverage Level	Zip Code	Coverage Level	Zip Code	Coverage Level	Zip Code	Coverage Level	Zip Code	Coverage Level
23187	Full Covered	23453	Full Covered	23804	Full Covered	24502	Full Covered	25712	Full Covered	27108	Full Covered
23188	Full Covered	23454	Full Covered	23805	Full Covered	24503	Mostly Covered	25713	Full Covered	27109	Full Covered
23190	Mostly Covered	23455	Full Covered	23806	Full Covered	24504	Full Covered	25714	Full Covered	27110	Full Covered
23191	Mostly Covered	23456	Mostly Covered	23831	Full Covered	24505	Full Covered	25715	Full Covered	27111	Full Covered
23192	Mostly Covered	23458	Full Covered	23832	Full Covered	24506	Full Covered	25716	Full Covered	27113	Full Covered
23218	Full Covered	23459	Full Covered	23833	Mostly Covered	24512	Full Covered	25717	Full Covered	27114	Full Covered
23219	Full Covered	23460	Full Covered	23834	Full Covered	24513	Full Covered	25718	Full Covered	27115	Full Covered
23220	Full Covered	23461	Full Covered	23836	Full Covered	24514	Full Covered	25719	Full Covered	27116	Full Covered
23221	Full Covered	23462	Full Covered	23838	Mostly Covered	24515	Full Covered	25720	Full Covered	27117	Full Covered
23222	Full Covered	23463	Full Covered	23842	Full Covered	24550	Mostly Covered	25721	Full Covered	27120	Full Covered
23223	Full Covered	23464	Full Covered	23860	Full Covered	24551	Mostly Covered	25722	Full Covered	27127	Full Covered
23224	Full Covered	23465	Full Covered	23875	Full Covered	24572	Mostly Covered	25723	Full Covered	27130	Full Covered
23225	Full Covered	23466	Full Covered	23883	Mostly Covered	24588	Full Covered	25724	Full Covered	27150	Full Covered
23226	Full Covered	23467	Full Covered	23885	Full Covered	25003	Mostly Covered	25725	Full Covered	27151	Full Covered
23227	Full Covered	23471	Full Covered	24001	Full Covered	25009	Mostly Covered	25726	Full Covered	27155	Full Covered
23228	Full Covered	23479	Full Covered	24002	Full Covered	25064	Full Covered	25727	Full Covered	27156	Full Covered
23229	Full Covered	23487	Mostly Covered	24003	Full Covered	25112	Mostly Covered	25728	Full Covered	27157	Full Covered
23230	Full Covered	23501	Full Covered	24004	Full Covered	25143	Mostly Covered	25729	Full Covered	27201	Full Covered
23231	Full Covered	23502	Full Covered	24005	Full Covered	25156	Mostly Covered	25755	Full Covered	27202	Full Covered
23232	Full Covered	23503	Full Covered	24006	Full Covered	25201	Mostly Covered	25770	Full Covered	27203	Full Covered
23233	Full Covered	23504	Full Covered	24007	Full Covered	25301	Full Covered	25771	Full Covered	27204	Full Covered
23234	Full Covered	23505	Full Covered	24008	Full Covered	25302	Full Covered	25772	Full Covered	27205	Full Covered
23235	Full Covered	23506	Full Covered	24009	Full Covered	25303	Full Covered	25773	Full Covered	27214	Full Covered
23236	Full Covered	23507	Full Covered	24010	Full Covered	25304	Full Covered	25774	Full Covered	27215	Full Covered
23237	Full Covered	23508	Full Covered	24011	Full Covered	25305	Full Covered	25775	Full Covered	27216	Full Covered
23238	Full Covered	23509	Full Covered	24012	Full Covered	25306	Mostly Covered	25776	Full Covered	27217	Mostly Covered
23240	Full Covered	23510	Full Covered	24013	Full Covered	25309	Full Covered	25777	Full Covered	27228	Full Covered
23241	Full Covered	23511	Full Covered	24014	Full Covered	25311	Full Covered	25778	Full Covered	27230	Full Covered
23242	Full Covered	23512	Full Covered	24015	Full Covered	25312	Full Covered	25779	Full Covered	27231	Mostly Covered
23249	Full Covered	23513	Full Covered	24016	Full Covered	25313	Full Covered	26003	Full Covered	27235	Full Covered
23250	Full Covered	23514	Full Covered	24017	Full Covered	25314	Full Covered	26030	Full Covered	27243	Full Covered
23255	Full Covered	23515	Full Covered	24018	Mostly Covered	25315	Mostly Covered	26031	Full Covered	27244	Mostly Covered
23260	Full Covered	23517	Full Covered	24019	Full Covered	25317	Full Covered	26032	Mostly Covered	27248	Full Covered
23261	Full Covered	23518	Full Covered	24020	Full Covered	25320	Mostly Covered	26035	Full Covered	27249	Full Covered
23269	Full Covered	23519	Full Covered	24022	Full Covered	25321	Full Covered	26036	Mostly Covered	27253	Full Covered
23270	Full Covered	23520	Full Covered	24023	Full Covered	25322	Full Covered	26037	Full Covered	27258	Full Covered
23272	Full Covered	23521	Full Covered	24024	Full Covered	25323	Full Covered	26038	Full Covered	27260	Full Covered
23273	Full Covered	23523	Full Covered	24025	Full Covered	25324	Full Covered	26040	Full Covered	27261	Full Covered
23274	Full Covered	23529	Full Covered	24026	Full Covered	25325	Full Covered	26041	Mostly Covered	27262	Full Covered
23275	Full Covered	23530	Full Covered	24027	Full Covered	25326	Full Covered	26047	Mostly Covered	27263	Full Covered
23276	Full Covered	23541	Full Covered	24028	Full Covered	25327	Full Covered	26058	Full Covered	27264	Full Covered
23278	Full Covered	23551	Full Covered	24029	Full Covered	25328	Full Covered	26059	Mostly Covered	27265	Full Covered
23279	Full Covered	23601	Full Covered	24030	Full Covered	25329	Full Covered	26060	Mostly Covered	27278	Full Covered
23280	Full Covered	23602	Full Covered	24031	Full Covered	25330	Full Covered	26062	Full Covered	27281	Mostly Covered
23282	Full Covered	23603	Full Covered	24032	Full Covered	25331	Full Covered	26070	Full Covered	27282	Full Covered
23284	Full Covered	23604	Full Covered	24033	Full Covered	25332	Full Covered	26074	Mostly Covered	27283	Mostly Covered
23285	Full Covered	23605	Full Covered	24034	Full Covered	25333	Full Covered	26075	Full Covered	27284	Full Covered
23286	Full Covered	23606	Full Covered	24035	Full Covered	25334	Full Covered	26101	Mostly Covered	27285	Full Covered
23288	Full Covered	23607	Full Covered	24036	Full Covered	25335	Full Covered	26102	Full Covered	27288	Mostly Covered
23289	Full Covered	23608	Full Covered	24037	Full Covered	25336	Full Covered	26103	Full Covered	27289	Mostly Covered
23290	Full Covered	23609	Full Covered	24038	Full Covered	25337	Full Covered	26104	Full Covered	27293	Full Covered
23291	Full Covered	23612	Full Covered	24040	Full Covered	25338	Full Covered	26105	Full Covered	27294	Full Covered
23292	Full Covered	23628	Full Covered	24042	Full Covered	25339	Full Covered	26106	Full Covered	27295	Full Covered
23293	Full Covered	23630	Full Covered	24044	Full Covered	25350	Full Covered	26120	Mostly Covered	27299	Mostly Covered
23294	Full Covered	23631	Full Covered	24048	Full Covered	25356	Mostly Covered	26121	Mostly Covered	27301	Full Covered
23295	Full Covered	23651	Full Covered	24050	Full Covered	25357	Full Covered	26142	Mostly Covered	27302	Mostly Covered
23297	Full Covered	23653	Full Covered	24064	Mostly Covered	25358	Full Covered	26150	Mostly Covered	27310	Full Covered
23298	Full Covered	23661	Full Covered	24065	Mostly Covered	25360	Full Covered	26184	Mostly Covered	27312	Mostly Covered
23304	Full Covered	23662	Full Covered	24077	Full Covered	25361	Full Covered	26187	Full Covered	27313	Mostly Covered
23314	Full Covered	23663	Full Covered	24083	Full Covered	25362	Mostly Covered	27006	Mostly Covered	27317	Full Covered
23320	Full Covered	23664	Full Covered	24084	Mostly Covered	25364	Full Covered	27009	Full Covered	27320	Full Covered
23321	Full Covered	23665	Full Covered	24090	Mostly Covered	25365	Mostly Covered	27010	Mostly Covered	27323	Full Covered
23322	Full Covered	23666	Full Covered	24101	Mostly Covered	25375	Full Covered	27012	Full Covered	27326	Mostly Covered
23323	Mostly Covered	23667	Full Covered	24126	Full Covered	25387	Full Covered	27016	Mostly Covered	27340	Full Covered
23324	Full Covered	23668	Full Covered	24153	Mostly Covered	25389	Full Covered	27019	Mostly Covered	27342	Full Covered
23325	Full Covered	23669	Full Covered	24155	Mostly Covered	25392	Full Covered	27021	Full Covered	27349	Mostly Covered
23326	Full Covered	23670	Full Covered	24156	Full Covered	25396	Full Covered	27025	Mostly Covered	27350	Full Covered
23327	Full Covered	23681	Full Covered	24175	Full Covered	25414	Mostly Covered	27040	Mostly Covered	27357	Full Covered
23328	Full Covered	23690	Full Covered	24178	Mostly Covered	25419	Mostly Covered	27041	Mostly Covered	27358	Full Covered
23397	Mostly Covered	23691	Full Covered	24179	Mostly Covered	25441	Mostly Covered	27043	Full Covered	27359	Full Covered
23424	Full Covered	23692	Full Covered	24201	Mostly Covered	25507	Full Covered	27045	Mostly Covered	27360	Mostly Covered
23430	Full Covered	23693	Full Covered	24203	Mostly Covered	25530	Full Covered	27050	Mostly Covered	27361	Mostly Covered
23431	Full Covered	23694	Full Covered	24209	Mostly Covered	25535	Mostly Covered	27051	Mostly Covered	27370	Mostly Covered
23432	Full Covered	23696	Full Covered	24251	Mostly Covered	25562	Full Covered	27053	Full Covered	27373	Mostly Covered
23433	Full Covered	23701	Full Covered	24290	Full Covered	25701	Mostly Covered	27094	Mostly Covered	27374	Full Covered
23434	Full Covered	23702	Full Covered	24301	Full Covered	25703	Full Covered	27098	Mostly Covered	27375	Full Covered
23435	Full Covered	23703	Full Covered	24313	Mostly Covered	25704	Full Covered	27099	Mostly Covered	27376	Mostly Covered
23436	Full Covered	23704	Full Covered	24324	Full Covered	25705	Mostly Covered	27101	Full Covered	27377	Full Covered
23437	Mostly Covered	23705	Full Covered	24347	Full Covered	25706	Full Covered	27102	Full Covered	27401	Full Covered
23438	Mostly Covered	23707	Full Covered	24360	Mostly Covered	25707	Full Covered	27103	Full Covered	27402	Full Covered
23439	Full Covered	23708	Full Covered	24467	Mostly Covered	25708	Full Covered	27104	Full Covered	27403	Full Covered
23450	Full Covered	23709	Full Covered	24471	Mostly Covered	25709	Full Covered	27105	Full Covered	27404	Full Covered
23451	Full Covered	23801	Full Covered	24486	Mostly Covered	25710	Full Covered	27106	Full Covered	27405	Full Covered
23452	Full Covered	23803	Full Covered	24501	Full Covered	25711	Full Covered	27107	Full Covered	27406	Full Covered

Zip Code	Coverage Level	Zip Code	Coverage Level	Zip Code	Coverage Level	Zip Code	Coverage Level	Zip Code	Coverage Level	Zip Code	Coverage Level
27407	Full Covered	27615	Full Covered	28023	Full Covered	28211	Full Covered	28343	Full Covered	28625	Full Covered
27408	Full Covered	27616	Full Covered	28024	Mostly Covered	28212	Full Covered	28344	Mostly Covered	28628	Full Covered
27409	Full Covered	27617	Full Covered	28025	Full Covered	28213	Full Covered	28345	Mostly Covered	28630	Mostly Covered
27410	Full Covered	27619	Full Covered	28026	Full Covered	28214	Full Covered	28347	Mostly Covered	28636	Full Covered
27411	Full Covered	27620	Full Covered	28027	Mostly Covered	28215	Full Covered	28348	Mostly Covered	28637	Full Covered
27412	Full Covered	27621	Full Covered	28031	Full Covered	28216	Full Covered	28351	Mostly Covered	28650	Full Covered
27413	Full Covered	27622	Full Covered	28032	Full Covered	28217	Full Covered	28352	Full Covered	28654	Full Covered
27415	Full Covered	27623	Full Covered	28034	Full Covered	28218	Full Covered	28353	Full Covered	28655	Full Covered
27416	Full Covered	27624	Full Covered	28035	Full Covered	28219	Full Covered	28356	Mostly Covered	28656	Mostly Covered
27417	Full Covered	27625	Full Covered	28036	Full Covered	28220	Full Covered	28358	Full Covered	28658	Full Covered
27419	Full Covered	27626	Full Covered	28037	Full Covered	28221	Full Covered	28359	Full Covered	28659	Mostly Covered
27420	Full Covered	27627	Full Covered	28038	Full Covered	28222	Full Covered	28360	Full Covered	28660	Mostly Covered
27425	Full Covered	27628	Full Covered	28039	Full Covered	28223	Full Covered	28361	Mostly Covered	28666	Mostly Covered
27427	Full Covered	27629	Full Covered	28040	Full Covered	28224	Full Covered	28363	Mostly Covered	28667	Full Covered
27429	Full Covered	27634	Full Covered	28041	Full Covered	28226	Full Covered	28364	Mostly Covered	28673	Full Covered
27435	Full Covered	27635	Full Covered	28042	Mostly Covered	28227	Full Covered	28370	Full Covered	28677	Full Covered
27438	Full Covered	27636	Full Covered	28043	Mostly Covered	28228	Full Covered	28371	Mostly Covered	28678	Mostly Covered
27455	Full Covered	27640	Full Covered	28052	Full Covered	28229	Full Covered	28372	Mostly Covered	28680	Mostly Covered
27495	Full Covered	27650	Full Covered	28053	Full Covered	28230	Full Covered	28373	Full Covered	28681	Mostly Covered
27498	Full Covered	27656	Full Covered	28054	Full Covered	28231	Full Covered	28374	Full Covered	28682	Mostly Covered
27501	Mostly Covered	27658	Full Covered	28055	Full Covered	28232	Full Covered	28379	Full Covered	28687	Full Covered
27502	Full Covered	27661	Full Covered	28056	Full Covered	28233	Full Covered	28380	Full Covered	28688	Mostly Covered
27503	Mostly Covered	27668	Full Covered	28070	Full Covered	28234	Full Covered	28384	Mostly Covered	28689	Full Covered
27504	Mostly Covered	27675	Full Covered	28071	Mostly Covered	28235	Full Covered	28387	Full Covered	28690	Mostly Covered
27506	Mostly Covered	27676	Full Covered	28072	Full Covered	28236	Full Covered	28388	Full Covered	28697	Full Covered
27510	Full Covered	27690	Full Covered	28073	Full Covered	28237	Full Covered	28390	Mostly Covered	28699	Full Covered
27511	Full Covered	27695	Full Covered	28075	Full Covered	28240	Full Covered	28391	Full Covered	28701	Full Covered
27512	Full Covered	27697	Full Covered	28076	Mostly Covered	28241	Full Covered	28395	Mostly Covered	28704	Mostly Covered
27513	Full Covered	27698	Full Covered	28077	Mostly Covered	28242	Full Covered	28396	Mostly Covered	28712	Full Covered
27514	Full Covered	27699	Full Covered	28078	Full Covered	28243	Full Covered	28401	Full Covered	28715	Full Covered
27515	Full Covered	27701	Full Covered	28079	Full Covered	28244	Full Covered	28402	Full Covered	28716	Mostly Covered
27516	Full Covered	27702	Full Covered	28080	Full Covered	28246	Full Covered	28403	Full Covered	28718	Full Covered
27517	Full Covered	27703	Full Covered	28081	Mostly Covered	28247	Full Covered	28404	Mostly Covered	28720	Mostly Covered
27518	Full Covered	27704	Full Covered	28082	Full Covered	28253	Full Covered	28405	Full Covered	28721	Full Covered
27519	Full Covered	27705	Full Covered	28083	Full Covered	28254	Full Covered	28406	Full Covered	28722	Mostly Covered
27520	Mostly Covered	27707	Full Covered	28086	Full Covered	28256	Full Covered	28407	Full Covered	28724	Full Covered
27521	Full Covered	27708	Full Covered	28088	Full Covered	28258	Full Covered	28408	Full Covered	28725	Full Covered
27523	Mostly Covered	27709	Full Covered	28089	Mostly Covered	28260	Full Covered	28409	Full Covered	28726	Full Covered
27524	Full Covered	27710	Full Covered	28090	Mostly Covered	28261	Full Covered	28412	Full Covered	28727	Mostly Covered
27525	Mostly Covered	27711	Full Covered	28091	Mostly Covered	28262	Full Covered	28420	Mostly Covered	28728	Full Covered
27526	Mostly Covered	27712	Full Covered	28098	Full Covered	28265	Full Covered	28428	Mostly Covered	28729	Full Covered
27529	Mostly Covered	27713	Full Covered	28101	Full Covered	28266	Full Covered	28429	Mostly Covered	28731	Full Covered
27530	Full Covered	27715	Full Covered	28104	Full Covered	28269	Full Covered	28459	Full Covered	28732	Full Covered
27531	Full Covered	27717	Full Covered	28105	Full Covered	28270	Full Covered	28462	Full Covered	28734	Mostly Covered
27532	Full Covered	27722	Full Covered	28106	Full Covered	28271	Full Covered	28468	Mostly Covered	28738	Full Covered
27533	Full Covered	27801	Full Covered	28108	Mostly Covered	28272	Full Covered	28469	Full Covered	28739	Full Covered
27534	Full Covered	27802	Full Covered	28110	Full Covered	28273	Full Covered	28470	Full Covered	28742	Mostly Covered
27536	Mostly Covered	27803	Full Covered	28111	Full Covered	28274	Full Covered	28479	Mostly Covered	28744	Mostly Covered
27537	Mostly Covered	27804	Full Covered	28112	Full Covered	28275	Full Covered	28480	Mostly Covered	28745	Full Covered
27539	Full Covered	27807	Full Covered	28114	Mostly Covered	28277	Full Covered	28501	Full Covered	28748	Full Covered
27540	Full Covered	27809	Mostly Covered	28115	Mostly Covered	28278	Full Covered	28502	Full Covered	28750	Full Covered
27542	Mostly Covered	27811	Full Covered	28117	Mostly Covered	28280	Full Covered	28503	Full Covered	28753	Mostly Covered
27543	Mostly Covered	27813	Mostly Covered	28120	Full Covered	28281	Full Covered	28504	Full Covered	28756	Full Covered
27544	Full Covered	27822	Full Covered	28123	Full Covered	28282	Full Covered	28512	Full Covered	28758	Full Covered
27545	Full Covered	27827	Mostly Covered	28124	Mostly Covered	28283	Full Covered	28513	Mostly Covered	28760	Full Covered
27557	Full Covered	27828	Mostly Covered	28126	Full Covered	28284	Full Covered	28519	Full Covered	28766	Full Covered
27560	Full Covered	27833	Full Covered	28130	Full Covered	28285	Full Covered	28525	Mostly Covered	28768	Full Covered
27562	Mostly Covered	27834	Full Covered	28134	Full Covered	28287	Full Covered	28527	Mostly Covered	28773	Full Covered
27569	Mostly Covered	27835	Full Covered	28136	Mostly Covered	28289	Full Covered	28538	Mostly Covered	28776	Mostly Covered
27571	Full Covered	27836	Full Covered	28138	Full Covered	28290	Full Covered	28540	Full Covered	28779	Mostly Covered
27576	Mostly Covered	27858	Mostly Covered	28144	Full Covered	28296	Full Covered	28541	Full Covered	28782	Full Covered
27577	Full Covered	27863	Full Covered	28145	Full Covered	28297	Full Covered	28542	Mostly Covered	28784	Mostly Covered
27587	Full Covered	27864	Full Covered	28146	Full Covered	28299	Full Covered	28543	Full Covered	28785	Full Covered
27588	Full Covered	27878	Full Covered	28147	Mostly Covered	28301	Full Covered	28544	Mostly Covered	28786	Mostly Covered
27591	Full Covered	27879	Mostly Covered	28150	Full Covered	28302	Full Covered	28545	Full Covered	28787	Mostly Covered
27592	Full Covered	27880	Full Covered	28151	Full Covered	28303	Full Covered	28546	Full Covered	28788	Mostly Covered
27593	Full Covered	27883	Mostly Covered	28152	Full Covered	28304	Full Covered	28547	Mostly Covered	28789	Mostly Covered
27596	Full Covered	27893	Full Covered	28159	Full Covered	28305	Full Covered	28554	Mostly Covered	28790	Mostly Covered
27597	Full Covered	27894	Full Covered	28160	Mostly Covered	28306	Full Covered	28557	Full Covered	28791	Full Covered
27599	Full Covered	27895	Full Covered	28164	Mostly Covered	28307	Full Covered	28560	Full Covered	28792	Mostly Covered
27601	Full Covered	27896	Full Covered	28166	Full Covered	28308	Full Covered	28561	Full Covered	28793	Full Covered
27602	Full Covered	27948	Mostly Covered	28169	Full Covered	28309	Full Covered	28562	Full Covered	28801	Full Covered
27603	Full Covered	27954	Full Covered	28173	Mostly Covered	28311	Full Covered	28563	Full Covered	28802	Full Covered
27604	Full Covered	27968	Full Covered	28174	Full Covered	28312	Full Covered	28564	Full Covered	28803	Mostly Covered
27605	Full Covered	27981	Full Covered	28201	Full Covered	28314	Full Covered	28575	Mostly Covered	28804	Full Covered
27606	Full Covered	28006	Mostly Covered	28202	Full Covered	28315	Full Covered	28590	Full Covered	28805	Mostly Covered
27607	Full Covered	28010	Full Covered	28203	Full Covered	28330	Full Covered	28601	Full Covered	28806	Full Covered
27608	Full Covered	28012	Full Covered	28204	Full Covered	28331	Full Covered	28602	Full Covered	28810	Full Covered
27609	Full Covered	28016	Full Covered	28205	Full Covered	28333	Full Covered	28603	Full Covered	28813	Mostly Covered
27610	Full Covered	28017	Mostly Covered	28206	Full Covered	28334	Full Covered	28606	Mostly Covered	28814	Full Covered
27611	Full Covered	28018	Full Covered	28207	Full Covered	28335	Full Covered	28609	Full Covered	28815	Mostly Covered
27612	Full Covered	28019	Mostly Covered	28208	Full Covered	28338	Mostly Covered	28610	Mostly Covered	28816	Full Covered
27613	Full Covered	28020	Mostly Covered	28209	Full Covered	28339	Full Covered	28613	Mostly Covered	29002	Full Covered
27614	Full Covered	28021	Mostly Covered	28210	Full Covered	28342	Full Covered	28619	Mostly Covered	29016	Full Covered

Zip Code	Coverage Level	Zip Code	Coverage Level	Zip Code	Coverage Level	Zip Code	Coverage Level	Zip Code	Coverage Level	Zip Code	Coverage Level
29018	Mostly Covered	29324	Mostly Covered	29485	Full Covered	29684	Mostly Covered	30039	Full Covered	30147	Full Covered
29020	Mostly Covered	29325	Full Covered	29487	Full Covered	29687	Full Covered	30040	Full Covered	30148	Full Covered
29033	Full Covered	29329	Full Covered	29488	Mostly Covered	29688	Mostly Covered	30041	Full Covered	30149	Full Covered
29036	Mostly Covered	29330	Mostly Covered	29492	Full Covered	29690	Mostly Covered	30042	Full Covered	30150	Mostly Covered
29038	Mostly Covered	29331	Mostly Covered	29501	Full Covered	29691	Mostly Covered	30043	Full Covered	30151	Mostly Covered
29039	Full Covered	29332	Mostly Covered	29502	Full Covered	29693	Mostly Covered	30044	Full Covered	30152	Full Covered
29045	Full Covered	29333	Full Covered	29503	Full Covered	29695	Mostly Covered	30045	Full Covered	30154	Full Covered
29051	Mostly Covered	29334	Full Covered	29504	Full Covered	29696	Full Covered	30046	Full Covered	30156	Full Covered
29053	Mostly Covered	29335	Mostly Covered	29505	Full Covered	29697	Mostly Covered	30047	Full Covered	30157	Full Covered
29059	Mostly Covered	29336	Full Covered	29506	Mostly Covered	29698	Full Covered	30048	Full Covered	30160	Full Covered
29061	Mostly Covered	29340	Mostly Covered	29526	Mostly Covered	29702	Mostly Covered	30049	Full Covered	30161	Full Covered
29062	Mostly Covered	29341	Full Covered	29528	Mostly Covered	29703	Full Covered	30052	Mostly Covered	30162	Full Covered
29063	Full Covered	29342	Full Covered	29530	Mostly Covered	29704	Mostly Covered	30054	Full Covered	30163	Full Covered
29071	Full Covered	29346	Full Covered	29532	Mostly Covered	29708	Full Covered	30055	Mostly Covered	30164	Full Covered
29072	Full Covered	29348	Full Covered	29541	Full Covered	29710	Full Covered	30058	Full Covered	30165	Full Covered
29073	Mostly Covered	29349	Full Covered	29568	Mostly Covered	29712	Mostly Covered	30060	Full Covered	30168	Full Covered
29078	Full Covered	29351	Full Covered	29570	Mostly Covered	29715	Full Covered	30061	Full Covered	30169	Full Covered
29104	Mostly Covered	29355	Mostly Covered	29572	Full Covered	29716	Full Covered	30062	Full Covered	30171	Mostly Covered
29115	Full Covered	29356	Full Covered	29575	Full Covered	29724	Mostly Covered	30064	Full Covered	30173	Mostly Covered
29116	Full Covered	29360	Mostly Covered	29576	Full Covered	29730	Full Covered	30065	Full Covered	30177	Full Covered
29117	Full Covered	29365	Full Covered	29577	Full Covered	29731	Full Covered	30066	Full Covered	30180	Mostly Covered
29118	Full Covered	29368	Mostly Covered	29578	Full Covered	29732	Full Covered	30067	Full Covered	30183	Full Covered
29130	Mostly Covered	29369	Full Covered	29579	Full Covered	29734	Full Covered	30068	Full Covered	30184	Full Covered
29132	Full Covered	29370	Mostly Covered	29585	Mostly Covered	29743	Mostly Covered	30069	Full Covered	30185	Full Covered
29133	Mostly Covered	29374	Mostly Covered	29588	Full Covered	29745	Full Covered	30070	Full Covered	30187	Full Covered
29135	Full Covered	29375	Mostly Covered	29594	Mostly Covered	29801	Full Covered	30071	Full Covered	30188	Full Covered
29147	Full Covered	29376	Full Covered	29598	Mostly Covered	29802	Full Covered	30072	Full Covered	30189	Full Covered
29150	Full Covered	29377	Full Covered	29601	Full Covered	29803	Mostly Covered	30074	Full Covered	30205	Mostly Covered
29151	Full Covered	29378	Full Covered	29602	Full Covered	29804	Full Covered	30075	Full Covered	30212	Full Covered
29153	Full Covered	29384	Mostly Covered	29603	Full Covered	29805	Full Covered	30076	Full Covered	30213	Full Covered
29154	Mostly Covered	29385	Full Covered	29604	Full Covered	29809	Mostly Covered	30077	Full Covered	30214	Full Covered
29160	Mostly Covered	29386	Mostly Covered	29605	Full Covered	29819	Full Covered	30078	Full Covered	30215	Mostly Covered
29169	Full Covered	29390	Full Covered	29606	Full Covered	29822	Full Covered	30079	Full Covered	30220	Mostly Covered
29170	Full Covered	29391	Full Covered	29607	Full Covered	29828	Full Covered	30080	Full Covered	30223	Full Covered
29171	Full Covered	29401	Full Covered	29608	Full Covered	29829	Full Covered	30081	Full Covered	30224	Mostly Covered
29172	Full Covered	29402	Full Covered	29609	Full Covered	29834	Full Covered	30082	Full Covered	30228	Full Covered
29177	Full Covered	29403	Full Covered	29610	Full Covered	29839	Full Covered	30083	Full Covered	30229	Mostly Covered
29180	Full Covered	29404	Full Covered	29611	Full Covered	29841	Full Covered	30084	Full Covered	30230	Mostly Covered
29201	Full Covered	29405	Full Covered	29612	Full Covered	29842	Full Covered	30085	Full Covered	30232	Mostly Covered
29202	Full Covered	29406	Full Covered	29613	Full Covered	29850	Full Covered	30086	Full Covered	30233	Mostly Covered
29203	Full Covered	29407	Full Covered	29614	Full Covered	29851	Full Covered	30087	Full Covered	30234	Full Covered
29204	Full Covered	29409	Full Covered	29615	Full Covered	29860	Mostly Covered	30088	Full Covered	30236	Full Covered
29205	Full Covered	29410	Full Covered	29616	Full Covered	29861	Full Covered	30090	Full Covered	30237	Full Covered
29206	Full Covered	29412	Full Covered	29617	Full Covered	29910	Mostly Covered	30091	Full Covered	30238	Full Covered
29207	Full Covered	29413	Full Covered	29621	Full Covered	29915	Full Covered	30092	Full Covered	30240	Full Covered
29208	Full Covered	29414	Full Covered	29622	Full Covered	29925	Full Covered	30093	Full Covered	30241	Full Covered
29209	Mostly Covered	29415	Full Covered	29623	Full Covered	29926	Full Covered	30094	Full Covered	30248	Full Covered
29210	Full Covered	29416	Full Covered	29624	Full Covered	29928	Full Covered	30095	Full Covered	30250	Full Covered
29211	Full Covered	29417	Full Covered	29625	Full Covered	29938	Full Covered	30096	Full Covered	30252	Full Covered
29212	Full Covered	29418	Full Covered	29626	Mostly Covered	30002	Full Covered	30097	Full Covered	30253	Full Covered
29214	Full Covered	29419	Full Covered	29627	Mostly Covered	30003	Full Covered	30098	Full Covered	30257	Mostly Covered
29215	Full Covered	29420	Full Covered	29630	Mostly Covered	30004	Full Covered	30099	Full Covered	30259	Mostly Covered
29216	Full Covered	29422	Full Covered	29631	Mostly Covered	30005	Full Covered	30101	Full Covered	30260	Full Covered
29217	Full Covered	29423	Full Covered	29632	Mostly Covered	30006	Full Covered	30102	Full Covered	30261	Mostly Covered
29218	Full Covered	29424	Full Covered	29633	Mostly Covered	30007	Full Covered	30106	Full Covered	30263	Full Covered
29219	Full Covered	29425	Full Covered	29634	Mostly Covered	30008	Full Covered	30107	Mostly Covered	30264	Full Covered
29220	Full Covered	29431	Mostly Covered	29635	Mostly Covered	30009	Full Covered	30109	Full Covered	30265	Full Covered
29221	Full Covered	29434	Mostly Covered	29636	Full Covered	30010	Full Covered	30110	Mostly Covered	30266	Mostly Covered
29222	Full Covered	29435	Mostly Covered	29640	Mostly Covered	30011	Full Covered	30111	Full Covered	30268	Full Covered
29223	Full Covered	29437	Mostly Covered	29643	Mostly Covered	30012	Mostly Covered	30112	Full Covered	30269	Full Covered
29224	Full Covered	29439	Full Covered	29644	Mostly Covered	30013	Full Covered	30114	Full Covered	30270	Full Covered
29225	Full Covered	29440	Full Covered	29646	Full Covered	30014	Full Covered	30115	Mostly Covered	30271	Full Covered
29226	Full Covered	29442	Full Covered	29647	Mostly Covered	30015	Full Covered	30116	Full Covered	30272	Full Covered
29227	Full Covered	29445	Full Covered	29648	Full Covered	30016	Full Covered	30117	Full Covered	30273	Full Covered
29228	Full Covered	29447	Mostly Covered	29649	Full Covered	30017	Full Covered	30118	Full Covered	30274	Full Covered
29229	Full Covered	29448	Full Covered	29650	Full Covered	30018	Full Covered	30119	Full Covered	30275	Full Covered
29230	Full Covered	29451	Full Covered	29651	Full Covered	30019	Full Covered	30120	Full Covered	30276	Full Covered
29240	Full Covered	29452	Full Covered	29652	Full Covered	30021	Full Covered	30121	Full Covered	30277	Full Covered
29250	Full Covered	29455	Full Covered	29656	Full Covered	30022	Full Covered	30122	Full Covered	30281	Full Covered
29260	Full Covered	29456	Full Covered	29657	Mostly Covered	30023	Full Covered	30123	Full Covered	30284	Full Covered
29290	Full Covered	29457	Full Covered	29661	Mostly Covered	30024	Full Covered	30124	Mostly Covered	30287	Full Covered
29292	Full Covered	29461	Full Covered	29662	Full Covered	30025	Full Covered	30126	Full Covered	30288	Full Covered
29301	Full Covered	29464	Full Covered	29665	Full Covered	30026	Full Covered	30127	Full Covered	30289	Full Covered
29302	Full Covered	29465	Full Covered	29666	Full Covered	30028	Full Covered	30129	Full Covered	30290	Full Covered
29303	Full Covered	29466	Full Covered	29667	Mostly Covered	30029	Full Covered	30132	Full Covered	30291	Full Covered
29304	Full Covered	29469	Full Covered	29670	Full Covered	30030	Full Covered	30133	Full Covered	30294	Full Covered
29305	Full Covered	29470	Mostly Covered	29672	Full Covered	30031	Full Covered	30134	Full Covered	30296	Full Covered
29306	Full Covered	29471	Mostly Covered	29675	Full Covered	30032	Full Covered	30135	Full Covered	30297	Full Covered
29307	Full Covered	29472	Mostly Covered	29677	Full Covered	30033	Full Covered	30137	Full Covered	30298	Full Covered
29316	Full Covered	29474	Full Covered	29678	Full Covered	30034	Full Covered	30141	Full Covered	30301	Full Covered
29318	Full Covered	29477	Full Covered	29679	Full Covered	30035	Full Covered	30142	Full Covered	30302	Full Covered
29319	Full Covered	29482	Full Covered	29680	Full Covered	30036	Full Covered	30143	Mostly Covered	30303	Full Covered
29320	Full Covered	29483	Full Covered	29681	Full Covered	30037	Full Covered	30144	Full Covered	30304	Full Covered
29322	Mostly Covered	29484	Full Covered	29683	Mostly Covered	30038	Mostly Covered	30146	Full Covered	30305	Full Covered

Zip Code	Coverage Level	Zip Code	Coverage Level	Zip Code	Coverage Level	Zip Code	Coverage Level	Zip Code	Coverage Level	Zip Code	Coverage Level
30306	Full Covered	30460	Full Covered	30911	Full Covered	31411	Mostly Covered	32034	Full Covered	32215	Mostly Covered
30307	Full Covered	30461	Full Covered	30912	Full Covered	31412	Full Covered	32035	Full Covered	32216	Full Covered
30308	Full Covered	30501	Full Covered	30914	Full Covered	31414	Full Covered	32040	Full Covered	32217	Full Covered
30309	Full Covered	30502	Full Covered	30916	Full Covered	31415	Full Covered	32041	Full Covered	32218	Full Covered
30310	Full Covered	30503	Full Covered	30917	Full Covered	31416	Full Covered	32042	Full Covered	32219	Full Covered
30311	Full Covered	30504	Full Covered	30919	Full Covered	31418	Full Covered	32043	Full Covered	32220	Full Covered
30312	Full Covered	30506	Full Covered	30999	Full Covered	31419	Mostly Covered	32044	Full Covered	32221	Full Covered
30313	Full Covered	30507	Full Covered	31004	Full Covered	31420	Full Covered	32050	Full Covered	32222	Mostly Covered
30314	Full Covered	30515	Full Covered	31005	Mostly Covered	31421	Full Covered	32056	Full Covered	32223	Full Covered
30315	Full Covered	30517	Full Covered	31008	Mostly Covered	31422	Full Covered	32061	Mostly Covered	32224	Full Covered
30316	Full Covered	30518	Full Covered	31019	Mostly Covered	31501	Full Covered	32063	Full Covered	32225	Full Covered
30317	Full Covered	30519	Full Covered	31021	Full Covered	31502	Full Covered	32065	Full Covered	32226	Full Covered
30318	Full Covered	30527	Mostly Covered	31022	Mostly Covered	31503	Full Covered	32067	Full Covered	32227	Full Covered
30319	Full Covered	30542	Full Covered	31027	Mostly Covered	31516	Mostly Covered	32068	Full Covered	32228	Full Covered
30320	Full Covered	30543	Mostly Covered	31028	Full Covered	31520	Full Covered	32073	Full Covered	32229	Full Covered
30321	Full Covered	30548	Full Covered	31029	Full Covered	31521	Full Covered	32079	Full Covered	32231	Full Covered
30322	Full Covered	30554	Mostly Covered	31034	Full Covered	31522	Mostly Covered	32080	Full Covered	32232	Full Covered
30324	Full Covered	30564	Mostly Covered	31040	Full Covered	31523	Mostly Covered	32082	Mostly Covered	32233	Full Covered
30325	Full Covered	30565	Mostly Covered	31046	Full Covered	31524	Full Covered	32084	Full Covered	32234	Mostly Covered
30326	Full Covered	30566	Mostly Covered	31047	Mostly Covered	31525	Mostly Covered	32085	Full Covered	32235	Full Covered
30327	Full Covered	30567	Mostly Covered	31054	Mostly Covered	31527	Mostly Covered	32086	Full Covered	32236	Full Covered
30328	Full Covered	30575	Mostly Covered	31059	Full Covered	31547	Full Covered	32091	Mostly Covered	32237	Full Covered
30329	Full Covered	30601	Full Covered	31061	Full Covered	31548	Mostly Covered	32097	Full Covered	32238	Full Covered
30330	Full Covered	30602	Full Covered	31062	Full Covered	31558	Full Covered	32099	Full Covered	32239	Full Covered
30331	Full Covered	30603	Full Covered	31069	Mostly Covered	31561	Mostly Covered	32110	Full Covered	32240	Full Covered
30332	Full Covered	30604	Full Covered	31075	Mostly Covered	31564	Mostly Covered	32111	Full Covered	32241	Full Covered
30333	Full Covered	30605	Full Covered	31086	Full Covered	31565	Mostly Covered	32114	Full Covered	32244	Full Covered
30334	Full Covered	30606	Full Covered	31088	Full Covered	31569	Mostly Covered	32115	Full Covered	32245	Full Covered
30336	Full Covered	30607	Full Covered	31093	Full Covered	31601	Full Covered	32116	Full Covered	32246	Full Covered
30337	Full Covered	30608	Full Covered	31095	Full Covered	31602	Full Covered	32117	Full Covered	32247	Full Covered
30338	Full Covered	30609	Full Covered	31098	Full Covered	31603	Full Covered	32118	Full Covered	32250	Full Covered
30339	Full Covered	30612	Full Covered	31099	Full Covered	31604	Full Covered	32119	Full Covered	32254	Full Covered
30340	Full Covered	30619	Mostly Covered	31106	Full Covered	31605	Mostly Covered	32120	Full Covered	32255	Full Covered
30341	Full Covered	30620	Mostly Covered	31107	Full Covered	31606	Mostly Covered	32121	Full Covered	32256	Full Covered
30342	Full Covered	30621	Mostly Covered	31119	Full Covered	31632	Mostly Covered	32122	Full Covered	32257	Full Covered
30343	Full Covered	30622	Full Covered	31126	Full Covered	31698	Full Covered	32123	Full Covered	32258	Full Covered
30344	Full Covered	30625	Mostly Covered	31131	Full Covered	31701	Full Covered	32124	Full Covered	32259	Full Covered
30345	Full Covered	30631	Full Covered	31132	Full Covered	31702	Full Covered	32125	Full Covered	32260	Full Covered
30346	Full Covered	30641	Mostly Covered	31139	Full Covered	31703	Full Covered	32126	Full Covered	32266	Full Covered
30347	Full Covered	30642	Full Covered	31141	Full Covered	31704	Mostly Covered	32127	Mostly Covered	32267	Full Covered
30348	Full Covered	30645	Mostly Covered	31145	Full Covered	31706	Full Covered	32128	Mostly Covered	32276	Full Covered
30349	Full Covered	30646	Mostly Covered	31146	Full Covered	31707	Full Covered	32129	Full Covered	32277	Full Covered
30350	Full Covered	30655	Full Covered	31150	Full Covered	31708	Full Covered	32130	Mostly Covered	32290	Full Covered
30353	Full Covered	30656	Mostly Covered	31156	Full Covered	31721	Mostly Covered	32131	Full Covered	32301	Full Covered
30354	Full Covered	30663	Mostly Covered	31191	Full Covered	31727	Mostly Covered	32132	Full Covered	32302	Full Covered
30355	Full Covered	30664	Full Covered	31192	Full Covered	31733	Mostly Covered	32135	Mostly Covered	32303	Full Covered
30356	Full Covered	30665	Full Covered	31193	Full Covered	31757	Full Covered	32136	Full Covered	32304	Full Covered
30357	Full Covered	30666	Mostly Covered	31195	Full Covered	31758	Full Covered	32137	Mostly Covered	32305	Mostly Covered
30358	Full Covered	30669	Mostly Covered	31196	Full Covered	31763	Mostly Covered	32141	Full Covered	32306	Full Covered
30359	Full Covered	30677	Mostly Covered	31197	Full Covered	31773	Mostly Covered	32142	Mostly Covered	32307	Full Covered
30360	Full Covered	30678	Mostly Covered	31198	Full Covered	31775	Mostly Covered	32145	Mostly Covered	32308	Full Covered
30361	Full Covered	30680	Full Covered	31199	Full Covered	31782	Mostly Covered	32151	Full Covered	32311	Mostly Covered
30362	Full Covered	30683	Full Covered	31201	Full Covered	31789	Mostly Covered	32158	Full Covered	32312	Mostly Covered
30363	Full Covered	30710	Mostly Covered	31202	Full Covered	31792	Full Covered	32159	Full Covered	32313	Full Covered
30364	Full Covered	30719	Full Covered	31203	Full Covered	31793	Full Covered	32162	Mostly Covered	32314	Full Covered
30366	Full Covered	30720	Full Covered	31204	Full Covered	31794	Full Covered	32164	Full Covered	32315	Full Covered
30368	Full Covered	30721	Mostly Covered	31205	Full Covered	31795	Full Covered	32168	Full Covered	32316	Full Covered
30369	Full Covered	30722	Full Covered	31206	Full Covered	31799	Full Covered	32169	Full Covered	32318	Full Covered
30370	Full Covered	30725	Full Covered	31207	Full Covered	31820	Mostly Covered	32170	Full Covered	32330	Mostly Covered
30371	Full Covered	30726	Full Covered	31208	Full Covered	31821	Mostly Covered	32173	Full Covered	32332	Full Covered
30374	Full Covered	30735	Mostly Covered	31209	Full Covered	31833	Full Covered	32174	Mostly Covered	32333	Mostly Covered
30375	Full Covered	30736	Full Covered	31210	Full Covered	31901	Full Covered	32175	Full Covered	32343	Mostly Covered
30376	Full Covered	30740	Full Covered	31211	Full Covered	31902	Full Covered	32176	Mostly Covered	32351	Full Covered
30377	Full Covered	30741	Full Covered	31212	Full Covered	31903	Full Covered	32177	Full Covered	32352	Full Covered
30378	Full Covered	30742	Full Covered	31213	Full Covered	31904	Full Covered	32178	Full Covered	32353	Full Covered
30379	Full Covered	30746	Mostly Covered	31216	Full Covered	31905	Full Covered	32183	Mostly Covered	32362	Mostly Covered
30380	Full Covered	30750	Full Covered	31217	Mostly Covered	31906	Full Covered	32187	Mostly Covered	32395	Full Covered
30384	Full Covered	30752	Full Covered	31220	Mostly Covered	31907	Full Covered	32189	Mostly Covered	32399	Full Covered
30385	Full Covered	30755	Full Covered	31221	Full Covered	31908	Full Covered	32192	Mostly Covered	32401	Full Covered
30386	Full Covered	30756	Mostly Covered	31295	Full Covered	31909	Full Covered	32195	Mostly Covered	32402	Full Covered
30387	Full Covered	30757	Full Covered	31296	Full Covered	31914	Full Covered	32198	Full Covered	32404	Mostly Covered
30388	Full Covered	30805	Mostly Covered	31297	Full Covered	31917	Full Covered	32201	Full Covered	32405	Full Covered
30389	Full Covered	30809	Mostly Covered	31322	Mostly Covered	31995	Full Covered	32202	Full Covered	32406	Full Covered
30390	Full Covered	30812	Full Covered	31328	Mostly Covered	31997	Full Covered	32203	Full Covered	32407	Mostly Covered
30392	Full Covered	30813	Mostly Covered	31401	Full Covered	31999	Full Covered	32204	Full Covered	32408	Mostly Covered
30394	Full Covered	30815	Mostly Covered	31402	Full Covered	32003	Full Covered	32205	Full Covered	32410	Full Covered
30396	Full Covered	30821	Mostly Covered	31403	Full Covered	32004	Full Covered	32206	Full Covered	32411	Full Covered
30398	Full Covered	30901	Full Covered	31404	Full Covered	32006	Full Covered	32207	Full Covered	32412	Full Covered
30399	Full Covered	30903	Full Covered	31405	Full Covered	32007	Full Covered	32208	Full Covered	32417	Mostly Covered
30424	Mostly Covered	30904	Full Covered	31406	Full Covered	32009	Mostly Covered	32209	Full Covered	32444	Full Covered
30451	Mostly Covered	30905	Mostly Covered	31407	Mostly Covered	32024	Mostly Covered	32210	Full Covered	32501	Full Covered
30452	Mostly Covered	30906	Mostly Covered	31408	Full Covered	32025	Full Covered	32211	Full Covered	32502	Full Covered
30458	Full Covered	30907	Full Covered	31409	Full Covered	32030	Full Covered	32212	Full Covered	32503	Full Covered
30459	Full Covered	30909	Full Covered	31410	Mostly Covered	32033	Mostly Covered	32214	Full Covered	32504	Full Covered

Zip Code	Coverage Level	Zip Code	Coverage Level	Zip Code	Coverage Level	Zip Code	Coverage Level	Zip Code	Coverage Level	Zip Code	Coverage Level
34789	Mostly Covered	35161	Full Covered	35401	Full Covered	35811	Full Covered	36254	Mostly Covered	36622	Full Covered
34797	Full Covered	35172	Mostly Covered	35402	Full Covered	35812	Full Covered	36257	Full Covered	36625	Full Covered
34945	Mostly Covered	35173	Mostly Covered	35403	Full Covered	35813	Full Covered	36258	Full Covered	36628	Full Covered
34946	Full Covered	35176	Full Covered	35404	Full Covered	35814	Full Covered	36260	Mostly Covered	36633	Full Covered
34947	Full Covered	35178	Mostly Covered	35405	Full Covered	35815	Full Covered	36262	Mostly Covered	36640	Full Covered
34948	Full Covered	35179	Mostly Covered	35407	Full Covered	35816	Full Covered	36265	Full Covered	36652	Full Covered
34949	Full Covered	35180	Full Covered	35449	Full Covered	35824	Full Covered	36266	Mostly Covered	36660	Full Covered
34950	Full Covered	35181	Mostly Covered	35453	Full Covered	35893	Full Covered	36268	Full Covered	36663	Full Covered
34951	Full Covered	35182	Full Covered	35456	Full Covered	35894	Full Covered	36272	Full Covered	36670	Full Covered
34952	Mostly Covered	35185	Mostly Covered	35473	Mostly Covered	35896	Full Covered	36277	Full Covered	36671	Full Covered
34954	Full Covered	35187	Mostly Covered	35476	Mostly Covered	35897	Full Covered	36279	Mostly Covered	36675	Full Covered
34957	Mostly Covered	35201	Full Covered	35485	Full Covered	35898	Full Covered	36301	Full Covered	36685	Full Covered
34958	Mostly Covered	35202	Full Covered	35486	Full Covered	35899	Full Covered	36302	Full Covered	36688	Full Covered
34979	Full Covered	35203	Full Covered	35487	Full Covered	35901	Full Covered	36303	Full Covered	36689	Full Covered
34981	Full Covered	35204	Full Covered	35501	Full Covered	35902	Full Covered	36304	Full Covered	36691	Full Covered
34982	Full Covered	35205	Full Covered	35502	Full Covered	35903	Mostly Covered	36305	Mostly Covered	36693	Full Covered
34983	Mostly Covered	35206	Full Covered	35503	Mostly Covered	35904	Full Covered	36312	Mostly Covered	36695	Mostly Covered
34984	Mostly Covered	35207	Full Covered	35504	Mostly Covered	35905	Mostly Covered	36313	Mostly Covered	36701	Full Covered
34985	Mostly Covered	35208	Full Covered	35542	Full Covered	35906	Full Covered	36316	Mostly Covered	36702	Full Covered
34986	Full Covered	35209	Full Covered	35545	Mostly Covered	35907	Mostly Covered	36320	Mostly Covered	36703	Mostly Covered
34990	Full Covered	35210	Full Covered	35550	Mostly Covered	35950	Full Covered	36321	Full Covered	36775	Mostly Covered
34991	Full Covered	35211	Full Covered	35555	Full Covered	35951	Full Covered	36322	Full Covered	36801	Full Covered
34992	Full Covered	35212	Full Covered	35560	Mostly Covered	35954	Full Covered	36330	Full Covered	36802	Full Covered
34994	Full Covered	35213	Full Covered	35579	Mostly Covered	35957	Mostly Covered	36331	Full Covered	36803	Full Covered
34995	Full Covered	35214	Full Covered	35580	Full Covered	35958	Full Covered	36345	Mostly Covered	36804	Full Covered
34996	Full Covered	35215	Full Covered	35581	Mostly Covered	35966	Mostly Covered	36349	Mostly Covered	36830	Full Covered
34997	Full Covered	35216	Full Covered	35585	Full Covered	35976	Full Covered	36351	Mostly Covered	36831	Full Covered
35004	Full Covered	35217	Full Covered	35587	Mostly Covered	35979	Mostly Covered	36362	Mostly Covered	36832	Full Covered
35005	Mostly Covered	35218	Full Covered	35601	Full Covered	35980	Mostly Covered	36376	Full Covered	36849	Full Covered
35007	Full Covered	35219	Full Covered	35602	Full Covered	36008	Full Covered	36420	Full Covered	36851	Full Covered
35010	Full Covered	35220	Full Covered	35603	Full Covered	36020	Full Covered	36474	Mostly Covered	36852	Mostly Covered
35011	Full Covered	35221	Full Covered	35609	Full Covered	36022	Mostly Covered	36476	Full Covered	36853	Mostly Covered
35014	Full Covered	35222	Full Covered	35610	Mostly Covered	36025	Full Covered	36507	Full Covered	36854	Mostly Covered
35015	Full Covered	35223	Full Covered	35615	Mostly Covered	36038	Mostly Covered	36509	Mostly Covered	36856	Full Covered
35020	Full Covered	35224	Full Covered	35622	Full Covered	36054	Full Covered	36511	Full Covered	36859	Full Covered
35021	Full Covered	35225	Full Covered	35631	Mostly Covered	36057	Mostly Covered	36523	Mostly Covered	36861	Full Covered
35022	Mostly Covered	35226	Full Covered	35632	Mostly Covered	36064	Mostly Covered	36526	Full Covered	36863	Full Covered
35023	Full Covered	35228	Full Covered	35640	Full Covered	36066	Full Covered	36527	Full Covered	36865	Full Covered
35036	Mostly Covered	35229	Full Covered	35645	Full Covered	36067	Mostly Covered	36530	Mostly Covered	36867	Full Covered
35040	Mostly Covered	35230	Full Covered	35648	Full Covered	36068	Full Covered	36532	Full Covered	36868	Full Covered
35041	Mostly Covered	35231	Full Covered	35649	Full Covered	36093	Mostly Covered	36533	Mostly Covered	36869	Full Covered
35043	Full Covered	35232	Full Covered	35652	Full Covered	36101	Full Covered	36535	Full Covered	36870	Full Covered
35048	Mostly Covered	35233	Full Covered	35653	Mostly Covered	36102	Full Covered	36536	Mostly Covered	36871	Full Covered
35052	Full Covered	35234	Full Covered	35654	Mostly Covered	36103	Full Covered	36541	Mostly Covered	36872	Full Covered
35054	Full Covered	35235	Full Covered	35660	Full Covered	36104	Full Covered	36542	Mostly Covered	36874	Mostly Covered
35055	Full Covered	35236	Full Covered	35662	Mostly Covered	36105	Full Covered	36544	Full Covered	36875	Mostly Covered
35056	Full Covered	35237	Full Covered	35671	Full Covered	36106	Full Covered	36547	Full Covered	36877	Full Covered
35057	Full Covered	35238	Full Covered	35673	Mostly Covered	36107	Full Covered	36551	Full Covered	36879	Mostly Covered
35058	Mostly Covered	35240	Full Covered	35674	Full Covered	36108	Mostly Covered	36555	Full Covered	37011	Full Covered
35060	Mostly Covered	35242	Full Covered	35699	Full Covered	36109	Full Covered	36559	Full Covered	37013	Full Covered
35061	Full Covered	35243	Full Covered	35740	Mostly Covered	36110	Full Covered	36561	Full Covered	37014	Full Covered
35063	Mostly Covered	35244	Full Covered	35741	Full Covered	36111	Full Covered	36562	Mostly Covered	37020	Mostly Covered
35064	Full Covered	35245	Full Covered	35742	Full Covered	36112	Full Covered	36564	Mostly Covered	37022	Mostly Covered
35068	Full Covered	35246	Full Covered	35747	Mostly Covered	36113	Full Covered	36567	Mostly Covered	37024	Full Covered
35071	Full Covered	35249	Full Covered	35748	Mostly Covered	36114	Full Covered	36568	Full Covered	37025	Full Covered
35077	Mostly Covered	35253	Full Covered	35749	Full Covered	36115	Full Covered	36571	Mostly Covered	37027	Full Covered
35079	Mostly Covered	35254	Full Covered	35750	Mostly Covered	36116	Full Covered	36572	Mostly Covered	37029	Full Covered
35080	Full Covered	35255	Full Covered	35752	Mostly Covered	36117	Full Covered	36575	Mostly Covered	37032	Mostly Covered
35089	Mostly Covered	35259	Full Covered	35754	Mostly Covered	36118	Full Covered	36576	Mostly Covered	37037	Full Covered
35091	Full Covered	35260	Full Covered	35755	Mostly Covered	36119	Full Covered	36577	Full Covered	37040	Full Covered
35094	Full Covered	35261	Full Covered	35756	Full Covered	36120	Full Covered	36578	Full Covered	37041	Full Covered
35096	Mostly Covered	35266	Full Covered	35757	Full Covered	36121	Full Covered	36579	Mostly Covered	37042	Full Covered
35098	Mostly Covered	35277	Full Covered	35758	Full Covered	36123	Full Covered	36580	Mostly Covered	37043	Mostly Covered
35112	Mostly Covered	35278	Full Covered	35759	Full Covered	36124	Full Covered	36582	Full Covered	37044	Full Covered
35114	Mostly Covered	35279	Full Covered	35760	Mostly Covered	36125	Full Covered	36590	Full Covered	37046	Mostly Covered
35115	Full Covered	35280	Full Covered	35762	Full Covered	36130	Full Covered	36601	Full Covered	37048	Full Covered
35116	Full Covered	35281	Full Covered	35763	Full Covered	36131	Full Covered	36602	Full Covered	37049	Mostly Covered
35117	Mostly Covered	35282	Full Covered	35767	Full Covered	36132	Full Covered	36603	Full Covered	37055	Full Covered
35118	Full Covered	35283	Full Covered	35768	Full Covered	36133	Full Covered	36604	Full Covered	37056	Full Covered
35119	Full Covered	35285	Full Covered	35769	Full Covered	36135	Full Covered	36605	Full Covered	37057	Full Covered
35120	Mostly Covered	35286	Full Covered	35771	Mostly Covered	36140	Full Covered	36606	Full Covered	37059	Mostly Covered
35124	Full Covered	35287	Full Covered	35773	Mostly Covered	36141	Full Covered	36607	Full Covered	37063	Full Covered
35125	Full Covered	35288	Full Covered	35775	Mostly Covered	36142	Full Covered	36608	Mostly Covered	37064	Mostly Covered
35127	Full Covered	35289	Full Covered	35776	Mostly Covered	36177	Full Covered	36609	Full Covered	37065	Full Covered
35128	Full Covered	35290	Full Covered	35801	Full Covered	36191	Full Covered	36610	Full Covered	37066	Full Covered
35131	Mostly Covered	35291	Full Covered	35802	Full Covered	36201	Full Covered	36611	Full Covered	37067	Full Covered
35135	Full Covered	35292	Full Covered	35803	Full Covered	36202	Full Covered	36612	Full Covered	37068	Full Covered
35137	Full Covered	35293	Full Covered	35804	Full Covered	36203	Full Covered	36613	Full Covered	37069	Full Covered
35139	Mostly Covered	35294	Full Covered	35805	Full Covered	36204	Full Covered	36615	Full Covered	37070	Full Covered
35142	Full Covered	35295	Full Covered	35806	Full Covered	36205	Mostly Covered	36616	Full Covered	37071	Full Covered
35144	Full Covered	35296	Full Covered	35807	Full Covered	36206	Mostly Covered	36617	Full Covered	37072	Full Covered
35147	Mostly Covered	35297	Full Covered	35808	Full Covered	36207	Mostly Covered	36618	Full Covered	37073	Full Covered
35149	Mostly Covered	35298	Full Covered	35809	Full Covered	36250	Mostly Covered	36619	Full Covered	37074	Mostly Covered
35160	Mostly Covered	35299	Full Covered	35810	Full Covered	36253	Full Covered	36621	Full Covered	37075	Full Covered

Zip Code	Coverage Level	Zip Code	Coverage Level	Zip Code	Coverage Level	Zip Code	Coverage Level	Zip Code	Coverage Level	Zip Code	Coverage Level
37076	Full Covered	37245	Full Covered	37701	Mostly Covered	37997	Mostly Covered	38175	Full Covered	38858	Mostly Covered
37077	Full Covered	37246	Full Covered	37705	Mostly Covered	37998	Mostly Covered	38177	Full Covered	38862	Full Covered
37080	Full Covered	37247	Full Covered	37708	Full Covered	38002	Mostly Covered	38181	Full Covered	38865	Mostly Covered
37083	Full Covered	37248	Full Covered	37710	Full Covered	38004	Mostly Covered	38182	Full Covered	38866	Mostly Covered
37086	Full Covered	37249	Full Covered	37714	Full Covered	38007	Full Covered	38183	Full Covered	38868	Mostly Covered
37087	Mostly Covered	37250	Full Covered	37716	Full Covered	38012	Full Covered	38184	Full Covered	38869	Mostly Covered
37088	Mostly Covered	37302	Full Covered	37717	Full Covered	38014	Full Covered	38186	Full Covered	38879	Full Covered
37089	Full Covered	37303	Full Covered	37719	Mostly Covered	38015	Mostly Covered	38187	Full Covered	38917	Mostly Covered
37090	Full Covered	37309	Mostly Covered	37722	Full Covered	38016	Full Covered	38188	Full Covered	38930	Full Covered
37095	Mostly Covered	37310	Full Covered	37725	Mostly Covered	38017	Full Covered	38190	Full Covered	38935	Full Covered
37098	Mostly Covered	37311	Full Covered	37737	Mostly Covered	38018	Full Covered	38193	Mostly Covered	38945	Full Covered
37115	Full Covered	37312	Full Covered	37738	Full Covered	38023	Full Covered	38194	Full Covered	38954	Full Covered
37116	Full Covered	37315	Full Covered	37742	Mostly Covered	38024	Full Covered	38195	Full Covered	39041	Mostly Covered
37119	Mostly Covered	37320	Full Covered	37743	Mostly Covered	38025	Full Covered	38197	Full Covered	39042	Mostly Covered
37121	Mostly Covered	37321	Full Covered	37748	Full Covered	38027	Full Covered	38301	Full Covered	39043	Full Covered
37122	Full Covered	37322	Mostly Covered	37754	Full Covered	38028	Full Covered	38302	Full Covered	39047	Full Covered
37127	Full Covered	37323	Mostly Covered	37757	Mostly Covered	38029	Full Covered	38303	Full Covered	39056	Full Covered
37128	Full Covered	37329	Mostly Covered	37760	Mostly Covered	38030	Mostly Covered	38305	Full Covered	39058	Full Covered
37129	Mostly Covered	37330	Mostly Covered	37763	Mostly Covered	38047	Full Covered	38308	Full Covered	39059	Full Covered
37130	Mostly Covered	37331	Mostly Covered	37764	Mostly Covered	38048	Full Covered	38313	Mostly Covered	39060	Full Covered
37131	Mostly Covered	37332	Full Covered	37769	Full Covered	38053	Mostly Covered	38314	Full Covered	39077	Full Covered
37132	Full Covered	37336	Mostly Covered	37771	Full Covered	38054	Mostly Covered	38324	Mostly Covered	39083	Full Covered
37133	Full Covered	37340	Mostly Covered	37772	Full Covered	38055	Mostly Covered	38328	Mostly Covered	39110	Full Covered
37135	Full Covered	37341	Full Covered	37774	Full Covered	38058	Mostly Covered	38339	Mostly Covered	39111	Full Covered
37136	Mostly Covered	37342	Mostly Covered	37777	Mostly Covered	38060	Mostly Covered	38351	Full Covered	39112	Full Covered
37138	Full Covered	37343	Full Covered	37778	Full Covered	38066	Full Covered	38355	Mostly Covered	39114	Full Covered
37143	Mostly Covered	37347	Full Covered	37801	Mostly Covered	38069	Full Covered	38357	Mostly Covered	39119	Mostly Covered
37145	Mostly Covered	37349	Full Covered	37802	Mostly Covered	38070	Mostly Covered	38362	Full Covered	39120	Full Covered
37146	Mostly Covered	37350	Full Covered	37803	Full Covered	38071	Mostly Covered	38366	Mostly Covered	39121	Full Covered
37148	Full Covered	37351	Full Covered	37804	Mostly Covered	38083	Mostly Covered	38367	Mostly Covered	39122	Full Covered
37150	Mostly Covered	37353	Full Covered	37813	Full Covered	38088	Full Covered	38378	Mostly Covered	39130	Full Covered
37152	Full Covered	37355	Full Covered	37814	Full Covered	38101	Full Covered	38387	Mostly Covered	39154	Mostly Covered
37153	Mostly Covered	37360	Mostly Covered	37815	Full Covered	38103	Full Covered	38388	Full Covered	39157	Full Covered
37155	Full Covered	37363	Full Covered	37816	Full Covered	38104	Full Covered	38390	Mostly Covered	39158	Full Covered
37160	Full Covered	37364	Full Covered	37821	Mostly Covered	38105	Full Covered	38393	Mostly Covered	39161	Mostly Covered
37161	Full Covered	37370	Mostly Covered	37822	Mostly Covered	38106	Full Covered	38401	Full Covered	39165	Mostly Covered
37162	Full Covered	37371	Full Covered	37826	Full Covered	38107	Full Covered	38402	Full Covered	39170	Mostly Covered
37167	Full Covered	37377	Full Covered	37828	Mostly Covered	38108	Full Covered	38451	Mostly Covered	39174	Full Covered
37172	Full Covered	37379	Mostly Covered	37829	Mostly Covered	38109	Full Covered	38501	Mostly Covered	39180	Full Covered
37174	Full Covered	37380	Mostly Covered	37830	Full Covered	38111	Full Covered	38502	Full Covered	39181	Full Covered
37179	Full Covered	37381	Mostly Covered	37831	Full Covered	38112	Full Covered	38503	Full Covered	39182	Full Covered
37183	Full Covered	37382	Full Covered	37840	Full Covered	38113	Full Covered	38505	Full Covered	39183	Mostly Covered
37187	Mostly Covered	37384	Full Covered	37845	Mostly Covered	38114	Full Covered	38506	Full Covered	39190	Full Covered
37188	Full Covered	37389	Full Covered	37849	Full Covered	38115	Full Covered	38555	Full Covered	39191	Full Covered
37189	Full Covered	37396	Full Covered	37854	Mostly Covered	38116	Full Covered	38557	Full Covered	39193	Mostly Covered
37190	Full Covered	37401	Mostly Covered	37860	Mostly Covered	38117	Full Covered	38558	Mostly Covered	39201	Full Covered
37201	Full Covered	37402	Full Covered	37862	Full Covered	38118	Full Covered	38571	Mostly Covered	39202	Full Covered
37202	Full Covered	37403	Full Covered	37863	Full Covered	38119	Full Covered	38572	Mostly Covered	39203	Full Covered
37203	Full Covered	37404	Full Covered	37864	Full Covered	38120	Full Covered	38583	Mostly Covered	39204	Full Covered
37204	Full Covered	37405	Mostly Covered	37865	Full Covered	38122	Full Covered	38601	Mostly Covered	39205	Full Covered
37205	Full Covered	37406	Mostly Covered	37868	Full Covered	38124	Full Covered	38602	Full Covered	39206	Full Covered
37206	Full Covered	37407	Full Covered	37876	Mostly Covered	38125	Full Covered	38632	Mostly Covered	39207	Full Covered
37207	Full Covered	37408	Full Covered	37877	Full Covered	38126	Full Covered	38637	Full Covered	39208	Full Covered
37208	Full Covered	37409	Full Covered	37878	Full Covered	38127	Full Covered	38651	Full Covered	39209	Full Covered
37209	Full Covered	37410	Full Covered	37881	Mostly Covered	38128	Full Covered	38654	Mostly Covered	39210	Full Covered
37210	Full Covered	37411	Full Covered	37882	Mostly Covered	38129	Full Covered	38655	Full Covered	39211	Full Covered
37211	Full Covered	37412	Full Covered	37886	Mostly Covered	38130	Full Covered	38665	Mostly Covered	39212	Full Covered
37212	Full Covered	37414	Full Covered	37890	Mostly Covered	38131	Full Covered	38671	Full Covered	39213	Full Covered
37213	Full Covered	37415	Full Covered	37901	Mostly Covered	38132	Full Covered	38672	Full Covered	39215	Full Covered
37214	Full Covered	37416	Mostly Covered	37902	Mostly Covered	38133	Full Covered	38673	Full Covered	39216	Full Covered
37215	Full Covered	37419	Full Covered	37909	Full Covered	38134	Full Covered	38675	Full Covered	39217	Full Covered
37216	Full Covered	37421	Full Covered	37912	Full Covered	38135	Full Covered	38677	Full Covered	39218	Full Covered
37217	Full Covered	37422	Mostly Covered	37915	Mostly Covered	38136	Full Covered	38680	Full Covered	39225	Full Covered
37218	Full Covered	37424	Mostly Covered	37916	Mostly Covered	38137	Full Covered	38686	Mostly Covered	39232	Full Covered
37219	Full Covered	37450	Full Covered	37917	Mostly Covered	38138	Full Covered	38701	Full Covered	39235	Full Covered
37220	Full Covered	37501	Full Covered	37918	Full Covered	38139	Full Covered	38702	Full Covered	39236	Full Covered
37221	Full Covered	37618	Full Covered	37919	Mostly Covered	38141	Mostly Covered	38703	Full Covered	39269	Full Covered
37222	Full Covered	37620	Mostly Covered	37921	Full Covered	38142	Full Covered	38704	Full Covered	39271	Full Covered
37224	Full Covered	37621	Mostly Covered	37922	Full Covered	38145	Full Covered	38723	Mostly Covered	39272	Full Covered
37227	Full Covered	37625	Mostly Covered	37923	Full Covered	38146	Full Covered	38760	Full Covered	39282	Full Covered
37228	Full Covered	37640	Mostly Covered	37927	Mostly Covered	38147	Full Covered	38776	Mostly Covered	39283	Full Covered
37229	Full Covered	37642	Mostly Covered	37928	Full Covered	38148	Full Covered	38780	Full Covered	39284	Full Covered
37230	Full Covered	37643	Full Covered	37929	Mostly Covered	38151	Full Covered	38782	Full Covered	39286	Full Covered
37232	Full Covered	37644	Mostly Covered	37930	Full Covered	38152	Full Covered	38801	Full Covered	39288	Full Covered
37234	Full Covered	37645	Full Covered	37931	Full Covered	38157	Full Covered	38802	Full Covered	39289	Full Covered
37235	Full Covered	37656	Mostly Covered	37932	Full Covered	38159	Full Covered	38803	Full Covered	39296	Full Covered
37236	Full Covered	37657	Mostly Covered	37933	Full Covered	38161	Full Covered	38804	Full Covered	39298	Full Covered
37238	Full Covered	37660	Full Covered	37938	Full Covered	38163	Full Covered	38821	Mostly Covered	39301	Full Covered
37239	Full Covered	37662	Mostly Covered	37939	Mostly Covered	38165	Full Covered	38825	Full Covered	39302	Full Covered
37240	Full Covered	37663	Mostly Covered	37940	Mostly Covered	38166	Full Covered	38826	Mostly Covered	39303	Full Covered
37241	Full Covered	37664	Full Covered	37950	Full Covered	38167	Full Covered	38834	Full Covered	39304	Full Covered
37242	Full Covered	37665	Full Covered	37990	Full Covered	38168	Full Covered	38835	Full Covered	39305	Mostly Covered
37243	Full Covered	37694	Mostly Covered	37995	Full Covered	38173	Full Covered	38846	Mostly Covered	39307	Mostly Covered
37244	Full Covered	37699	Mostly Covered	37996	Mostly Covered	38174	Full Covered	38857	Mostly Covered	39342	Mostly Covered

Zip Code	Coverage Level	Zip Code	Coverage Level	Zip Code	Coverage Level	Zip Code	Coverage Level	Zip Code	Coverage Level	Zip Code	Coverage Level
39401	Mostly Covered	40048	Full Covered	40261	Mostly Covered	40591	Full Covered	42086	Mostly Covered	42713	Full Covered
39402	Full Covered	40049	Mostly Covered	40266	Full Covered	40598	Full Covered	42101	Full Covered	42715	Mostly Covered
39403	Full Covered	40055	Full Covered	40268	Full Covered	40601	Full Covered	42102	Full Covered	42716	Mostly Covered
39404	Full Covered	40056	Mostly Covered	40269	Full Covered	40602	Full Covered	42104	Mostly Covered	42717	Full Covered
39406	Full Covered	40060	Mostly Covered	40270	Full Covered	40603	Full Covered	42120	Mostly Covered	42718	Full Covered
39437	Mostly Covered	40062	Mostly Covered	40272	Full Covered	40604	Full Covered	42123	Mostly Covered	42719	Full Covered
39440	Full Covered	40063	Full Covered	40280	Full Covered	40618	Full Covered	42124	Mostly Covered	42720	Full Covered
39441	Full Covered	40065	Full Covered	40281	Full Covered	40619	Full Covered	42127	Full Covered	42724	Mostly Covered
39442	Full Covered	40066	Full Covered	40282	Full Covered	40620	Full Covered	42128	Mostly Covered	42726	Mostly Covered
39443	Full Covered	40067	Mostly Covered	40283	Full Covered	40621	Full Covered	42129	Full Covered	42728	Full Covered
39460	Mostly Covered	40068	Mostly Covered	40285	Full Covered	40622	Full Covered	42130	Full Covered	42729	Mostly Covered
39475	Mostly Covered	40071	Mostly Covered	40289	Full Covered	40701	Full Covered	42131	Mostly Covered	42731	Full Covered
39477	Mostly Covered	40076	Full Covered	40290	Full Covered	40702	Full Covered	42134	Full Covered	42733	Mostly Covered
39482	Mostly Covered	40077	Full Covered	40291	Full Covered	40724	Mostly Covered	42135	Full Covered	42735	Full Covered
39501	Full Covered	40107	Mostly Covered	40292	Full Covered	40729	Mostly Covered	42141	Full Covered	42740	Mostly Covered
39502	Full Covered	40108	Full Covered	40296	Full Covered	40734	Mostly Covered	42142	Full Covered	42741	Mostly Covered
39503	Mostly Covered	40109	Full Covered	40297	Full Covered	40737	Full Covered	42150	Mostly Covered	42742	Mostly Covered
39505	Full Covered	40110	Mostly Covered	40298	Full Covered	40740	Full Covered	42152	Mostly Covered	42748	Full Covered
39506	Full Covered	40115	Full Covered	40299	Full Covered	40741	Full Covered	42153	Mostly Covered	42749	Mostly Covered
39507	Full Covered	40117	Full Covered	40310	Mostly Covered	40742	Full Covered	42154	Mostly Covered	42754	Full Covered
39530	Full Covered	40118	Full Covered	40312	Mostly Covered	40743	Full Covered	42156	Mostly Covered	42755	Full Covered
39531	Mostly Covered	40121	Full Covered	40320	Mostly Covered	40744	Full Covered	42160	Full Covered	42757	Mostly Covered
39532	Mostly Covered	40129	Full Covered	40324	Full Covered	40745	Full Covered	42163	Mostly Covered	42758	Full Covered
39533	Full Covered	40140	Full Covered	40330	Mostly Covered	40751	Mostly Covered	42164	Full Covered	42759	Full Covered
39534	Full Covered	40142	Full Covered	40336	Full Covered	40755	Full Covered	42166	Mostly Covered	42762	Full Covered
39535	Full Covered	40143	Mostly Covered	40339	Full Covered	40759	Mostly Covered	42170	Full Covered	42764	Mostly Covered
39540	Full Covered	40144	Full Covered	40340	Full Covered	40771	Full Covered	42201	Mostly Covered	42765	Full Covered
39552	Full Covered	40145	Mostly Covered	40342	Full Covered	40946	Mostly Covered	42202	Mostly Covered	42784	Mostly Covered
39553	Full Covered	40146	Full Covered	40356	Full Covered	41001	Mostly Covered	42206	Mostly Covered	42786	Full Covered
39560	Full Covered	40150	Mostly Covered	40357	Mostly Covered	41005	Full Covered	42207	Mostly Covered	43001	Full Covered
39563	Full Covered	40152	Mostly Covered	40372	Full Covered	41007	Mostly Covered	42209	Mostly Covered	43002	Full Covered
39564	Full Covered	40155	Mostly Covered	40383	Mostly Covered	41011	Full Covered	42217	Mostly Covered	43004	Full Covered
39565	Mostly Covered	40159	Full Covered	40384	Mostly Covered	41012	Full Covered	42219	Full Covered	43007	Full Covered
39566	Full Covered	40160	Full Covered	40386	Mostly Covered	41014	Full Covered	42240	Full Covered	43008	Mostly Covered
39567	Full Covered	40162	Mostly Covered	40390	Mostly Covered	41015	Full Covered	42241	Full Covered	43013	Mostly Covered
39568	Full Covered	40164	Mostly Covered	40391	Full Covered	41016	Full Covered	42251	Full Covered	43015	Mostly Covered
39569	Full Covered	40165	Full Covered	40392	Full Covered	41017	Full Covered	42252	Mostly Covered	43016	Full Covered
39581	Full Covered	40175	Mostly Covered	40410	Mostly Covered	41018	Full Covered	42261	Full Covered	43017	Full Covered
39595	Full Covered	40176	Mostly Covered	40422	Full Covered	41019	Full Covered	42262	Mostly Covered	43018	Full Covered
39601	Full Covered	40177	Full Covered	40423	Full Covered	41022	Full Covered	42265	Mostly Covered	43021	Full Covered
39602	Full Covered	40178	Mostly Covered	40440	Full Covered	41030	Mostly Covered	42266	Mostly Covered	43023	Mostly Covered
39603	Full Covered	40201	Full Covered	40452	Mostly Covered	41033	Mostly Covered	42270	Full Covered	43025	Mostly Covered
39701	Full Covered	40202	Full Covered	40464	Mostly Covered	41042	Full Covered	42274	Full Covered	43026	Full Covered
39702	Full Covered	40203	Full Covered	40467	Mostly Covered	41048	Full Covered	42276	Full Covered	43030	Full Covered
39703	Full Covered	40204	Full Covered	40472	Full Covered	41051	Full Covered	42283	Mostly Covered	43031	Full Covered
39704	Full Covered	40205	Full Covered	40475	Full Covered	41053	Full Covered	42286	Mostly Covered	43032	Full Covered
39705	Full Covered	40206	Full Covered	40476	Full Covered	41059	Full Covered	42288	Full Covered	43033	Mostly Covered
39710	Mostly Covered	40207	Full Covered	40484	Mostly Covered	41063	Full Covered	42301	Mostly Covered	43035	Full Covered
39730	Full Covered	40208	Full Covered	40495	Full Covered	41071	Full Covered	42302	Full Covered	43036	Full Covered
39736	Full Covered	40209	Full Covered	40502	Full Covered	41072	Full Covered	42303	Full Covered	43040	Full Covered
39753	Mostly Covered	40210	Full Covered	40503	Full Covered	41073	Full Covered	42304	Full Covered	43041	Full Covered
39756	Mostly Covered	40211	Full Covered	40504	Full Covered	41074	Full Covered	42334	Mostly Covered	43054	Full Covered
39759	Full Covered	40212	Full Covered	40505	Full Covered	41075	Full Covered	42355	Mostly Covered	43055	Full Covered
39760	Full Covered	40213	Full Covered	40507	Full Covered	41076	Full Covered	42366	Mostly Covered	43056	Full Covered
39762	Full Covered	40214	Full Covered	40508	Full Covered	41080	Full Covered	42376	Mostly Covered	43058	Full Covered
39766	Mostly Covered	40215	Full Covered	40509	Full Covered	41085	Full Covered	42402	Mostly Covered	43061	Mostly Covered
39815	Mostly Covered	40216	Full Covered	40510	Full Covered	41091	Full Covered	42410	Full Covered	43062	Full Covered
39817	Full Covered	40217	Full Covered	40511	Full Covered	41092	Mostly Covered	42413	Mostly Covered	43065	Full Covered
39818	Full Covered	40218	Full Covered	40512	Full Covered	41094	Full Covered	42419	Full Covered	43067	Mostly Covered
39819	Mostly Covered	40219	Full Covered	40513	Full Covered	41099	Full Covered	42420	Full Covered	43068	Full Covered
39825	Mostly Covered	40220	Mostly Covered	40514	Full Covered	41101	Mostly Covered	42431	Full Covered	43071	Mostly Covered
39834	Mostly Covered	40221	Full Covered	40515	Full Covered	41105	Mostly Covered	42436	Mostly Covered	43073	Full Covered
39852	Full Covered	40222	Mostly Covered	40516	Full Covered	41114	Mostly Covered	42440	Full Covered	43074	Full Covered
39901	Full Covered	40223	Mostly Covered	40517	Full Covered	41129	Mostly Covered	42441	Mostly Covered	43076	Mostly Covered
40003	Mostly Covered	40224	Full Covered	40522	Full Covered	41137	Full Covered	42442	Mostly Covered	43077	Mostly Covered
40004	Full Covered	40225	Full Covered	40523	Full Covered	41156	Mostly Covered	42451	Full Covered	43078	Mostly Covered
40006	Mostly Covered	40228	Mostly Covered	40524	Full Covered	41166	Full Covered	42457	Mostly Covered	43081	Full Covered
40010	Full Covered	40229	Mostly Covered	40526	Full Covered	41174	Full Covered	42458	Full Covered	43082	Full Covered
40013	Full Covered	40231	Full Covered	40533	Full Covered	41175	Full Covered	42501	Mostly Covered	43083	Mostly Covered
40014	Full Covered	40232	Full Covered	40536	Full Covered	41901	Full Covered	42502	Full Covered	43085	Full Covered
40018	Full Covered	40233	Full Covered	40544	Full Covered	41902	Full Covered	42503	Full Covered	43086	Full Covered
40020	Mostly Covered	40241	Mostly Covered	40546	Full Covered	41903	Full Covered	42519	Mostly Covered	43093	Full Covered
40022	Mostly Covered	40242	Mostly Covered	40555	Full Covered	41904	Full Covered	42528	Mostly Covered	43098	Mostly Covered
40023	Full Covered	40243	Full Covered	40574	Full Covered	41905	Full Covered	42533	Full Covered	43101	Mostly Covered
40025	Mostly Covered	40245	Mostly Covered	40575	Full Covered	41906	Full Covered	42553	Mostly Covered	43102	Mostly Covered
40026	Full Covered	40250	Mostly Covered	40576	Full Covered	42001	Full Covered	42558	Full Covered	43103	Mostly Covered
40027	Mostly Covered	40251	Full Covered	40577	Full Covered	42002	Full Covered	42564	Full Covered	43105	Mostly Covered
40031	Full Covered	40252	Mostly Covered	40578	Full Covered	42003	Full Covered	42567	Mostly Covered	43109	Full Covered
40032	Full Covered	40253	Mostly Covered	40579	Full Covered	42024	Mostly Covered	42629	Mostly Covered	43110	Full Covered
40033	Full Covered	40255	Full Covered	40580	Full Covered	42027	Full Covered	42642	Full Covered	43112	Full Covered
40037	Mostly Covered	40256	Full Covered	40581	Full Covered	42051	Mostly Covered	42701	Full Covered	43113	Full Covered
40041	Full Covered	40257	Full Covered	40582	Full Covered	42058	Mostly Covered	42702	Full Covered	43119	Full Covered
40046	Mostly Covered	40258	Full Covered	40583	Full Covered	42069	Mostly Covered	42711	Mostly Covered	43123	Full Covered
40047	Full Covered	40259	Mostly Covered	40588	Full Covered	42082	Mostly Covered	42712	Mostly Covered	43125	Full Covered

Zip Code	Coverage Level	Zip Code	Coverage Level	Zip Code	Coverage Level	Zip Code	Coverage Level	Zip Code	Coverage Level	Zip Code	Coverage Level
43126	Mostly Covered	43434	Full Covered	43952	Full Covered	44130	Full Covered	44303	Full Covered	44609	Full Covered
43130	Full Covered	43437	Mostly Covered	43953	Full Covered	44131	Full Covered	44304	Full Covered	44612	Full Covered
43136	Full Covered	43440	Mostly Covered	43961	Mostly Covered	44132	Full Covered	44305	Full Covered	44613	Full Covered
43137	Mostly Covered	43441	Full Covered	43963	Mostly Covered	44133	Full Covered	44306	Full Covered	44614	Mostly Covered
43140	Full Covered	43443	Full Covered	43964	Mostly Covered	44134	Full Covered	44307	Full Covered	44618	Full Covered
43147	Full Covered	43445	Mostly Covered	43971	Full Covered	44135	Full Covered	44308	Full Covered	44619	Full Covered
43148	Mostly Covered	43447	Full Covered	44001	Full Covered	44136	Full Covered	44309	Full Covered	44622	Full Covered
43149	Mostly Covered	43450	Full Covered	44004	Full Covered	44137	Full Covered	44310	Full Covered	44624	Mostly Covered
43151	Mostly Covered	43451	Full Covered	44005	Full Covered	44138	Full Covered	44311	Full Covered	44625	Mostly Covered
43154	Full Covered	43457	Mostly Covered	44010	Mostly Covered	44139	Full Covered	44312	Full Covered	44626	Full Covered
43155	Full Covered	43460	Full Covered	44011	Full Covered	44140	Full Covered	44313	Full Covered	44627	Mostly Covered
43156	Full Covered	43463	Full Covered	44012	Full Covered	44141	Full Covered	44314	Full Covered	44630	Full Covered
43157	Mostly Covered	43464	Mostly Covered	44017	Full Covered	44142	Full Covered	44315	Full Covered	44632	Full Covered
43162	Mostly Covered	43465	Full Covered	44021	Mostly Covered	44143	Full Covered	44316	Full Covered	44634	Mostly Covered
43163	Mostly Covered	43466	Full Covered	44022	Full Covered	44144	Full Covered	44317	Full Covered	44636	Full Covered
43195	Full Covered	43467	Mostly Covered	44023	Full Covered	44145	Full Covered	44319	Full Covered	44641	Mostly Covered
43196	Full Covered	43468	Full Covered	44024	Full Covered	44146	Full Covered	44320	Full Covered	44643	Mostly Covered
43198	Mostly Covered	43469	Mostly Covered	44026	Full Covered	44147	Full Covered	44321	Full Covered	44645	Mostly Covered
43199	Full Covered	43504	Mostly Covered	44028	Full Covered	44149	Full Covered	44322	Full Covered	44646	Full Covered
43201	Full Covered	43525	Mostly Covered	44030	Mostly Covered	44178	Full Covered	44325	Full Covered	44647	Full Covered
43202	Full Covered	43528	Full Covered	44033	Mostly Covered	44181	Full Covered	44326	Full Covered	44648	Full Covered
43203	Full Covered	43537	Full Covered	44035	Full Covered	44185	Full Covered	44328	Full Covered	44652	Mostly Covered
43204	Full Covered	43542	Full Covered	44036	Full Covered	44188	Full Covered	44333	Full Covered	44653	Mostly Covered
43205	Full Covered	43551	Mostly Covered	44039	Full Covered	44189	Full Covered	44334	Full Covered	44656	Mostly Covered
43206	Full Covered	43552	Mostly Covered	44040	Full Covered	44190	Full Covered	44372	Full Covered	44659	Full Covered
43207	Full Covered	43558	Mostly Covered	44044	Mostly Covered	44191	Full Covered	44393	Full Covered	44662	Full Covered
43209	Full Covered	43560	Full Covered	44045	Full Covered	44192	Full Covered	44396	Full Covered	44663	Mostly Covered
43210	Full Covered	43565	Mostly Covered	44047	Full Covered	44193	Full Covered	44398	Full Covered	44665	Full Covered
43211	Full Covered	43566	Mostly Covered	44048	Full Covered	44194	Full Covered	44399	Full Covered	44666	Full Covered
43212	Full Covered	43571	Mostly Covered	44049	Full Covered	44195	Full Covered	44401	Mostly Covered	44667	Full Covered
43213	Full Covered	43601	Full Covered	44050	Full Covered	44198	Full Covered	44402	Mostly Covered	44671	Full Covered
43214	Full Covered	43602	Full Covered	44052	Full Covered	44199	Full Covered	44405	Full Covered	44672	Full Covered
43215	Full Covered	43603	Full Covered	44053	Full Covered	44201	Mostly Covered	44406	Full Covered	44677	Full Covered
43216	Full Covered	43604	Full Covered	44054	Full Covered	44202	Mostly Covered	44408	Mostly Covered	44678	Full Covered
43217	Mostly Covered	43605	Full Covered	44055	Full Covered	44203	Full Covered	44410	Full Covered	44680	Full Covered
43218	Full Covered	43606	Full Covered	44056	Full Covered	44210	Full Covered	44413	Mostly Covered	44685	Full Covered
43219	Full Covered	43607	Full Covered	44060	Full Covered	44211	Full Covered	44416	Mostly Covered	44688	Mostly Covered
43220	Full Covered	43608	Full Covered	44061	Full Covered	44212	Full Covered	44418	Mostly Covered	44689	Mostly Covered
43221	Full Covered	43609	Full Covered	44065	Full Covered	44215	Full Covered	44420	Full Covered	44690	Mostly Covered
43222	Full Covered	43610	Full Covered	44067	Full Covered	44216	Full Covered	44422	Full Covered	44691	Full Covered
43223	Full Covered	43611	Full Covered	44068	Full Covered	44217	Mostly Covered	44423	Mostly Covered	44697	Full Covered
43224	Full Covered	43612	Full Covered	44070	Full Covered	44221	Full Covered	44425	Mostly Covered	44701	Full Covered
43226	Full Covered	43613	Full Covered	44072	Full Covered	44222	Full Covered	44430	Mostly Covered	44702	Full Covered
43227	Full Covered	43614	Full Covered	44073	Full Covered	44223	Full Covered	44431	Mostly Covered	44703	Full Covered
43228	Full Covered	43615	Full Covered	44074	Full Covered	44224	Full Covered	44436	Full Covered	44704	Full Covered
43229	Full Covered	43616	Full Covered	44077	Full Covered	44230	Mostly Covered	44437	Full Covered	44705	Full Covered
43230	Full Covered	43617	Full Covered	44081	Mostly Covered	44232	Full Covered	44440	Full Covered	44706	Full Covered
43231	Full Covered	43618	Full Covered	44087	Full Covered	44233	Full Covered	44442	Full Covered	44707	Full Covered
43232	Full Covered	43619	Full Covered	44089	Full Covered	44234	Mostly Covered	44443	Full Covered	44708	Full Covered
43234	Full Covered	43620	Full Covered	44090	Full Covered	44235	Full Covered	44445	Mostly Covered	44709	Full Covered
43235	Full Covered	43623	Full Covered	44092	Full Covered	44236	Full Covered	44446	Full Covered	44710	Full Covered
43236	Full Covered	43624	Full Covered	44094	Full Covered	44237	Full Covered	44449	Mostly Covered	44711	Full Covered
43240	Full Covered	43635	Full Covered	44095	Full Covered	44240	Full Covered	44451	Mostly Covered	44712	Full Covered
43251	Full Covered	43652	Full Covered	44096	Full Covered	44241	Mostly Covered	44452	Mostly Covered	44714	Full Covered
43260	Full Covered	43654	Full Covered	44097	Full Covered	44242	Full Covered	44454	Full Covered	44718	Full Covered
43265	Full Covered	43656	Full Covered	44101	Full Covered	44243	Full Covered	44460	Full Covered	44720	Full Covered
43268	Full Covered	43657	Full Covered	44102	Full Covered	44250	Full Covered	44471	Full Covered	44721	Mostly Covered
43270	Full Covered	43659	Full Covered	44103	Full Covered	44251	Full Covered	44473	Full Covered	44730	Full Covered
43271	Full Covered	43660	Full Covered	44104	Full Covered	44253	Mostly Covered	44481	Full Covered	44735	Full Covered
43272	Full Covered	43661	Full Covered	44105	Full Covered	44254	Mostly Covered	44482	Full Covered	44750	Full Covered
43279	Full Covered	43666	Full Covered	44106	Full Covered	44255	Mostly Covered	44483	Full Covered	44760	Full Covered
43287	Full Covered	43667	Full Covered	44107	Full Covered	44256	Full Covered	44484	Full Covered	44767	Full Covered
43291	Full Covered	43681	Full Covered	44108	Full Covered	44258	Full Covered	44485	Full Covered	44798	Full Covered
43299	Full Covered	43682	Full Covered	44109	Full Covered	44260	Full Covered	44486	Full Covered	44799	Full Covered
43301	Full Covered	43697	Full Covered	44110	Full Covered	44262	Full Covered	44490	Mostly Covered	44805	Mostly Covered
43302	Full Covered	43699	Full Covered	44111	Full Covered	44264	Full Covered	44493	Full Covered	44811	Mostly Covered
43306	Full Covered	43721	Mostly Covered	44112	Full Covered	44265	Full Covered	44501	Full Covered	44813	Mostly Covered
43314	Mostly Covered	43739	Mostly Covered	44113	Full Covered	44266	Full Covered	44502	Full Covered	44814	Full Covered
43322	Full Covered	43740	Mostly Covered	44114	Full Covered	44270	Mostly Covered	44503	Full Covered	44816	Full Covered
43323	Mostly Covered	43905	Full Covered	44115	Full Covered	44272	Full Covered	44504	Full Covered	44824	Full Covered
43332	Mostly Covered	43906	Full Covered	44116	Full Covered	44273	Full Covered	44505	Mostly Covered	44826	Full Covered
43337	Full Covered	43909	Full Covered	44117	Full Covered	44274	Mostly Covered	44506	Full Covered	44828	Mostly Covered
43341	Full Covered	43912	Full Covered	44118	Full Covered	44275	Mostly Covered	44507	Full Covered	44839	Mostly Covered
43342	Mostly Covered	43913	Full Covered	44119	Full Covered	44276	Mostly Covered	44509	Full Covered	44840	Mostly Covered
43344	Mostly Covered	43916	Full Covered	44120	Full Covered	44278	Full Covered	44510	Full Covered	44843	Mostly Covered
43356	Mostly Covered	43926	Full Covered	44121	Full Covered	44280	Full Covered	44511	Full Covered	44846	Mostly Covered
43402	Full Covered	43934	Full Covered	44122	Full Covered	44281	Mostly Covered	44512	Full Covered	44847	Mostly Covered
43403	Full Covered	43935	Full Covered	44123	Full Covered	44282	Mostly Covered	44513	Full Covered	44848	Full Covered
43406	Full Covered	43937	Full Covered	44124	Full Covered	44285	Full Covered	44514	Full Covered	44851	Mostly Covered
43408	Mostly Covered	43938	Full Covered	44125	Full Covered	44286	Full Covered	44515	Full Covered	44855	Mostly Covered
43410	Mostly Covered	43939	Mostly Covered	44126	Full Covered	44287	Full Covered	44555	Full Covered	44857	Full Covered
43412	Full Covered	43940	Full Covered	44127	Full Covered	44288	Mostly Covered	44599	Full Covered	44859	Mostly Covered
43414	Full Covered	43943	Mostly Covered	44128	Full Covered	44301	Full Covered	44606	Full Covered	44862	Full Covered
43430	Mostly Covered	43947	Mostly Covered	44129	Full Covered	44302	Full Covered	44608	Mostly Covered	44866	Full Covered

Zip Code	Coverage Level	Zip Code	Coverage Level	Zip Code	Coverage Level	Zip Code	Coverage Level	Zip Code	Coverage Level	Zip Code	Coverage Level
44870	Full Covered	45211	Full Covered	45343	Full Covered	45662	Full Covered	46129	Mostly Covered	46296	Full Covered
44871	Full Covered	45212	Full Covered	45344	Mostly Covered	45663	Full Covered	46130	Mostly Covered	46298	Full Covered
44874	Mostly Covered	45213	Full Covered	45345	Mostly Covered	45672	Mostly Covered	46131	Full Covered	46301	Mostly Covered
44880	Full Covered	45214	Full Covered	45347	Mostly Covered	45675	Full Covered	46133	Full Covered	46302	Mostly Covered
44889	Mostly Covered	45215	Full Covered	45349	Full Covered	45680	Full Covered	46142	Full Covered	46303	Full Covered
44901	Full Covered	45216	Full Covered	45356	Mostly Covered	45692	Full Covered	46143	Mostly Covered	46304	Full Covered
44902	Full Covered	45217	Full Covered	45359	Mostly Covered	45699	Mostly Covered	46144	Full Covered	46307	Full Covered
44903	Full Covered	45218	Full Covered	45370	Full Covered	45712	Mostly Covered	46146	Full Covered	46308	Full Covered
44904	Mostly Covered	45219	Full Covered	45371	Full Covered	45714	Full Covered	46150	Full Covered	46311	Full Covered
44905	Full Covered	45220	Full Covered	45372	Full Covered	45729	Mostly Covered	46151	Full Covered	46312	Full Covered
44906	Full Covered	45221	Full Covered	45373	Full Covered	45750	Full Covered	46157	Mostly Covered	46319	Mostly Covered
44907	Full Covered	45222	Full Covered	45374	Full Covered	45773	Mostly Covered	46158	Mostly Covered	46320	Full Covered
44999	Full Covered	45223	Full Covered	45377	Mostly Covered	45801	Mostly Covered	46160	Mostly Covered	46321	Full Covered
45001	Full Covered	45224	Full Covered	45381	Full Covered	45802	Full Covered	46161	Full Covered	46322	Full Covered
45002	Full Covered	45225	Full Covered	45382	Mostly Covered	45804	Full Covered	46162	Full Covered	46323	Full Covered
45004	Full Covered	45226	Full Covered	45383	Mostly Covered	45805	Full Covered	46163	Mostly Covered	46324	Full Covered
45005	Full Covered	45227	Full Covered	45384	Full Covered	45806	Full Covered	46164	Mostly Covered	46325	Full Covered
45011	Mostly Covered	45228	Full Covered	45385	Full Covered	45807	Full Covered	46166	Mostly Covered	46327	Full Covered
45012	Full Covered	45229	Full Covered	45387	Full Covered	45809	Full Covered	46167	Mostly Covered	46341	Mostly Covered
45013	Full Covered	45230	Full Covered	45389	Mostly Covered	45819	Mostly Covered	46168	Full Covered	46342	Full Covered
45014	Full Covered	45231	Full Covered	45401	Full Covered	45820	Mostly Covered	46173	Mostly Covered	46345	Mostly Covered
45015	Full Covered	45232	Full Covered	45402	Full Covered	45822	Full Covered	46176	Full Covered	46350	Full Covered
45018	Full Covered	45233	Full Covered	45403	Full Covered	45826	Mostly Covered	46181	Mostly Covered	46352	Full Covered
45025	Full Covered	45234	Full Covered	45404	Full Covered	45828	Full Covered	46182	Mostly Covered	46355	Mostly Covered
45026	Full Covered	45235	Full Covered	45405	Full Covered	45830	Mostly Covered	46183	Full Covered	46356	Full Covered
45030	Full Covered	45236	Full Covered	45406	Full Covered	45854	Full Covered	46184	Full Covered	46360	Full Covered
45032	Mostly Covered	45237	Full Covered	45407	Full Covered	45860	Mostly Covered	46201	Full Covered	46361	Mostly Covered
45033	Full Covered	45238	Full Covered	45408	Full Covered	45862	Mostly Covered	46202	Full Covered	46368	Full Covered
45034	Mostly Covered	45239	Full Covered	45409	Full Covered	45866	Full Covered	46203	Full Covered	46373	Mostly Covered
45036	Full Covered	45240	Full Covered	45410	Full Covered	45882	Mostly Covered	46204	Full Covered	46375	Mostly Covered
45039	Mostly Covered	45241	Full Covered	45412	Full Covered	45883	Mostly Covered	46205	Full Covered	46376	Mostly Covered
45040	Full Covered	45242	Full Covered	45413	Mostly Covered	45888	Mostly Covered	46206	Full Covered	46377	Mostly Covered
45041	Full Covered	45243	Full Covered	45414	Mostly Covered	45893	Mostly Covered	46207	Full Covered	46382	Mostly Covered
45042	Full Covered	45244	Full Covered	45415	Full Covered	45944	Full Covered	46208	Full Covered	46383	Full Covered
45043	Full Covered	45245	Full Covered	45416	Full Covered	45950	Full Covered	46209	Full Covered	46384	Full Covered
45044	Full Covered	45246	Full Covered	45417	Full Covered	45999	Full Covered	46211	Full Covered	46385	Full Covered
45050	Full Covered	45247	Full Covered	45418	Full Covered	46001	Mostly Covered	46214	Full Covered	46390	Mostly Covered
45051	Full Covered	45248	Full Covered	45419	Full Covered	46011	Full Covered	46216	Full Covered	46391	Full Covered
45052	Full Covered	45249	Full Covered	45420	Full Covered	46012	Full Covered	46217	Full Covered	46393	Full Covered
45053	Full Covered	45250	Full Covered	45422	Full Covered	46013	Full Covered	46218	Full Covered	46394	Full Covered
45054	Full Covered	45251	Full Covered	45423	Full Covered	46014	Full Covered	46219	Full Covered	46401	Mostly Covered
45055	Full Covered	45252	Full Covered	45424	Full Covered	46015	Full Covered	46220	Full Covered	46402	Mostly Covered
45056	Mostly Covered	45253	Full Covered	45426	Full Covered	46016	Full Covered	46221	Full Covered	46403	Full Covered
45061	Full Covered	45254	Full Covered	45427	Full Covered	46017	Full Covered	46222	Full Covered	46404	Mostly Covered
45062	Full Covered	45255	Full Covered	45428	Full Covered	46018	Full Covered	46224	Full Covered	46405	Full Covered
45063	Full Covered	45258	Full Covered	45429	Full Covered	46030	Mostly Covered	46225	Full Covered	46406	Full Covered
45064	Mostly Covered	45262	Full Covered	45430	Full Covered	46032	Full Covered	46226	Full Covered	46407	Mostly Covered
45065	Full Covered	45263	Full Covered	45431	Full Covered	46033	Full Covered	46227	Full Covered	46408	Mostly Covered
45066	Full Covered	45264	Full Covered	45432	Full Covered	46034	Mostly Covered	46228	Full Covered	46409	Full Covered
45067	Mostly Covered	45267	Full Covered	45433	Full Covered	46038	Full Covered	46229	Full Covered	46410	Mostly Covered
45068	Mostly Covered	45268	Full Covered	45434	Full Covered	46040	Mostly Covered	46230	Full Covered	46411	Mostly Covered
45069	Full Covered	45269	Full Covered	45435	Full Covered	46044	Mostly Covered	46231	Full Covered	46502	Full Covered
45071	Full Covered	45270	Full Covered	45437	Full Covered	46045	Mostly Covered	46234	Mostly Covered	46506	Mostly Covered
45073	Full Covered	45271	Full Covered	45439	Full Covered	46048	Mostly Covered	46235	Full Covered	46508	Full Covered
45099	Full Covered	45273	Full Covered	45440	Full Covered	46049	Mostly Covered	46236	Full Covered	46510	Full Covered
45102	Full Covered	45274	Full Covered	45441	Full Covered	46050	Mostly Covered	46237	Full Covered	46513	Mostly Covered
45103	Full Covered	45275	Full Covered	45448	Full Covered	46051	Mostly Covered	46239	Full Covered	46514	Full Covered
45106	Full Covered	45277	Full Covered	45449	Full Covered	46052	Full Covered	46240	Full Covered	46515	Full Covered
45111	Full Covered	45280	Full Covered	45454	Full Covered	46055	Mostly Covered	46241	Full Covered	46516	Full Covered
45113	Mostly Covered	45296	Full Covered	45458	Full Covered	46056	Mostly Covered	46242	Full Covered	46517	Full Covered
45122	Mostly Covered	45298	Full Covered	45459	Full Covered	46060	Full Covered	46244	Full Covered	46524	Mostly Covered
45130	Mostly Covered	45299	Full Covered	45463	Full Covered	46061	Full Covered	46247	Full Covered	46526	Mostly Covered
45140	Full Covered	45301	Full Covered	45469	Full Covered	46063	Mostly Covered	46249	Full Covered	46527	Mostly Covered
45145	Full Covered	45305	Full Covered	45470	Full Covered	46064	Mostly Covered	46250	Full Covered	46530	Mostly Covered
45147	Full Covered	45311	Mostly Covered	45475	Full Covered	46068	Full Covered	46251	Full Covered	46536	Full Covered
45150	Mostly Covered	45312	Full Covered	45479	Full Covered	46069	Full Covered	46253	Full Covered	46537	Full Covered
45152	Full Covered	45314	Mostly Covered	45481	Full Covered	46072	Mostly Covered	46254	Full Covered	46538	Full Covered
45154	Mostly Covered	45315	Mostly Covered	45482	Full Covered	46074	Full Covered	46255	Full Covered	46539	Mostly Covered
45157	Mostly Covered	45316	Full Covered	45490	Mostly Covered	46075	Full Covered	46256	Full Covered	46542	Mostly Covered
45158	Mostly Covered	45319	Full Covered	45501	Full Covered	46076	Mostly Covered	46259	Full Covered	46544	Mostly Covered
45160	Full Covered	45320	Full Covered	45502	Full Covered	46077	Mostly Covered	46260	Full Covered	46545	Full Covered
45162	Mostly Covered	45321	Mostly Covered	45503	Full Covered	46082	Full Covered	46266	Full Covered	46546	Full Covered
45174	Full Covered	45323	Full Covered	45504	Full Covered	46104	Full Covered	46268	Full Covered	46554	Mostly Covered
45176	Full Covered	45324	Full Covered	45505	Full Covered	46106	Mostly Covered	46274	Full Covered	46556	Full Covered
45201	Full Covered	45325	Mostly Covered	45506	Full Covered	46107	Full Covered	46275	Full Covered	46561	Full Covered
45202	Full Covered	45326	Mostly Covered	45619	Full Covered	46110	Mostly Covered	46277	Full Covered	46562	Mostly Covered
45203	Full Covered	45327	Mostly Covered	45621	Full Covered	46111	Mostly Covered	46278	Full Covered	46563	Full Covered
45204	Full Covered	45330	Mostly Covered	45630	Full Covered	46112	Mostly Covered	46280	Full Covered	46572	Full Covered
45205	Full Covered	45332	Mostly Covered	45633	Mostly Covered	46113	Full Covered	46282	Full Covered	46573	Full Covered
45206	Full Covered	45335	Mostly Covered	45634	Mostly Covered	46115	Mostly Covered	46283	Full Covered	46574	Mostly Covered
45207	Full Covered	45338	Mostly Covered	45640	Full Covered	46123	Mostly Covered	46285	Full Covered	46580	Full Covered
45208	Full Covered	45339	Mostly Covered	45644	Mostly Covered	46124	Full Covered	46290	Full Covered	46581	Full Covered
45209	Full Covered	45341	Full Covered	45645	Mostly Covered	46126	Mostly Covered	46291	Full Covered	46582	Full Covered
45210	Full Covered	45342	Full Covered	45652	Mostly Covered	46127	Mostly Covered	46295	Full Covered	46590	Full Covered

Zip Code	Coverage Level	Zip Code	Coverage Level	Zip Code	Coverage Level	Zip Code	Coverage Level	Zip Code	Coverage Level	Zip Code	Coverage Level
46595	Mostly Covered	46899	Full Covered	47240	Mostly Covered	47549	Full Covered	47870	Full Covered	48074	Full Covered
46601	Full Covered	46901	Full Covered	47244	Mostly Covered	47557	Mostly Covered	47871	Mostly Covered	48075	Full Covered
46604	Full Covered	46902	Full Covered	47245	Full Covered	47558	Mostly Covered	47876	Full Covered	48076	Full Covered
46613	Full Covered	46903	Full Covered	47246	Mostly Covered	47561	Mostly Covered	47878	Mostly Covered	48079	Mostly Covered
46614	Full Covered	46904	Full Covered	47247	Full Covered	47564	Mostly Covered	47879	Mostly Covered	48080	Full Covered
46615	Full Covered	46914	Mostly Covered	47263	Full Covered	47567	Full Covered	47880	Full Covered	48081	Full Covered
46616	Full Covered	46928	Mostly Covered	47265	Mostly Covered	47568	Mostly Covered	47884	Full Covered	48082	Full Covered
46617	Full Covered	46930	Full Covered	47270	Mostly Covered	47573	Mostly Covered	47885	Full Covered	48083	Full Covered
46619	Full Covered	46933	Full Covered	47272	Full Covered	47575	Mostly Covered	47901	Full Covered	48084	Full Covered
46620	Full Covered	46936	Mostly Covered	47273	Full Covered	47580	Mostly Covered	47902	Full Covered	48085	Full Covered
46624	Full Covered	46937	Full Covered	47274	Mostly Covered	47584	Mostly Covered	47903	Full Covered	48086	Full Covered
46626	Full Covered	46938	Mostly Covered	47280	Mostly Covered	47590	Mostly Covered	47904	Full Covered	48088	Full Covered
46628	Full Covered	46940	Full Covered	47283	Mostly Covered	47591	Full Covered	47905	Mostly Covered	48089	Full Covered
46629	Full Covered	46952	Full Covered	47302	Full Covered	47597	Mostly Covered	47906	Full Covered	48090	Full Covered
46634	Full Covered	46953	Full Covered	47303	Mostly Covered	47598	Full Covered	47907	Full Covered	48091	Full Covered
46635	Full Covered	46957	Full Covered	47304	Full Covered	47612	Mostly Covered	47909	Mostly Covered	48092	Full Covered
46637	Full Covered	46959	Mostly Covered	47305	Full Covered	47616	Full Covered	47920	Mostly Covered	48093	Full Covered
46660	Full Covered	46965	Full Covered	47306	Full Covered	47618	Full Covered	47923	Mostly Covered	48094	Full Covered
46680	Full Covered	46982	Mostly Covered	47307	Full Covered	47629	Full Covered	47924	Mostly Covered	48095	Full Covered
46702	Mostly Covered	46987	Full Covered	47308	Full Covered	47630	Mostly Covered	47933	Full Covered	48096	Full Covered
46703	Full Covered	46989	Full Covered	47322	Mostly Covered	47631	Mostly Covered	47934	Full Covered	48098	Full Covered
46704	Mostly Covered	46991	Mostly Covered	47324	Full Covered	47635	Mostly Covered	47935	Full Covered	48099	Full Covered
46705	Full Covered	46995	Mostly Covered	47325	Mostly Covered	47638	Mostly Covered	47936	Full Covered	48101	Full Covered
46713	Mostly Covered	47001	Full Covered	47327	Mostly Covered	47639	Full Covered	47937	Full Covered	48102	Full Covered
46723	Mostly Covered	47006	Full Covered	47330	Mostly Covered	47640	Mostly Covered	47938	Full Covered	48103	Full Covered
46725	Full Covered	47016	Mostly Covered	47331	Full Covered	47648	Full Covered	47939	Full Covered	48104	Full Covered
46737	Mostly Covered	47022	Mostly Covered	47334	Full Covered	47649	Mostly Covered	47940	Mostly Covered	48105	Full Covered
46742	Mostly Covered	47024	Mostly Covered	47335	Mostly Covered	47660	Mostly Covered	47941	Mostly Covered	48106	Full Covered
46745	Mostly Covered	47025	Full Covered	47337	Mostly Covered	47665	Full Covered	47955	Full Covered	48107	Full Covered
46747	Mostly Covered	47030	Mostly Covered	47338	Mostly Covered	47666	Full Covered	47962	Full Covered	48108	Full Covered
46750	Full Covered	47031	Mostly Covered	47341	Mostly Covered	47670	Full Covered	47965	Mostly Covered	48109	Full Covered
46764	Mostly Covered	47032	Mostly Covered	47342	Full Covered	47683	Mostly Covered	47967	Full Covered	48110	Full Covered
46770	Mostly Covered	47033	Full Covered	47344	Full Covered	47701	Full Covered	47981	Full Covered	48111	Full Covered
46774	Mostly Covered	47034	Mostly Covered	47348	Mostly Covered	47702	Full Covered	47990	Mostly Covered	48112	Full Covered
46776	Mostly Covered	47035	Full Covered	47351	Mostly Covered	47703	Full Covered	47992	Mostly Covered	48113	Full Covered
46779	Full Covered	47036	Full Covered	47352	Mostly Covered	47704	Full Covered	47994	Mostly Covered	48114	Full Covered
46783	Mostly Covered	47037	Mostly Covered	47356	Mostly Covered	47705	Full Covered	47996	Full Covered	48115	Mostly Covered
46787	Mostly Covered	47038	Mostly Covered	47357	Full Covered	47706	Full Covered	48002	Mostly Covered	48116	Full Covered
46789	Mostly Covered	47039	Mostly Covered	47360	Mostly Covered	47708	Full Covered	48003	Mostly Covered	48117	Full Covered
46793	Mostly Covered	47040	Mostly Covered	47361	Full Covered	47710	Full Covered	48004	Mostly Covered	48118	Full Covered
46798	Mostly Covered	47041	Mostly Covered	47362	Full Covered	47711	Full Covered	48005	Full Covered	48120	Full Covered
46799	Mostly Covered	47060	Full Covered	47366	Mostly Covered	47712	Full Covered	48007	Full Covered	48121	Full Covered
46801	Full Covered	47102	Mostly Covered	47367	Full Covered	47713	Full Covered	48009	Full Covered	48122	Full Covered
46802	Full Covered	47104	Full Covered	47370	Mostly Covered	47714	Full Covered	48012	Full Covered	48123	Full Covered
46803	Full Covered	47106	Full Covered	47374	Full Covered	47715	Full Covered	48015	Full Covered	48124	Full Covered
46804	Full Covered	47110	Mostly Covered	47375	Full Covered	47716	Full Covered	48017	Full Covered	48125	Full Covered
46805	Full Covered	47112	Full Covered	47383	Mostly Covered	47719	Full Covered	48021	Full Covered	48126	Full Covered
46806	Full Covered	47114	Full Covered	47385	Mostly Covered	47720	Full Covered	48023	Mostly Covered	48127	Full Covered
46807	Full Covered	47115	Mostly Covered	47386	Full Covered	47721	Full Covered	48025	Full Covered	48128	Full Covered
46808	Full Covered	47117	Full Covered	47387	Mostly Covered	47722	Full Covered	48026	Full Covered	48130	Mostly Covered
46809	Full Covered	47119	Full Covered	47388	Full Covered	47724	Full Covered	48027	Mostly Covered	48131	Mostly Covered
46814	Mostly Covered	47122	Mostly Covered	47392	Full Covered	47725	Full Covered	48030	Full Covered	48133	Mostly Covered
46815	Full Covered	47124	Mostly Covered	47396	Full Covered	47727	Full Covered	48034	Full Covered	48134	Full Covered
46816	Full Covered	47126	Full Covered	47401	Full Covered	47728	Full Covered	48035	Full Covered	48135	Full Covered
46818	Mostly Covered	47129	Full Covered	47402	Full Covered	47730	Full Covered	48036	Full Covered	48136	Full Covered
46819	Full Covered	47130	Full Covered	47403	Mostly Covered	47731	Full Covered	48037	Full Covered	48137	Mostly Covered
46825	Full Covered	47131	Full Covered	47404	Mostly Covered	47732	Full Covered	48038	Full Covered	48138	Full Covered
46835	Full Covered	47135	Full Covered	47405	Full Covered	47733	Full Covered	48040	Full Covered	48139	Mostly Covered
46845	Mostly Covered	47136	Full Covered	47406	Full Covered	47734	Full Covered	48041	Mostly Covered	48141	Full Covered
46850	Full Covered	47138	Mostly Covered	47407	Full Covered	47735	Full Covered	48042	Full Covered	48143	Mostly Covered
46851	Full Covered	47141	Mostly Covered	47408	Full Covered	47736	Full Covered	48043	Full Covered	48144	Mostly Covered
46852	Full Covered	47142	Full Covered	47420	Full Covered	47737	Full Covered	48044	Full Covered	48145	Mostly Covered
46853	Full Covered	47143	Full Covered	47421	Full Covered	47739	Full Covered	48045	Full Covered	48146	Full Covered
46854	Full Covered	47146	Full Covered	47426	Full Covered	47740	Full Covered	48046	Full Covered	48150	Full Covered
46855	Full Covered	47147	Mostly Covered	47434	Mostly Covered	47741	Full Covered	48047	Full Covered	48151	Full Covered
46856	Full Covered	47150	Full Covered	47436	Mostly Covered	47744	Full Covered	48048	Full Covered	48152	Full Covered
46857	Full Covered	47151	Full Covered	47446	Mostly Covered	47747	Full Covered	48049	Mostly Covered	48153	Full Covered
46858	Full Covered	47160	Full Covered	47451	Full Covered	47750	Full Covered	48050	Full Covered	48154	Full Covered
46859	Full Covered	47161	Mostly Covered	47458	Full Covered	47801	Full Covered	48051	Full Covered	48157	Full Covered
46860	Full Covered	47162	Full Covered	47462	Mostly Covered	47802	Full Covered	48059	Mostly Covered	48158	Mostly Covered
46861	Full Covered	47163	Full Covered	47467	Mostly Covered	47803	Mostly Covered	48060	Full Covered	48159	Mostly Covered
46862	Full Covered	47166	Full Covered	47468	Mostly Covered	47804	Full Covered	48061	Full Covered	48160	Full Covered
46863	Full Covered	47170	Mostly Covered	47470	Mostly Covered	47805	Mostly Covered	48062	Full Covered	48161	Full Covered
46864	Full Covered	47172	Full Covered	47490	Full Covered	47807	Mostly Covered	48063	Full Covered	48162	Full Covered
46865	Full Covered	47177	Full Covered	47501	Full Covered	47808	Full Covered	48064	Full Covered	48164	Full Covered
46866	Full Covered	47199	Full Covered	47512	Mostly Covered	47809	Full Covered	48065	Full Covered	48165	Full Covered
46867	Full Covered	47202	Full Covered	47516	Full Covered	47811	Full Covered	48066	Full Covered	48166	Full Covered
46868	Full Covered	47203	Full Covered	47524	Mostly Covered	47812	Full Covered	48067	Full Covered	48167	Full Covered
46869	Full Covered	47225	Mostly Covered	47532	Mostly Covered	47842	Mostly Covered	48068	Full Covered	48169	Full Covered
46885	Full Covered	47226	Full Covered	47541	Mostly Covered	47849	Mostly Covered	48069	Full Covered	48170	Full Covered
46895	Full Covered	47228	Mostly Covered	47542	Full Covered	47850	Full Covered	48070	Full Covered	48173	Full Covered
46896	Full Covered	47232	Full Covered	47545	Full Covered	47863	Full Covered	48071	Full Covered	48174	Full Covered
46897	Full Covered	47234	Mostly Covered	47546	Full Covered	47866	Mostly Covered	48072	Full Covered	48175	Mostly Covered
46898	Full Covered	47236	Full Covered	47547	Full Covered	47869	Full Covered	48073	Full Covered	48176	Full Covered

Zip Code	Coverage Level	Zip Code	Coverage Level	Zip Code	Coverage Level	Zip Code	Coverage Level	Zip Code	Coverage Level	Zip Code	Coverage Level
48177	Mostly Covered	48311	Full Covered	48502	Full Covered	48878	Mostly Covered	49103	Mostly Covered	49444	Full Covered
48178	Full Covered	48312	Full Covered	48503	Full Covered	48880	Full Covered	49104	Full Covered	49445	Full Covered
48179	Full Covered	48313	Full Covered	48504	Full Covered	48882	Full Covered	49111	Full Covered	49448	Full Covered
48180	Full Covered	48314	Full Covered	48505	Full Covered	48883	Full Covered	49112	Mostly Covered	49449	Mostly Covered
48182	Mostly Covered	48315	Full Covered	48506	Full Covered	48885	Mostly Covered	49117	Mostly Covered	49454	Full Covered
48183	Full Covered	48316	Full Covered	48507	Full Covered	48887	Full Covered	49121	Mostly Covered	49456	Full Covered
48184	Full Covered	48317	Full Covered	48509	Full Covered	48895	Full Covered	49126	Full Covered	49457	Mostly Covered
48185	Full Covered	48318	Full Covered	48519	Full Covered	48896	Mostly Covered	49127	Mostly Covered	49460	Mostly Covered
48186	Full Covered	48320	Full Covered	48529	Full Covered	48901	Full Covered	49201	Full Covered	49464	Full Covered
48187	Full Covered	48321	Full Covered	48531	Full Covered	48906	Full Covered	49202	Full Covered	49468	Full Covered
48188	Full Covered	48322	Full Covered	48532	Mostly Covered	48908	Full Covered	49203	Full Covered	49501	Full Covered
48189	Mostly Covered	48323	Full Covered	48550	Full Covered	48909	Full Covered	49204	Full Covered	49502	Full Covered
48190	Full Covered	48324	Full Covered	48551	Full Covered	48910	Full Covered	49221	Full Covered	49503	Full Covered
48191	Full Covered	48325	Full Covered	48552	Full Covered	48911	Full Covered	49234	Mostly Covered	49504	Full Covered
48192	Full Covered	48326	Full Covered	48553	Full Covered	48912	Full Covered	49235	Full Covered	49505	Full Covered
48195	Full Covered	48327	Full Covered	48554	Full Covered	48913	Mostly Covered	49240	Mostly Covered	49506	Full Covered
48197	Full Covered	48328	Full Covered	48555	Full Covered	48915	Full Covered	49245	Mostly Covered	49507	Full Covered
48198	Full Covered	48329	Full Covered	48556	Full Covered	48916	Full Covered	49246	Mostly Covered	49508	Full Covered
48201	Full Covered	48330	Full Covered	48557	Full Covered	48917	Full Covered	49251	Mostly Covered	49509	Full Covered
48202	Full Covered	48331	Full Covered	48601	Full Covered	48918	Mostly Covered	49253	Mostly Covered	49510	Full Covered
48203	Full Covered	48332	Full Covered	48602	Full Covered	48919	Full Covered	49254	Full Covered	49512	Full Covered
48204	Full Covered	48333	Full Covered	48603	Mostly Covered	48921	Full Covered	49261	Full Covered	49514	Full Covered
48205	Full Covered	48334	Full Covered	48604	Full Covered	48922	Full Covered	49265	Full Covered	49515	Full Covered
48206	Full Covered	48335	Full Covered	48605	Full Covered	48924	Full Covered	49267	Mostly Covered	49516	Full Covered
48207	Full Covered	48336	Full Covered	48606	Full Covered	48929	Full Covered	49272	Mostly Covered	49518	Full Covered
48208	Full Covered	48340	Full Covered	48607	Full Covered	48930	Full Covered	49275	Mostly Covered	49523	Full Covered
48209	Full Covered	48341	Full Covered	48608	Full Covered	48933	Full Covered	49276	Mostly Covered	49525	Full Covered
48210	Full Covered	48342	Full Covered	48609	Mostly Covered	48937	Full Covered	49277	Mostly Covered	49530	Full Covered
48211	Full Covered	48343	Full Covered	48611	Full Covered	48950	Full Covered	49279	Mostly Covered	49544	Full Covered
48212	Full Covered	48346	Full Covered	48615	Mostly Covered	48951	Full Covered	49282	Mostly Covered	49546	Full Covered
48213	Full Covered	48347	Full Covered	48623	Mostly Covered	48956	Full Covered	49283	Mostly Covered	49548	Full Covered
48214	Full Covered	48348	Full Covered	48626	Mostly Covered	48980	Mostly Covered	49287	Full Covered	49550	Full Covered
48215	Full Covered	48350	Full Covered	48631	Full Covered	49001	Full Covered	49289	Full Covered	49555	Full Covered
48216	Full Covered	48353	Full Covered	48634	Full Covered	49002	Full Covered	49301	Full Covered	49560	Full Covered
48217	Full Covered	48356	Mostly Covered	48637	Mostly Covered	49003	Full Covered	49302	Full Covered	49588	Full Covered
48218	Full Covered	48357	Full Covered	48640	Full Covered	49004	Full Covered	49303	Mostly Covered	49599	Full Covered
48219	Full Covered	48359	Full Covered	48641	Full Covered	49005	Full Covered	49306	Full Covered	49610	Mostly Covered
48220	Full Covered	48360	Full Covered	48642	Mostly Covered	49006	Full Covered	49311	Full Covered	49621	Mostly Covered
48221	Full Covered	48361	Full Covered	48650	Mostly Covered	49007	Full Covered	49314	Mostly Covered	49637	Mostly Covered
48222	Full Covered	48362	Full Covered	48663	Full Covered	49008	Full Covered	49315	Full Covered	49684	Full Covered
48223	Full Covered	48363	Full Covered	48667	Full Covered	49009	Full Covered	49316	Full Covered	49685	Full Covered
48224	Full Covered	48366	Mostly Covered	48670	Full Covered	49012	Full Covered	49317	Mostly Covered	49686	Mostly Covered
48225	Full Covered	48367	Mostly Covered	48674	Full Covered	49014	Full Covered	49319	Mostly Covered	49696	Full Covered
48226	Full Covered	48370	Mostly Covered	48686	Full Covered	49015	Full Covered	49321	Full Covered	49707	Full Covered
48227	Full Covered	48371	Full Covered	48706	Full Covered	49016	Full Covered	49323	Mostly Covered	49766	Mostly Covered
48228	Full Covered	48374	Full Covered	48707	Full Covered	49017	Full Covered	49326	Full Covered	50003	Full Covered
48229	Full Covered	48375	Full Covered	48708	Full Covered	49018	Full Covered	49327	Full Covered	50007	Full Covered
48230	Full Covered	48376	Full Covered	48710	Mostly Covered	49019	Full Covered	49328	Mostly Covered	50009	Full Covered
48231	Full Covered	48377	Full Covered	48722	Full Covered	49020	Full Covered	49331	Mostly Covered	50010	Full Covered
48232	Full Covered	48380	Full Covered	48724	Full Covered	49021	Mostly Covered	49335	Full Covered	50011	Full Covered
48233	Full Covered	48381	Full Covered	48732	Full Covered	49022	Full Covered	49337	Full Covered	50012	Full Covered
48234	Full Covered	48382	Full Covered	48747	Mostly Covered	49023	Full Covered	49341	Full Covered	50013	Full Covered
48235	Full Covered	48383	Full Covered	48787	Mostly Covered	49024	Full Covered	49345	Mostly Covered	50014	Mostly Covered
48236	Full Covered	48386	Full Covered	48801	Full Covered	49032	Mostly Covered	49347	Mostly Covered	50021	Full Covered
48237	Full Covered	48387	Mostly Covered	48802	Full Covered	49033	Mostly Covered	49348	Full Covered	50028	Mostly Covered
48238	Full Covered	48390	Full Covered	48804	Full Covered	49034	Mostly Covered	49349	Mostly Covered	50032	Full Covered
48239	Full Covered	48391	Full Covered	48805	Full Covered	49038	Mostly Covered	49351	Full Covered	50033	Mostly Covered
48240	Full Covered	48393	Full Covered	48808	Mostly Covered	49039	Mostly Covered	49355	Full Covered	50035	Mostly Covered
48242	Full Covered	48397	Full Covered	48809	Full Covered	49041	Full Covered	49356	Full Covered	50038	Mostly Covered
48243	Full Covered	48398	Full Covered	48816	Mostly Covered	49042	Full Covered	49357	Full Covered	50046	Full Covered
48244	Full Covered	48411	Mostly Covered	48819	Mostly Covered	49048	Full Covered	49401	Mostly Covered	50047	Mostly Covered
48255	Full Covered	48415	Full Covered	48820	Mostly Covered	49051	Mostly Covered	49405	Mostly Covered	50061	Full Covered
48260	Full Covered	48417	Mostly Covered	48821	Mostly Covered	49053	Full Covered	49409	Full Covered	50063	Mostly Covered
48264	Full Covered	48418	Mostly Covered	48823	Full Covered	49060	Full Covered	49412	Full Covered	50069	Full Covered
48265	Full Covered	48420	Mostly Covered	48824	Full Covered	49061	Mostly Covered	49413	Full Covered	50072	Mostly Covered
48266	Full Covered	48423	Mostly Covered	48825	Full Covered	49068	Full Covered	49415	Full Covered	50073	Full Covered
48267	Full Covered	48428	Mostly Covered	48826	Full Covered	49069	Full Covered	49417	Full Covered	50105	Mostly Covered
48268	Full Covered	48430	Full Covered	48832	Mostly Covered	49071	Mostly Covered	49418	Mostly Covered	50111	Mostly Covered
48269	Full Covered	48433	Full Covered	48836	Mostly Covered	49074	Full Covered	49419	Mostly Covered	50124	Full Covered
48272	Full Covered	48436	Full Covered	48838	Full Covered	49076	Mostly Covered	49421	Mostly Covered	50127	Mostly Covered
48275	Full Covered	48437	Full Covered	48840	Full Covered	49077	Full Covered	49422	Mostly Covered	50131	Mostly Covered
48277	Full Covered	48438	Mostly Covered	48842	Full Covered	49080	Mostly Covered	49423	Mostly Covered	50134	Mostly Covered
48278	Full Covered	48439	Full Covered	48843	Full Covered	49081	Full Covered	49424	Mostly Covered	50135	Mostly Covered
48279	Full Covered	48440	Full Covered	48844	Full Covered	49083	Full Covered	49425	Mostly Covered	50137	Mostly Covered
48288	Full Covered	48442	Full Covered	48847	Mostly Covered	49084	Mostly Covered	49426	Full Covered	50167	Mostly Covered
48301	Full Covered	48446	Mostly Covered	48848	Mostly Covered	49085	Full Covered	49427	Full Covered	50201	Full Covered
48302	Full Covered	48451	Full Covered	48854	Full Covered	49087	Mostly Covered	49428	Mostly Covered	50208	Full Covered
48303	Full Covered	48455	Full Covered	48855	Mostly Covered	49088	Mostly Covered	49429	Mostly Covered	50211	Mostly Covered
48304	Full Covered	48457	Full Covered	48858	Full Covered	49092	Mostly Covered	49431	Full Covered	50226	Full Covered
48306	Full Covered	48458	Mostly Covered	48859	Full Covered	49093	Full Covered	49435	Mostly Covered	50232	Mostly Covered
48307	Full Covered	48460	Mostly Covered	48862	Mostly Covered	49098	Mostly Covered	49440	Full Covered	50233	Mostly Covered
48308	Full Covered	48462	Full Covered	48863	Mostly Covered	49099	Mostly Covered	49441	Full Covered	50236	Mostly Covered
48309	Full Covered	48473	Full Covered	48864	Full Covered	49101	Mostly Covered	49442	Full Covered	50237	Mostly Covered
48310	Full Covered	48501	Full Covered	48872	Mostly Covered	49102	Mostly Covered	49443	Full Covered	50243	Full Covered

Zip Code	Coverage Level	Zip Code	Coverage Level	Zip Code	Coverage Level	Zip Code	Coverage Level	Zip Code	Coverage Level	Zip Code	Coverage Level
50244	Full Covered	51503	Full Covered	52778	Mostly Covered	53148	Full Covered	53528	Mostly Covered	54169	Full Covered
50261	Mostly Covered	51510	Full Covered	52801	Full Covered	53149	Mostly Covered	53531	Mostly Covered	54173	Mostly Covered
50263	Full Covered	51526	Mostly Covered	52802	Full Covered	53150	Full Covered	53532	Mostly Covered	54214	Mostly Covered
50265	Full Covered	51534	Full Covered	52803	Full Covered	53151	Full Covered	53534	Mostly Covered	54220	Mostly Covered
50266	Full Covered	51542	Mostly Covered	52804	Full Covered	53153	Full Covered	53536	Mostly Covered	54221	Mostly Covered
50301	Full Covered	51554	Full Covered	52805	Full Covered	53154	Full Covered	53537	Mostly Covered	54228	Mostly Covered
50302	Full Covered	51561	Full Covered	52806	Full Covered	53157	Full Covered	53542	Mostly Covered	54232	Mostly Covered
50303	Full Covered	51571	Mostly Covered	52807	Full Covered	53158	Full Covered	53545	Mostly Covered	54240	Mostly Covered
50304	Full Covered	51576	Mostly Covered	52808	Full Covered	53159	Mostly Covered	53547	Mostly Covered	54241	Full Covered
50305	Full Covered	52001	Full Covered	52809	Full Covered	53171	Full Covered	53548	Full Covered	54245	Mostly Covered
50306	Full Covered	52002	Full Covered	53003	Full Covered	53172	Full Covered	53555	Mostly Covered	54301	Full Covered
50309	Full Covered	52003	Full Covered	53005	Full Covered	53176	Full Covered	53557	Mostly Covered	54302	Full Covered
50310	Full Covered	52004	Full Covered	53006	Full Covered	53177	Full Covered	53558	Full Covered	54303	Full Covered
50311	Full Covered	52039	Mostly Covered	53007	Full Covered	53178	Mostly Covered	53561	Full Covered	54304	Full Covered
50312	Full Covered	52068	Full Covered	53008	Full Covered	53183	Full Covered	53562	Full Covered	54305	Full Covered
50313	Full Covered	52073	Mostly Covered	53010	Mostly Covered	53184	Mostly Covered	53575	Mostly Covered	54306	Full Covered
50314	Full Covered	52099	Full Covered	53012	Full Covered	53185	Mostly Covered	53576	Full Covered	54307	Full Covered
50315	Full Covered	52202	Mostly Covered	53013	Mostly Covered	53186	Full Covered	53578	Mostly Covered	54308	Full Covered
50316	Full Covered	52227	Mostly Covered	53015	Full Covered	53187	Full Covered	53579	Mostly Covered	54311	Mostly Covered
50317	Full Covered	52228	Full Covered	53017	Mostly Covered	53188	Mostly Covered	53589	Mostly Covered	54313	Mostly Covered
50318	Full Covered	52233	Full Covered	53018	Full Covered	53189	Full Covered	53590	Mostly Covered	54324	Full Covered
50319	Full Covered	52235	Mostly Covered	53019	Mostly Covered	53191	Full Covered	53591	Full Covered	54344	Mostly Covered
50320	Full Covered	52240	Full Covered	53022	Full Covered	53194	Mostly Covered	53593	Full Covered	54401	Full Covered
50321	Full Covered	52241	Full Covered	53024	Full Covered	53195	Full Covered	53596	Full Covered	54402	Full Covered
50322	Full Covered	52242	Full Covered	53029	Mostly Covered	53201	Full Covered	53597	Mostly Covered	54403	Mostly Covered
50323	Full Covered	52243	Full Covered	53031	Full Covered	53202	Full Covered	53598	Mostly Covered	54404	Full Covered
50325	Full Covered	52244	Full Covered	53036	Mostly Covered	53203	Full Covered	53701	Full Covered	54409	Full Covered
50327	Full Covered	52245	Full Covered	53038	Full Covered	53204	Full Covered	53702	Full Covered	54412	Mostly Covered
50328	Full Covered	52246	Full Covered	53044	Full Covered	53205	Full Covered	53703	Full Covered	54414	Mostly Covered
50329	Full Covered	52302	Full Covered	53045	Full Covered	53206	Full Covered	53704	Full Covered	54417	Full Covered
50330	Full Covered	52317	Full Covered	53046	Full Covered	53207	Full Covered	53705	Full Covered	54441	Full Covered
50331	Full Covered	52319	Full Covered	53047	Full Covered	53208	Full Covered	53706	Full Covered	54443	Full Covered
50332	Full Covered	52324	Mostly Covered	53048	Full Covered	53209	Full Covered	53707	Full Covered	54448	Mostly Covered
50333	Full Covered	52328	Full Covered	53050	Mostly Covered	53210	Full Covered	53708	Full Covered	54449	Full Covered
50334	Full Covered	52333	Mostly Covered	53051	Full Covered	53211	Full Covered	53711	Full Covered	54450	Mostly Covered
50335	Full Covered	52338	Mostly Covered	53052	Full Covered	53212	Full Covered	53713	Full Covered	54452	Full Covered
50336	Full Covered	52340	Mostly Covered	53056	Mostly Covered	53213	Full Covered	53714	Full Covered	54455	Mostly Covered
50338	Full Covered	52341	Mostly Covered	53058	Full Covered	53214	Full Covered	53715	Full Covered	54464	Mostly Covered
50339	Full Covered	52351	Mostly Covered	53063	Full Covered	53215	Full Covered	53716	Full Covered	54467	Mostly Covered
50340	Full Covered	52401	Full Covered	53064	Mostly Covered	53216	Full Covered	53717	Full Covered	54472	Full Covered
50347	Full Covered	52402	Full Covered	53065	Mostly Covered	53217	Mostly Covered	53718	Full Covered	54474	Full Covered
50359	Full Covered	52403	Full Covered	53066	Full Covered	53218	Full Covered	53719	Full Covered	54475	Mostly Covered
50360	Full Covered	52404	Full Covered	53069	Full Covered	53219	Full Covered	53725	Full Covered	54476	Full Covered
50361	Full Covered	52405	Full Covered	53070	Full Covered	53220	Full Covered	53726	Full Covered	54481	Full Covered
50362	Full Covered	52406	Full Covered	53072	Mostly Covered	53221	Full Covered	53744	Full Covered	54484	Mostly Covered
50363	Full Covered	52407	Full Covered	53074	Mostly Covered	53222	Full Covered	53774	Full Covered	54492	Mostly Covered
50364	Full Covered	52408	Full Covered	53076	Mostly Covered	53223	Mostly Covered	53777	Full Covered	54501	Full Covered
50367	Full Covered	52409	Full Covered	53080	Full Covered	53224	Full Covered	53778	Full Covered	54543	Full Covered
50368	Full Covered	52410	Full Covered	53081	Full Covered	53225	Full Covered	53779	Full Covered	54601	Full Covered
50369	Full Covered	52411	Full Covered	53082	Full Covered	53226	Full Covered	53782	Full Covered	54602	Full Covered
50380	Full Covered	52497	Full Covered	53083	Mostly Covered	53227	Mostly Covered	53783	Full Covered	54603	Full Covered
50381	Full Covered	52498	Full Covered	53085	Full Covered	53228	Mostly Covered	53784	Full Covered	54614	Mostly Covered
50391	Full Covered	52499	Full Covered	53089	Mostly Covered	53233	Full Covered	53785	Full Covered	54620	Full Covered
50392	Full Covered	52601	Full Covered	53091	Mostly Covered	53234	Full Covered	53786	Full Covered	54621	Mostly Covered
50393	Full Covered	52624	Full Covered	53092	Full Covered	53235	Full Covered	53788	Full Covered	54623	Mostly Covered
50394	Full Covered	52627	Full Covered	53093	Mostly Covered	53237	Full Covered	53789	Full Covered	54629	Mostly Covered
50395	Full Covered	52638	Mostly Covered	53094	Full Covered	53263	Full Covered	53790	Full Covered	54650	Full Covered
50396	Full Covered	52639	Mostly Covered	53097	Full Covered	53267	Full Covered	53791	Full Covered	54653	Mostly Covered
50397	Full Covered	52650	Mostly Covered	53098	Full Covered	53268	Full Covered	53792	Full Covered	54656	Full Covered
50398	Full Covered	52655	Full Covered	53101	Mostly Covered	53270	Full Covered	53793	Full Covered	54658	Mostly Covered
50501	Full Covered	52656	Mostly Covered	53103	Full Covered	53274	Full Covered	53794	Full Covered	54669	Mostly Covered
50516	Mostly Covered	52658	Mostly Covered	53104	Mostly Covered	53277	Full Covered	53812	Mostly Covered	54701	Mostly Covered
50532	Mostly Covered	52722	Full Covered	53105	Mostly Covered	53278	Full Covered	53913	Full Covered	54702	Mostly Covered
50566	Mostly Covered	52726	Full Covered	53108	Full Covered	53280	Full Covered	53919	Full Covered	54703	Mostly Covered
50569	Full Covered	52727	Mostly Covered	53110	Full Covered	53281	Full Covered	53931	Full Covered	54720	Full Covered
50594	Mostly Covered	52728	Full Covered	53118	Full Covered	53284	Full Covered	53933	Mostly Covered	54729	Full Covered
50936	Full Covered	52730	Mostly Covered	53119	Mostly Covered	53285	Full Covered	53940	Full Covered	54730	Full Covered
50940	Full Covered	52732	Full Covered	53121	Mostly Covered	53288	Full Covered	53946	Mostly Covered	54739	Full Covered
50947	Full Covered	52733	Full Covered	53122	Full Covered	53290	Full Covered	53963	Full Covered	54742	Mostly Covered
50950	Full Covered	52736	Full Covered	53125	Mostly Covered	53293	Full Covered	54015	Mostly Covered	54764	Mostly Covered
50980	Full Covered	52745	Mostly Covered	53126	Mostly Covered	53295	Full Covered	54016	Mostly Covered	54774	Full Covered
50981	Full Covered	52746	Mostly Covered	53127	Full Covered	53401	Mostly Covered	54017	Full Covered	54901	Full Covered
51054	Mostly Covered	52747	Mostly Covered	53128	Full Covered	53402	Full Covered	54023	Mostly Covered	54902	Full Covered
51101	Full Covered	52748	Mostly Covered	53129	Mostly Covered	53403	Full Covered	54025	Mostly Covered	54903	Full Covered
51102	Full Covered	52749	Full Covered	53130	Mostly Covered	53404	Full Covered	54026	Full Covered	54904	Full Covered
51103	Full Covered	52753	Full Covered	53132	Mostly Covered	53405	Mostly Covered	54082	Full Covered	54911	Full Covered
51104	Full Covered	52758	Mostly Covered	53138	Mostly Covered	53406	Full Covered	54113	Full Covered	54912	Full Covered
51105	Full Covered	52760	Mostly Covered	53140	Full Covered	53407	Mostly Covered	54115	Mostly Covered	54913	Full Covered
51106	Full Covered	52761	Full Covered	53141	Full Covered	53408	Full Covered	54126	Full Covered	54914	Full Covered
51108	Full Covered	52767	Full Covered	53142	Full Covered	53490	Full Covered	54130	Mostly Covered	54915	Full Covered
51109	Full Covered	52768	Mostly Covered	53143	Full Covered	53501	Full Covered	54131	Full Covered	54919	Full Covered
51111	Full Covered	52769	Mostly Covered	53144	Full Covered	53511	Mostly Covered	54136	Full Covered	54922	Mostly Covered
51501	Full Covered	52771	Full Covered	53146	Full Covered	53512	Mostly Covered	54140	Full Covered	54931	Mostly Covered
51502	Full Covered	52773	Full Covered	53147	Full Covered	53527	Full Covered	54155	Mostly Covered	54935	Mostly Covered

Zip Code	Coverage Level	Zip Code	Coverage Level	Zip Code	Coverage Level	Zip Code	Coverage Level	Zip Code	Coverage Level	Zip Code	Coverage Level
54936	Mostly Covered	55144	Full Covered	55406	Full Covered	55592	Full Covered	56393	Full Covered	59107	Full Covered
54937	Mostly Covered	55146	Full Covered	55407	Full Covered	55593	Full Covered	56395	Full Covered	59108	Full Covered
54941	Mostly Covered	55150	Full Covered	55408	Full Covered	55595	Full Covered	56396	Full Covered	59114	Full Covered
54942	Mostly Covered	55155	Full Covered	55409	Full Covered	55596	Full Covered	56397	Full Covered	59115	Full Covered
54949	Mostly Covered	55161	Full Covered	55410	Full Covered	55597	Full Covered	56398	Full Covered	59116	Mostly Covered
54952	Full Covered	55164	Full Covered	55411	Full Covered	55598	Full Covered	56399	Full Covered	59117	Full Covered
54956	Mostly Covered	55165	Full Covered	55412	Full Covered	55599	Full Covered	56401	Full Covered	59401	Full Covered
54957	Full Covered	55166	Full Covered	55413	Full Covered	55701	Mostly Covered	56425	Mostly Covered	59402	Full Covered
54961	Full Covered	55168	Full Covered	55414	Full Covered	55708	Mostly Covered	56449	Mostly Covered	59403	Full Covered
54969	Mostly Covered	55169	Full Covered	55415	Full Covered	55734	Mostly Covered	56529	Full Covered	59404	Full Covered
54971	Full Covered	55170	Full Covered	55416	Full Covered	55741	Mostly Covered	56560	Full Covered	59406	Full Covered
54974	Mostly Covered	55172	Full Covered	55417	Full Covered	55751	Mostly Covered	56561	Full Covered	59414	Full Covered
54975	Full Covered	55175	Full Covered	55418	Full Covered	55768	Mostly Covered	56562	Full Covered	59472	Mostly Covered
54979	Mostly Covered	55177	Full Covered	55419	Full Covered	55777	Full Covered	56563	Full Covered	59801	Full Covered
54983	Mostly Covered	55182	Full Covered	55420	Full Covered	55792	Mostly Covered	56721	Full Covered	59803	Full Covered
54985	Full Covered	55187	Full Covered	55421	Full Covered	55802	Full Covered	57005	Full Covered	59806	Full Covered
55001	Full Covered	55188	Full Covered	55422	Full Covered	55805	Full Covered	57032	Full Covered	59807	Full Covered
55003	Full Covered	55190	Full Covered	55423	Full Covered	55806	Full Covered	57038	Full Covered	59812	Full Covered
55010	Full Covered	55191	Full Covered	55424	Full Covered	55807	Full Covered	57049	Full Covered	59851	Full Covered
55013	Full Covered	55199	Full Covered	55425	Full Covered	55808	Mostly Covered	57055	Mostly Covered	60001	Mostly Covered
55014	Full Covered	55301	Full Covered	55426	Full Covered	55810	Mostly Covered	57056	Full Covered	60004	Full Covered
55016	Full Covered	55303	Full Covered	55427	Full Covered	55811	Full Covered	57068	Mostly Covered	60005	Full Covered
55019	Full Covered	55304	Mostly Covered	55428	Full Covered	55812	Full Covered	57101	Full Covered	60006	Full Covered
55020	Full Covered	55305	Full Covered	55429	Full Covered	55814	Full Covered	57103	Full Covered	60007	Full Covered
55024	Mostly Covered	55306	Full Covered	55430	Full Covered	55815	Full Covered	57104	Full Covered	60008	Full Covered
55025	Full Covered	55308	Mostly Covered	55431	Full Covered	55816	Full Covered	57105	Full Covered	60009	Full Covered
55032	Full Covered	55309	Mostly Covered	55432	Full Covered	55901	Full Covered	57106	Mostly Covered	60010	Full Covered
55038	Full Covered	55311	Full Covered	55433	Full Covered	55902	Full Covered	57107	Mostly Covered	60011	Full Covered
55042	Full Covered	55312	Mostly Covered	55434	Full Covered	55903	Full Covered	57108	Full Covered	60012	Full Covered
55043	Full Covered	55313	Full Covered	55435	Full Covered	55904	Mostly Covered	57109	Full Covered	60013	Full Covered
55044	Full Covered	55315	Mostly Covered	55436	Full Covered	55905	Full Covered	57110	Full Covered	60014	Full Covered
55045	Mostly Covered	55316	Full Covered	55437	Full Covered	55906	Mostly Covered	57117	Full Covered	60015	Full Covered
55046	Mostly Covered	55317	Full Covered	55438	Full Covered	55912	Full Covered	57118	Full Covered	60016	Full Covered
55047	Mostly Covered	55318	Full Covered	55439	Full Covered	55918	Mostly Covered	57186	Full Covered	60017	Full Covered
55053	Mostly Covered	55322	Mostly Covered	55440	Full Covered	55920	Full Covered	57188	Full Covered	60018	Full Covered
55054	Full Covered	55323	Full Covered	55441	Full Covered	55941	Mostly Covered	57189	Full Covered	60019	Full Covered
55055	Full Covered	55327	Full Covered	55442	Full Covered	55942	Full Covered	57192	Full Covered	60021	Full Covered
55056	Full Covered	55328	Mostly Covered	55443	Full Covered	55945	Full Covered	57193	Full Covered	60022	Full Covered
55057	Full Covered	55330	Full Covered	55444	Full Covered	55953	Mostly Covered	57194	Full Covered	60025	Full Covered
55060	Mostly Covered	55331	Full Covered	55445	Full Covered	55959	Full Covered	57195	Full Covered	60026	Full Covered
55068	Full Covered	55337	Full Covered	55446	Full Covered	55960	Mostly Covered	57196	Full Covered	60029	Full Covered
55069	Mostly Covered	55338	Mostly Covered	55447	Full Covered	55969	Mostly Covered	57197	Full Covered	60030	Full Covered
55071	Full Covered	55340	Full Covered	55448	Full Covered	55970	Mostly Covered	57701	Full Covered	60031	Full Covered
55073	Mostly Covered	55341	Mostly Covered	55449	Full Covered	55976	Mostly Covered	57702	Mostly Covered	60033	Mostly Covered
55075	Full Covered	55343	Full Covered	55450	Full Covered	55987	Full Covered	57703	Mostly Covered	60034	Mostly Covered
55076	Full Covered	55344	Full Covered	55454	Full Covered	55988	Full Covered	57706	Mostly Covered	60035	Full Covered
55077	Full Covered	55345	Full Covered	55455	Full Covered	56001	Full Covered	57709	Full Covered	60037	Full Covered
55078	Full Covered	55346	Full Covered	55458	Full Covered	56002	Full Covered	57718	Mostly Covered	60038	Full Covered
55079	Full Covered	55347	Full Covered	55459	Full Covered	56003	Full Covered	57769	Mostly Covered	60039	Full Covered
55082	Full Covered	55348	Full Covered	55460	Full Covered	56006	Full Covered	58102	Full Covered	60040	Full Covered
55083	Full Covered	55350	Full Covered	55470	Full Covered	56011	Full Covered	58103	Full Covered	60041	Mostly Covered
55088	Full Covered	55352	Mostly Covered	55472	Full Covered	56026	Mostly Covered	58104	Mostly Covered	60042	Mostly Covered
55090	Full Covered	55356	Full Covered	55474	Full Covered	56034	Mostly Covered	58105	Full Covered	60043	Full Covered
55092	Mostly Covered	55357	Full Covered	55479	Full Covered	56037	Mostly Covered	58106	Full Covered	60044	Full Covered
55101	Full Covered	55358	Mostly Covered	55480	Full Covered	56044	Mostly Covered	58107	Full Covered	60045	Full Covered
55102	Full Covered	55359	Mostly Covered	55483	Full Covered	56046	Full Covered	58108	Full Covered	60046	Mostly Covered
55103	Full Covered	55361	Full Covered	55484	Full Covered	56058	Mostly Covered	58109	Full Covered	60047	Full Covered
55104	Full Covered	55362	Full Covered	55485	Full Covered	56072	Mostly Covered	58121	Full Covered	60048	Full Covered
55105	Full Covered	55363	Mostly Covered	55486	Full Covered	56080	Mostly Covered	58122	Full Covered	60049	Full Covered
55106	Full Covered	55364	Full Covered	55487	Full Covered	56093	Mostly Covered	58124	Full Covered	60050	Mostly Covered
55107	Full Covered	55365	Full Covered	55488	Full Covered	56201	Full Covered	58125	Full Covered	60051	Mostly Covered
55108	Full Covered	55368	Mostly Covered	55561	Full Covered	56209	Mostly Covered	58126	Full Covered	60053	Full Covered
55109	Full Covered	55369	Full Covered	55563	Full Covered	56251	Full Covered	58201	Full Covered	60055	Full Covered
55110	Full Covered	55372	Mostly Covered	55565	Full Covered	56273	Mostly Covered	58202	Full Covered	60056	Full Covered
55111	Full Covered	55373	Mostly Covered	55569	Full Covered	56288	Full Covered	58203	Full Covered	60060	Full Covered
55112	Full Covered	55374	Full Covered	55570	Full Covered	56301	Mostly Covered	58206	Full Covered	60061	Full Covered
55113	Full Covered	55375	Mostly Covered	55571	Full Covered	56302	Full Covered	58208	Full Covered	60062	Full Covered
55114	Full Covered	55376	Full Covered	55572	Full Covered	56303	Full Covered	58278	Mostly Covered	60064	Full Covered
55115	Mostly Covered	55378	Full Covered	55574	Full Covered	56304	Mostly Covered	58501	Full Covered	60065	Full Covered
55116	Full Covered	55379	Full Covered	55576	Full Covered	56308	Full Covered	58502	Full Covered	60067	Full Covered
55117	Full Covered	55381	Mostly Covered	55577	Full Covered	56319	Mostly Covered	58503	Full Covered	60068	Full Covered
55118	Full Covered	55384	Full Covered	55578	Full Covered	56321	Mostly Covered	58504	Mostly Covered	60069	Full Covered
55119	Full Covered	55386	Full Covered	55579	Full Covered	56355	Full Covered	58505	Full Covered	60070	Full Covered
55120	Full Covered	55387	Mostly Covered	55580	Full Covered	56360	Mostly Covered	58506	Full Covered	60073	Mostly Covered
55121	Full Covered	55390	Mostly Covered	55581	Full Covered	56367	Full Covered	58507	Full Covered	60074	Full Covered
55122	Full Covered	55391	Full Covered	55582	Full Covered	56369	Full Covered	58701	Mostly Covered	60075	Mostly Covered
55123	Full Covered	55392	Full Covered	55584	Full Covered	56372	Full Covered	58702	Full Covered	60076	Full Covered
55124	Full Covered	55393	Full Covered	55585	Full Covered	56374	Mostly Covered	58703	Full Covered	60077	Full Covered
55125	Full Covered	55398	Full Covered	55586	Full Covered	56375	Mostly Covered	58707	Full Covered	60078	Full Covered
55126	Full Covered	55401	Full Covered	55587	Full Covered	56377	Full Covered	59101	Mostly Covered	60079	Full Covered
55127	Full Covered	55402	Full Covered	55588	Full Covered	56379	Full Covered	59102	Mostly Covered	60082	Full Covered
55128	Full Covered	55403	Full Covered	55589	Full Covered	56385	Mostly Covered	59103	Full Covered	60083	Mostly Covered
55129	Full Covered	55404	Full Covered	55590	Full Covered	56387	Mostly Covered	59104	Full Covered	60084	Full Covered
55133	Full Covered	55405	Full Covered	55591	Full Covered	56388	Full Covered	59105	Mostly Covered	60085	Full Covered

Zip Code	Coverage Level	Zip Code	Coverage Level	Zip Code	Coverage Level	Zip Code	Coverage Level	Zip Code	Coverage Level	Zip Code	Coverage Level
60086	Full Covered	60183	Full Covered	60469	Full Covered	60625	Full Covered	61018	Full Covered	61348	Full Covered
60087	Full Covered	60184	Mostly Covered	60471	Full Covered	60626	Full Covered	61020	Mostly Covered	61349	Mostly Covered
60088	Full Covered	60185	Full Covered	60472	Full Covered	60628	Full Covered	61024	Mostly Covered	61350	Full Covered
60089	Full Covered	60186	Full Covered	60473	Full Covered	60629	Full Covered	61027	Mostly Covered	61356	Full Covered
60090	Full Covered	60187	Full Covered	60475	Full Covered	60630	Full Covered	61032	Full Covered	61368	Full Covered
60091	Full Covered	60188	Full Covered	60476	Full Covered	60631	Full Covered	61037	Full Covered	61370	Mostly Covered
60092	Full Covered	60189	Full Covered	60477	Full Covered	60632	Full Covered	61038	Mostly Covered	61373	Full Covered
60093	Full Covered	60190	Full Covered	60478	Full Covered	60633	Full Covered	61043	Full Covered	61379	Full Covered
60094	Full Covered	60191	Full Covered	60480	Full Covered	60634	Full Covered	61049	Full Covered	61417	Mostly Covered
60095	Full Covered	60192	Full Covered	60482	Full Covered	60636	Full Covered	61050	Mostly Covered	61423	Full Covered
60096	Mostly Covered	60193	Full Covered	60490	Full Covered	60637	Full Covered	61052	Full Covered	61425	Full Covered
60097	Mostly Covered	60194	Full Covered	60491	Full Covered	60638	Full Covered	61060	Mostly Covered	61434	Mostly Covered
60098	Full Covered	60195	Full Covered	60499	Full Covered	60639	Full Covered	61065	Mostly Covered	61435	Mostly Covered
60099	Full Covered	60196	Full Covered	60501	Full Covered	60640	Full Covered	61067	Mostly Covered	61437	Mostly Covered
60101	Full Covered	60197	Full Covered	60504	Full Covered	60641	Full Covered	61068	Full Covered	61443	Full Covered
60102	Full Covered	60199	Full Covered	60505	Full Covered	60643	Full Covered	61070	Mostly Covered	61447	Mostly Covered
60103	Full Covered	60201	Full Covered	60506	Full Covered	60644	Full Covered	61071	Full Covered	61449	Mostly Covered
60104	Full Covered	60202	Full Covered	60507	Full Covered	60645	Full Covered	61072	Full Covered	61453	Mostly Covered
60106	Full Covered	60203	Full Covered	60510	Full Covered	60646	Full Covered	61073	Full Covered	61454	Mostly Covered
60107	Full Covered	60204	Full Covered	60513	Full Covered	60647	Full Covered	61079	Full Covered	61462	Full Covered
60108	Full Covered	60208	Full Covered	60514	Full Covered	60649	Full Covered	61080	Mostly Covered	61480	Mostly Covered
60109	Full Covered	60209	Full Covered	60515	Full Covered	60651	Full Covered	61081	Full Covered	61483	Mostly Covered
60110	Full Covered	60301	Full Covered	60516	Full Covered	60652	Full Covered	61084	Mostly Covered	61517	Mostly Covered
60111	Mostly Covered	60302	Full Covered	60517	Full Covered	60653	Full Covered	61088	Mostly Covered	61525	Full Covered
60112	Full Covered	60303	Full Covered	60519	Full Covered	60654	Full Covered	61101	Full Covered	61528	Full Covered
60113	Full Covered	60304	Full Covered	60520	Mostly Covered	60655	Full Covered	61102	Full Covered	61535	Full Covered
60115	Full Covered	60305	Full Covered	60521	Full Covered	60656	Full Covered	61103	Full Covered	61536	Full Covered
60116	Full Covered	60398	Full Covered	60522	Full Covered	60657	Full Covered	61104	Full Covered	61547	Mostly Covered
60117	Full Covered	60399	Full Covered	60523	Full Covered	60659	Full Covered	61105	Full Covered	61550	Mostly Covered
60118	Full Covered	60401	Full Covered	60525	Full Covered	60660	Full Covered	61106	Full Covered	61552	Mostly Covered
60119	Mostly Covered	60402	Full Covered	60526	Full Covered	60661	Full Covered	61107	Full Covered	61554	Full Covered
60120	Mostly Covered	60406	Full Covered	60527	Full Covered	60663	Full Covered	61108	Full Covered	61555	Full Covered
60121	Full Covered	60407	Mostly Covered	60530	Mostly Covered	60664	Full Covered	61109	Full Covered	61558	Full Covered
60123	Full Covered	60408	Mostly Covered	60532	Full Covered	60665	Full Covered	61110	Full Covered	61559	Mostly Covered
60125	Full Covered	60409	Full Covered	60534	Full Covered	60666	Full Covered	61111	Full Covered	61564	Full Covered
60126	Full Covered	60410	Full Covered	60538	Full Covered	60667	Full Covered	61112	Full Covered	61568	Mostly Covered
60128	Full Covered	60411	Full Covered	60539	Full Covered	60668	Full Covered	61114	Full Covered	61569	Mostly Covered
60129	Full Covered	60412	Full Covered	60540	Full Covered	60670	Full Covered	61115	Full Covered	61571	Mostly Covered
60130	Full Covered	60415	Full Covered	60542	Full Covered	60671	Full Covered	61125	Full Covered	61601	Full Covered
60131	Full Covered	60416	Full Covered	60543	Mostly Covered	60673	Full Covered	61126	Full Covered	61602	Full Covered
60132	Full Covered	60417	Full Covered	60544	Mostly Covered	60674	Full Covered	61130	Full Covered	61603	Full Covered
60133	Full Covered	60419	Full Covered	60546	Full Covered	60675	Full Covered	61131	Full Covered	61604	Full Covered
60134	Full Covered	60421	Mostly Covered	60550	Full Covered	60677	Full Covered	61132	Full Covered	61605	Full Covered
60135	Mostly Covered	60422	Full Covered	60553	Mostly Covered	60678	Full Covered	61201	Full Covered	61606	Full Covered
60136	Full Covered	60423	Full Covered	60555	Full Covered	60679	Full Covered	61204	Full Covered	61607	Full Covered
60137	Full Covered	60425	Full Covered	60556	Mostly Covered	60680	Full Covered	61230	Full Covered	61610	Full Covered
60138	Full Covered	60426	Full Covered	60558	Full Covered	60681	Full Covered	61232	Mostly Covered	61611	Full Covered
60139	Full Covered	60429	Full Covered	60559	Full Covered	60682	Full Covered	61234	Mostly Covered	61612	Mostly Covered
60140	Full Covered	60430	Full Covered	60561	Full Covered	60683	Full Covered	61235	Mostly Covered	61613	Mostly Covered
60141	Full Covered	60431	Mostly Covered	60563	Full Covered	60684	Full Covered	61236	Full Covered	61614	Mostly Covered
60142	Mostly Covered	60432	Full Covered	60564	Full Covered	60685	Full Covered	61239	Full Covered	61615	Full Covered
60143	Full Covered	60433	Full Covered	60565	Full Covered	60686	Full Covered	61240	Mostly Covered	61616	Mostly Covered
60145	Mostly Covered	60434	Full Covered	60566	Full Covered	60687	Full Covered	61241	Full Covered	61625	Full Covered
60146	Mostly Covered	60435	Full Covered	60567	Full Covered	60688	Full Covered	61242	Mostly Covered	61628	Full Covered
60147	Mostly Covered	60436	Full Covered	60568	Full Covered	60689	Full Covered	61243	Mostly Covered	61629	Full Covered
60148	Full Covered	60438	Full Covered	60570	Full Covered	60690	Full Covered	61244	Full Covered	61630	Full Covered
60150	Full Covered	60439	Full Covered	60572	Full Covered	60691	Full Covered	61252	Full Covered	61632	Mostly Covered
60151	Mostly Covered	60440	Full Covered	60597	Full Covered	60693	Full Covered	61256	Full Covered	61633	Full Covered
60152	Full Covered	60441	Full Covered	60598	Full Covered	60694	Full Covered	61257	Mostly Covered	61634	Full Covered
60153	Full Covered	60442	Mostly Covered	60599	Full Covered	60695	Full Covered	61259	Full Covered	61635	Full Covered
60154	Full Covered	60443	Mostly Covered	60601	Full Covered	60696	Full Covered	61261	Mostly Covered	61636	Full Covered
60155	Full Covered	60445	Full Covered	60602	Full Covered	60697	Full Covered	61264	Mostly Covered	61637	Full Covered
60156	Full Covered	60446	Full Covered	60603	Full Covered	60701	Full Covered	61265	Full Covered	61638	Mostly Covered
60157	Full Covered	60447	Full Covered	60604	Full Covered	60706	Full Covered	61266	Full Covered	61639	Full Covered
60159	Full Covered	60448	Full Covered	60605	Full Covered	60707	Full Covered	61273	Mostly Covered	61640	Mostly Covered
60160	Full Covered	60449	Mostly Covered	60606	Full Covered	60712	Full Covered	61275	Full Covered	61641	Full Covered
60161	Full Covered	60450	Mostly Covered	60607	Full Covered	60714	Full Covered	61278	Full Covered	61643	Full Covered
60162	Full Covered	60451	Full Covered	60608	Full Covered	60803	Full Covered	61282	Full Covered	61644	Mostly Covered
60163	Full Covered	60452	Full Covered	60609	Full Covered	60804	Full Covered	61283	Mostly Covered	61650	Full Covered
60164	Full Covered	60453	Full Covered	60610	Full Covered	60805	Full Covered	61284	Mostly Covered	61651	Full Covered
60165	Full Covered	60454	Full Covered	60611	Full Covered	60827	Full Covered	61299	Full Covered	61652	Full Covered
60168	Full Covered	60455	Full Covered	60612	Full Covered	60901	Full Covered	61301	Mostly Covered	61653	Full Covered
60170	Full Covered	60456	Full Covered	60613	Full Covered	60902	Full Covered	61311	Mostly Covered	61654	Full Covered
60171	Full Covered	60457	Full Covered	60614	Full Covered	60910	Full Covered	61315	Mostly Covered	61655	Full Covered
60172	Full Covered	60458	Full Covered	60615	Full Covered	60914	Full Covered	61316	Mostly Covered	61656	Full Covered
60173	Full Covered	60459	Full Covered	60616	Full Covered	60915	Full Covered	61319	Full Covered	61701	Full Covered
60174	Full Covered	60461	Full Covered	60617	Full Covered	60922	Mostly Covered	61323	Mostly Covered	61702	Full Covered
60175	Full Covered	60462	Full Covered	60618	Full Covered	60940	Mostly Covered	61325	Mostly Covered	61704	Full Covered
60176	Full Covered	60463	Full Covered	60619	Full Covered	60950	Full Covered	61328	Mostly Covered	61709	Full Covered
60177	Full Covered	60464	Full Covered	60620	Full Covered	61007	Mostly Covered	61332	Full Covered	61710	Full Covered
60178	Full Covered	60465	Full Covered	60621	Full Covered	61008	Mostly Covered	61333	Mostly Covered	61725	Mostly Covered
60179	Full Covered	60466	Full Covered	60622	Full Covered	61011	Full Covered	61338	Mostly Covered	61726	Mostly Covered
60180	Full Covered	60467	Full Covered	60623	Full Covered	61013	Full Covered	61344	Mostly Covered	61736	Mostly Covered
60181	Full Covered	60468	Mostly Covered	60624	Full Covered	61016	Full Covered	61345	Full Covered	61740	Mostly Covered

Zip Code	Coverage Level	Zip Code	Coverage Level	Zip Code	Coverage Level	Zip Code	Coverage Level	Zip Code	Coverage Level	Zip Code	Coverage Level
61743	Full Covered	62225	Mostly Covered	62702	Full Covered	62864	Full Covered	62995	Mostly Covered	63139	Full Covered
61745	Full Covered	62226	Full Covered	62703	Full Covered	62865	Mostly Covered	62996	Full Covered	63140	Full Covered
61748	Mostly Covered	62232	Full Covered	62704	Full Covered	62868	Mostly Covered	62997	Mostly Covered	63141	Full Covered
61750	Mostly Covered	62233	Mostly Covered	62705	Full Covered	62869	Full Covered	62999	Mostly Covered	63143	Full Covered
61756	Mostly Covered	62234	Full Covered	62706	Full Covered	62871	Mostly Covered	63001	Full Covered	63144	Full Covered
61758	Mostly Covered	62236	Full Covered	62707	Full Covered	62872	Full Covered	63005	Full Covered	63145	Full Covered
61761	Full Covered	62237	Mostly Covered	62708	Full Covered	62874	Full Covered	63006	Full Covered	63146	Full Covered
61764	Full Covered	62238	Mostly Covered	62713	Full Covered	62876	Mostly Covered	63010	Full Covered	63147	Full Covered
61772	Full Covered	62239	Full Covered	62715	Full Covered	62877	Mostly Covered	63011	Full Covered	63150	Full Covered
61776	Mostly Covered	62240	Full Covered	62716	Full Covered	62878	Full Covered	63012	Full Covered	63151	Full Covered
61790	Full Covered	62243	Mostly Covered	62719	Full Covered	62879	Mostly Covered	63015	Mostly Covered	63155	Full Covered
61791	Full Covered	62244	Mostly Covered	62721	Full Covered	62886	Mostly Covered	63016	Mostly Covered	63156	Full Covered
61799	Full Covered	62256	Mostly Covered	62722	Full Covered	62887	Mostly Covered	63017	Full Covered	63157	Full Covered
61801	Full Covered	62260	Full Covered	62723	Full Covered	62888	Full Covered	63019	Full Covered	63158	Full Covered
61802	Mostly Covered	62263	Full Covered	62726	Full Covered	62889	Mostly Covered	63021	Full Covered	63160	Full Covered
61803	Full Covered	62269	Full Covered	62736	Full Covered	62890	Mostly Covered	63022	Full Covered	63163	Full Covered
61811	Mostly Covered	62272	Full Covered	62739	Full Covered	62891	Mostly Covered	63024	Full Covered	63164	Full Covered
61814	Mostly Covered	62274	Mostly Covered	62746	Full Covered	62893	Mostly Covered	63025	Full Covered	63166	Full Covered
61815	Full Covered	62281	Mostly Covered	62756	Full Covered	62894	Mostly Covered	63026	Full Covered	63167	Full Covered
61817	Full Covered	62285	Full Covered	62757	Full Covered	62895	Mostly Covered	63028	Full Covered	63169	Full Covered
61818	Mostly Covered	62286	Full Covered	62761	Full Covered	62896	Full Covered	63031	Full Covered	63171	Full Covered
61820	Full Covered	62288	Full Covered	62762	Full Covered	62897	Mostly Covered	63032	Full Covered	63177	Full Covered
61821	Full Covered	62292	Mostly Covered	62763	Full Covered	62898	Mostly Covered	63033	Full Covered	63178	Full Covered
61822	Full Covered	62294	Full Covered	62764	Full Covered	62899	Mostly Covered	63034	Full Covered	63179	Full Covered
61824	Full Covered	62295	Full Covered	62765	Full Covered	62901	Full Covered	63038	Full Covered	63180	Full Covered
61825	Full Covered	62297	Mostly Covered	62766	Full Covered	62902	Full Covered	63040	Full Covered	63182	Full Covered
61826	Full Covered	62301	Full Covered	62767	Full Covered	62903	Full Covered	63042	Full Covered	63188	Full Covered
61830	Full Covered	62305	Full Covered	62769	Full Covered	62905	Mostly Covered	63043	Full Covered	63190	Full Covered
61831	Full Covered	62306	Full Covered	62776	Full Covered	62906	Full Covered	63044	Full Covered	63195	Full Covered
61832	Full Covered	62338	Full Covered	62777	Full Covered	62908	Mostly Covered	63045	Full Covered	63196	Full Covered
61833	Full Covered	62354	Full Covered	62781	Full Covered	62909	Mostly Covered	63047	Full Covered	63197	Full Covered
61834	Full Covered	62358	Full Covered	62786	Full Covered	62910	Mostly Covered	63048	Full Covered	63198	Full Covered
61840	Mostly Covered	62359	Mostly Covered	62791	Full Covered	62912	Full Covered	63049	Full Covered	63199	Full Covered
61841	Mostly Covered	62360	Mostly Covered	62794	Full Covered	62914	Mostly Covered	63050	Mostly Covered	63301	Full Covered
61843	Mostly Covered	62410	Mostly Covered	62796	Full Covered	62915	Full Covered	63051	Full Covered	63302	Full Covered
61844	Mostly Covered	62417	Mostly Covered	62803	Full Covered	62917	Full Covered	63052	Full Covered	63303	Full Covered
61848	Mostly Covered	62419	Full Covered	62805	Mostly Covered	62918	Mostly Covered	63053	Full Covered	63304	Full Covered
61853	Mostly Covered	62421	Mostly Covered	62806	Mostly Covered	62920	Full Covered	63057	Full Covered	63332	Mostly Covered
61855	Mostly Covered	62423	Mostly Covered	62808	Mostly Covered	62921	Full Covered	63065	Mostly Covered	63338	Full Covered
61857	Mostly Covered	62425	Mostly Covered	62809	Full Covered	62922	Mostly Covered	63066	Mostly Covered	63341	Full Covered
61858	Full Covered	62427	Mostly Covered	62810	Full Covered	62924	Full Covered	63069	Full Covered	63342	Mostly Covered
61874	Mostly Covered	62439	Full Covered	62811	Full Covered	62926	Mostly Covered	63070	Full Covered	63346	Full Covered
61875	Mostly Covered	62450	Full Covered	62812	Full Covered	62927	Full Covered	63073	Mostly Covered	63348	Full Covered
61878	Mostly Covered	62452	Full Covered	62814	Mostly Covered	62928	Mostly Covered	63074	Full Covered	63365	Full Covered
61882	Mostly Covered	62460	Full Covered	62816	Mostly Covered	62930	Mostly Covered	63088	Full Covered	63366	Full Covered
61883	Mostly Covered	62466	Mostly Covered	62817	Mostly Covered	62932	Full Covered	63099	Full Covered	63367	Full Covered
61936	Mostly Covered	62476	Mostly Covered	62818	Mostly Covered	62933	Full Covered	63101	Full Covered	63369	Mostly Covered
61955	Mostly Covered	62501	Full Covered	62819	Full Covered	62935	Mostly Covered	63102	Full Covered	63373	Mostly Covered
62002	Mostly Covered	62514	Full Covered	62820	Full Covered	62939	Full Covered	63103	Full Covered	63376	Full Covered
62012	Mostly Covered	62520	Mostly Covered	62821	Full Covered	62940	Mostly Covered	63104	Full Covered	63385	Full Covered
62018	Mostly Covered	62521	Full Covered	62822	Mostly Covered	62943	Full Covered	63105	Full Covered	63386	Full Covered
62022	Full Covered	62522	Full Covered	62823	Full Covered	62946	Full Covered	63106	Full Covered	63390	Mostly Covered
62024	Mostly Covered	62523	Full Covered	62824	Mostly Covered	62947	Full Covered	63107	Full Covered	63701	Full Covered
62025	Full Covered	62524	Full Covered	62825	Mostly Covered	62948	Full Covered	63108	Full Covered	63702	Full Covered
62026	Full Covered	62525	Full Covered	62827	Full Covered	62949	Mostly Covered	63109	Full Covered	63703	Full Covered
62028	Full Covered	62526	Full Covered	62828	Mostly Covered	62951	Full Covered	63110	Full Covered	63705	Full Covered
62034	Full Covered	62532	Full Covered	62829	Full Covered	62952	Full Covered	63111	Full Covered	63745	Mostly Covered
62035	Full Covered	62535	Full Covered	62830	Full Covered	62953	Full Covered	63112	Full Covered	63752	Full Covered
62036	Full Covered	62536	Mostly Covered	62831	Mostly Covered	62955	Mostly Covered	63113	Full Covered	63755	Full Covered
62040	Mostly Covered	62537	Full Covered	62832	Full Covered	62956	Mostly Covered	63114	Full Covered	63779	Mostly Covered
62048	Mostly Covered	62543	Mostly Covered	62833	Mostly Covered	62957	Mostly Covered	63115	Full Covered	64011	Full Covered
62052	Mostly Covered	62544	Mostly Covered	62834	Mostly Covered	62958	Mostly Covered	63116	Full Covered	64012	Mostly Covered
62059	Full Covered	62549	Mostly Covered	62835	Full Covered	62959	Full Covered	63117	Full Covered	64013	Full Covered
62060	Full Covered	62551	Mostly Covered	62836	Mostly Covered	62960	Mostly Covered	63118	Full Covered	64014	Mostly Covered
62061	Mostly Covered	62554	Full Covered	62837	Full Covered	62961	Full Covered	63119	Full Covered	64015	Full Covered
62062	Full Covered	62555	Full Covered	62839	Full Covered	62963	Full Covered	63120	Full Covered	64016	Mostly Covered
62071	Full Covered	62556	Mostly Covered	62840	Full Covered	62964	Full Covered	63121	Full Covered	64018	Mostly Covered
62083	Mostly Covered	62557	Mostly Covered	62841	Full Covered	62965	Full Covered	63122	Full Covered	64028	Full Covered
62084	Mostly Covered	62561	Full Covered	62842	Full Covered	62966	Full Covered	63123	Full Covered	64029	Full Covered
62087	Mostly Covered	62563	Full Covered	62843	Mostly Covered	62970	Full Covered	63124	Full Covered	64030	Full Covered
62090	Full Covered	62567	Mostly Covered	62844	Full Covered	62971	Mostly Covered	63125	Full Covered	64034	Mostly Covered
62095	Mostly Covered	62568	Full Covered	62845	Full Covered	62973	Mostly Covered	63126	Full Covered	64048	Mostly Covered
62201	Full Covered	62573	Full Covered	62850	Mostly Covered	62974	Mostly Covered	63127	Full Covered	64050	Full Covered
62202	Full Covered	62601	Mostly Covered	62851	Full Covered	62975	Mostly Covered	63128	Full Covered	64051	Full Covered
62203	Full Covered	62625	Mostly Covered	62852	Full Covered	62976	Full Covered	63129	Full Covered	64052	Full Covered
62204	Full Covered	62629	Mostly Covered	62853	Mostly Covered	62977	Mostly Covered	63130	Full Covered	64053	Full Covered
62205	Full Covered	62638	Mostly Covered	62855	Mostly Covered	62982	Mostly Covered	63131	Full Covered	64054	Full Covered
62206	Full Covered	62650	Full Covered	62856	Full Covered	62983	Mostly Covered	63132	Full Covered	64055	Full Covered
62207	Full Covered	62651	Full Covered	62858	Full Covered	62985	Mostly Covered	63133	Full Covered	64056	Full Covered
62208	Full Covered	62660	Mostly Covered	62859	Full Covered	62987	Mostly Covered	63134	Full Covered	64057	Full Covered
62220	Full Covered	62668	Mostly Covered	62860	Full Covered	62988	Mostly Covered	63135	Full Covered	64058	Mostly Covered
62221	Mostly Covered	62684	Mostly Covered	62861	Full Covered	62992	Full Covered	63136	Full Covered	64060	Full Covered
62222	Full Covered	62695	Full Covered	62862	Full Covered	62993	Full Covered	63137	Full Covered	64061	Mostly Covered
62223	Full Covered	62701	Full Covered	62863	Full Covered	62994	Full Covered	63138	Full Covered	64063	Full Covered

Zip Code	Coverage Level	Zip Code	Coverage Level	Zip Code	Coverage Level	Zip Code	Coverage Level	Zip Code	Coverage Level	Zip Code	Coverage Level
64064	Full Covered	64185	Full Covered	65630	Mostly Covered	66206	Full Covered	67001	Mostly Covered	68034	Full Covered
64065	Full Covered	64187	Full Covered	65631	Mostly Covered	66207	Full Covered	67002	Full Covered	68037	Full Covered
64066	Mostly Covered	64188	Full Covered	65648	Mostly Covered	66208	Full Covered	67016	Full Covered	68044	Mostly Covered
64068	Full Covered	64190	Full Covered	65653	Full Covered	66209	Full Covered	67017	Full Covered	68046	Mostly Covered
64069	Full Covered	64191	Full Covered	65672	Mostly Covered	66210	Full Covered	67026	Mostly Covered	68056	Full Covered
64070	Full Covered	64192	Full Covered	65679	Mostly Covered	66211	Full Covered	67030	Full Covered	68058	Full Covered
64072	Mostly Covered	64193	Full Covered	65680	Mostly Covered	66212	Full Covered	67037	Mostly Covered	68059	Full Covered
64073	Mostly Covered	64194	Full Covered	65714	Full Covered	66213	Full Covered	67042	Mostly Covered	68068	Mostly Covered
64074	Mostly Covered	64195	Full Covered	65726	Mostly Covered	66214	Full Covered	67052	Mostly Covered	68101	Full Covered
64075	Full Covered	64196	Full Covered	65731	Full Covered	66215	Full Covered	67053	Mostly Covered	68102	Full Covered
64076	Mostly Covered	64197	Full Covered	65738	Mostly Covered	66216	Full Covered	67055	Full Covered	68103	Full Covered
64078	Full Covered	64198	Full Covered	65740	Full Covered	66217	Full Covered	67056	Mostly Covered	68104	Full Covered
64079	Full Covered	64199	Full Covered	65754	Mostly Covered	66218	Full Covered	67060	Full Covered	68105	Full Covered
64081	Full Covered	64421	Mostly Covered	65759	Mostly Covered	66219	Full Covered	67062	Full Covered	68106	Full Covered
64082	Full Covered	64436	Full Covered	65765	Mostly Covered	66220	Full Covered	67067	Full Covered	68107	Full Covered
64083	Full Covered	64459	Mostly Covered	65771	Full Covered	66221	Full Covered	67101	Full Covered	68108	Full Covered
64086	Mostly Covered	64485	Full Covered	65781	Mostly Covered	66222	Full Covered	67108	Mostly Covered	68109	Full Covered
64087	Full Covered	64492	Mostly Covered	65801	Full Covered	66223	Full Covered	67114	Full Covered	68110	Full Covered
64089	Full Covered	64501	Full Covered	65802	Full Covered	66224	Full Covered	67117	Full Covered	68111	Full Covered
64092	Full Covered	64502	Full Covered	65803	Full Covered	66225	Full Covered	67120	Mostly Covered	68112	Mostly Covered
64098	Mostly Covered	64503	Full Covered	65804	Full Covered	66226	Full Covered	67123	Mostly Covered	68113	Mostly Covered
64101	Full Covered	64505	Full Covered	65805	Full Covered	66227	Full Covered	67133	Mostly Covered	68114	Full Covered
64102	Full Covered	64506	Full Covered	65806	Full Covered	66250	Full Covered	67135	Mostly Covered	68116	Full Covered
64105	Full Covered	64507	Mostly Covered	65807	Full Covered	66251	Full Covered	67144	Full Covered	68117	Full Covered
64106	Full Covered	64508	Full Covered	65808	Full Covered	66276	Full Covered	67147	Full Covered	68118	Full Covered
64108	Full Covered	64701	Mostly Covered	65809	Full Covered	66282	Full Covered	67151	Mostly Covered	68119	Full Covered
64109	Full Covered	64734	Mostly Covered	65810	Full Covered	66283	Full Covered	67201	Full Covered	68120	Full Covered
64110	Full Covered	64746	Mostly Covered	65814	Full Covered	66285	Full Covered	67202	Full Covered	68122	Mostly Covered
64111	Full Covered	64801	Full Covered	65817	Full Covered	66286	Full Covered	67203	Full Covered	68123	Mostly Covered
64112	Full Covered	64802	Full Covered	65890	Full Covered	66402	Full Covered	67204	Full Covered	68124	Full Covered
64113	Full Covered	64803	Full Covered	65898	Full Covered	66409	Mostly Covered	67205	Full Covered	68127	Full Covered
64114	Full Covered	64804	Full Covered	65899	Full Covered	66420	Full Covered	67206	Full Covered	68128	Full Covered
64116	Full Covered	64834	Mostly Covered	66006	Mostly Covered	66429	Full Covered	67207	Full Covered	68130	Full Covered
64117	Full Covered	64835	Mostly Covered	66007	Mostly Covered	66431	Mostly Covered	67208	Full Covered	68131	Full Covered
64118	Full Covered	64841	Mostly Covered	66012	Mostly Covered	66502	Full Covered	67209	Full Covered	68132	Full Covered
64119	Full Covered	64858	Mostly Covered	66013	Mostly Covered	66503	Full Covered	67210	Full Covered	68133	Mostly Covered
64120	Full Covered	64864	Full Covered	66018	Mostly Covered	66505	Full Covered	67211	Full Covered	68134	Full Covered
64121	Full Covered	64865	Mostly Covered	66019	Mostly Covered	66506	Full Covered	67212	Full Covered	68135	Full Covered
64123	Full Covered	64870	Mostly Covered	66020	Mostly Covered	66507	Mostly Covered	67213	Full Covered	68136	Full Covered
64124	Full Covered	64999	Full Covered	66021	Mostly Covered	66517	Mostly Covered	67214	Full Covered	68137	Full Covered
64125	Full Covered	65017	Mostly Covered	66024	Full Covered	66535	Mostly Covered	67215	Full Covered	68138	Full Covered
64126	Full Covered	65043	Full Covered	66025	Mostly Covered	66542	Full Covered	67216	Full Covered	68139	Full Covered
64127	Full Covered	65047	Full Covered	66027	Full Covered	66546	Mostly Covered	67217	Full Covered	68142	Full Covered
64128	Full Covered	65049	Full Covered	66030	Full Covered	66601	Full Covered	67218	Full Covered	68144	Full Covered
64129	Full Covered	65052	Full Covered	66031	Full Covered	66603	Full Covered	67219	Full Covered	68145	Full Covered
64130	Full Covered	65065	Full Covered	66036	Full Covered	66604	Full Covered	67220	Full Covered	68147	Full Covered
64131	Full Covered	65072	Mostly Covered	66043	Full Covered	66605	Full Covered	67221	Full Covered	68152	Full Covered
64132	Full Covered	65076	Mostly Covered	66044	Full Covered	66606	Full Covered	67223	Full Covered	68154	Full Covered
64133	Full Covered	65079	Mostly Covered	66045	Full Covered	66607	Full Covered	67226	Full Covered	68155	Full Covered
64134	Full Covered	65082	Mostly Covered	66046	Full Covered	66608	Full Covered	67227	Mostly Covered	68157	Full Covered
64136	Full Covered	65083	Mostly Covered	66047	Full Covered	66609	Full Covered	67228	Full Covered	68164	Full Covered
64137	Full Covered	65085	Mostly Covered	66048	Full Covered	66610	Full Covered	67230	Full Covered	68172	Full Covered
64138	Full Covered	65101	Full Covered	66049	Full Covered	66611	Full Covered	67232	Full Covered	68175	Full Covered
64139	Full Covered	65102	Full Covered	66050	Full Covered	66612	Full Covered	67235	Full Covered	68176	Full Covered
64141	Full Covered	65103	Full Covered	66051	Full Covered	66614	Full Covered	67260	Full Covered	68178	Full Covered
64144	Full Covered	65104	Full Covered	66061	Full Covered	66615	Full Covered	67275	Full Covered	68179	Full Covered
64145	Full Covered	65105	Full Covered	66062	Mostly Covered	66616	Full Covered	67276	Full Covered	68180	Full Covered
64146	Full Covered	65106	Full Covered	66063	Full Covered	66617	Full Covered	67277	Full Covered	68181	Full Covered
64147	Full Covered	65107	Full Covered	66070	Mostly Covered	66618	Full Covered	67278	Full Covered	68182	Full Covered
64148	Full Covered	65108	Full Covered	66071	Mostly Covered	66619	Full Covered	67401	Full Covered	68183	Full Covered
64149	Full Covered	65109	Full Covered	66073	Full Covered	66620	Full Covered	67402	Full Covered	68197	Full Covered
64150	Full Covered	65110	Full Covered	66083	Full Covered	66621	Full Covered	67422	Full Covered	68198	Full Covered
64151	Full Covered	65111	Full Covered	66085	Full Covered	66622	Full Covered	67470	Full Covered	68304	Full Covered
64152	Full Covered	65201	Full Covered	66101	Full Covered	66624	Full Covered	67501	Mostly Covered	68336	Mostly Covered
64153	Full Covered	65202	Full Covered	66102	Full Covered	66625	Full Covered	67502	Full Covered	68339	Mostly Covered
64154	Full Covered	65203	Full Covered	66103	Full Covered	66626	Full Covered	67504	Full Covered	68347	Full Covered
64155	Full Covered	65205	Full Covered	66104	Full Covered	66628	Full Covered	67505	Mostly Covered	68366	Mostly Covered
64156	Full Covered	65211	Full Covered	66105	Full Covered	66629	Full Covered	67522	Mostly Covered	68403	Mostly Covered
64157	Full Covered	65212	Full Covered	66106	Full Covered	66636	Full Covered	67546	Full Covered	68407	Mostly Covered
64158	Full Covered	65215	Full Covered	66109	Full Covered	66637	Full Covered	67846	Full Covered	68430	Mostly Covered
64160	Full Covered	65216	Full Covered	66110	Full Covered	66647	Full Covered	68005	Full Covered	68438	Mostly Covered
64161	Full Covered	65217	Full Covered	66111	Full Covered	66652	Full Covered	68007	Mostly Covered	68461	Full Covered
64163	Full Covered	65218	Full Covered	66112	Full Covered	66653	Full Covered	68008	Full Covered	68462	Full Covered
64164	Full Covered	65231	Mostly Covered	66113	Full Covered	66667	Full Covered	68009	Full Covered	68463	Mostly Covered
64165	Full Covered	65232	Mostly Covered	66115	Full Covered	66675	Full Covered	68010	Full Covered	68501	Full Covered
64166	Full Covered	65240	Full Covered	66117	Full Covered	66683	Full Covered	68015	Full Covered	68502	Full Covered
64167	Full Covered	65255	Full Covered	66118	Full Covered	66686	Full Covered	68016	Full Covered	68503	Full Covered
64168	Full Covered	65265	Full Covered	66119	Full Covered	66692	Full Covered	68018	Mostly Covered	68504	Full Covered
64170	Full Covered	65284	Mostly Covered	66160	Full Covered	66699	Full Covered	68022	Mostly Covered	68505	Full Covered
64171	Full Covered	65285	Mostly Covered	66201	Full Covered	66739	Mostly Covered	68023	Mostly Covered	68506	Full Covered
64172	Full Covered	65299	Mostly Covered	66202	Full Covered	66770	Mostly Covered	68025	Mostly Covered	68507	Full Covered
64179	Full Covered	65615	Full Covered	66203	Full Covered	66801	Full Covered	68026	Mostly Covered	68508	Full Covered
64180	Full Covered	65616	Full Covered	66204	Full Covered	66864	Mostly Covered	68028	Full Covered	68509	Full Covered
64184	Full Covered	65619	Full Covered	66205	Full Covered	66868	Mostly Covered	68030	Mostly Covered	68510	Full Covered

Zip Code	Coverage Level	Zip Code	Coverage Level	Zip Code	Coverage Level	Zip Code	Coverage Level	Zip Code	Coverage Level	Zip Code	Coverage Level
68512	Full Covered	70094	Full Covered	70393	Full Covered	70602	Mostly Covered	70874	Full Covered	71303	Mostly Covered
68514	Mostly Covered	70096	Full Covered	70394	Full Covered	70605	Full Covered	70879	Full Covered	71306	Full Covered
68516	Full Covered	70112	Full Covered	70395	Full Covered	70606	Full Covered	70883	Full Covered	71307	Full Covered
68517	Full Covered	70113	Full Covered	70401	Full Covered	70609	Mostly Covered	70884	Full Covered	71309	Full Covered
68520	Full Covered	70114	Full Covered	70402	Full Covered	70611	Mostly Covered	70892	Full Covered	71315	Full Covered
68521	Full Covered	70115	Full Covered	70403	Full Covered	70612	Mostly Covered	70893	Full Covered	71346	Mostly Covered
68522	Full Covered	70116	Full Covered	70404	Full Covered	70615	Full Covered	70894	Full Covered	71348	Full Covered
68523	Full Covered	70117	Full Covered	70420	Full Covered	70616	Full Covered	70895	Full Covered	71359	Full Covered
68524	Mostly Covered	70118	Full Covered	70421	Full Covered	70629	Mostly Covered	70896	Full Covered	71360	Full Covered
68526	Mostly Covered	70119	Full Covered	70426	Mostly Covered	70630	Mostly Covered	70898	Full Covered	71361	Full Covered
68527	Full Covered	70121	Full Covered	70427	Full Covered	70647	Full Covered	71007	Full Covered	71373	Mostly Covered
68528	Mostly Covered	70122	Full Covered	70429	Full Covered	70659	Mostly Covered	71009	Mostly Covered	71405	Full Covered
68529	Full Covered	70123	Full Covered	70431	Mostly Covered	70663	Full Covered	71023	Mostly Covered	71446	Mostly Covered
68531	Full Covered	70124	Full Covered	70433	Full Covered	70664	Full Covered	71033	Full Covered	71459	Full Covered
68532	Mostly Covered	70125	Full Covered	70434	Full Covered	70665	Mostly Covered	71037	Full Covered	71461	Full Covered
68542	Full Covered	70126	Full Covered	70435	Mostly Covered	70669	Full Covered	71047	Mostly Covered	71477	Full Covered
68583	Full Covered	70127	Full Covered	70443	Mostly Covered	70704	Full Covered	71067	Full Covered	71496	Full Covered
68588	Full Covered	70128	Full Covered	70445	Mostly Covered	70707	Full Covered	71101	Full Covered	71601	Full Covered
68621	Full Covered	70129	Mostly Covered	70447	Mostly Covered	70710	Mostly Covered	71102	Full Covered	71602	Full Covered
68649	Mostly Covered	70130	Full Covered	70448	Full Covered	70711	Full Covered	71103	Full Covered	71603	Full Covered
68701	Full Covered	70131	Full Covered	70451	Full Covered	70714	Full Covered	71104	Full Covered	71611	Full Covered
68702	Full Covered	70139	Full Covered	70452	Mostly Covered	70718	Full Covered	71105	Full Covered	71612	Full Covered
68731	Full Covered	70140	Full Covered	70454	Mostly Covered	70719	Mostly Covered	71106	Mostly Covered	71613	Full Covered
68738	Full Covered	70141	Full Covered	70455	Mostly Covered	70721	Mostly Covered	71107	Mostly Covered	71724	Mostly Covered
68740	Mostly Covered	70142	Full Covered	70457	Mostly Covered	70723	Mostly Covered	71108	Full Covered	71730	Full Covered
68743	Mostly Covered	70143	Mostly Covered	70458	Full Covered	70725	Full Covered	71109	Full Covered	71731	Full Covered
68776	Full Covered	70145	Full Covered	70459	Full Covered	70726	Full Covered	71110	Full Covered	71751	Mostly Covered
68801	Mostly Covered	70146	Full Covered	70460	Full Covered	70727	Full Covered	71111	Full Covered	71759	Full Covered
68802	Mostly Covered	70148	Full Covered	70461	Full Covered	70728	Full Covered	71112	Mostly Covered	71762	Full Covered
68803	Mostly Covered	70149	Full Covered	70462	Mostly Covered	70729	Full Covered	71113	Full Covered	71801	Full Covered
68810	Full Covered	70150	Full Covered	70463	Full Covered	70733	Full Covered	71118	Mostly Covered	71802	Full Covered
68832	Full Covered	70151	Full Covered	70466	Full Covered	70734	Mostly Covered	71119	Full Covered	71835	Mostly Covered
69341	Mostly Covered	70152	Full Covered	70469	Full Covered	70736	Full Covered	71120	Full Covered	71837	Mostly Covered
69353	Full Covered	70153	Full Covered	70470	Full Covered	70737	Full Covered	71129	Full Covered	71839	Mostly Covered
69355	Full Covered	70154	Full Covered	70471	Full Covered	70738	Full Covered	71130	Full Covered	71840	Full Covered
69357	Mostly Covered	70156	Full Covered	70501	Full Covered	70739	Full Covered	71133	Full Covered	71854	Full Covered
69361	Full Covered	70157	Full Covered	70502	Full Covered	70743	Mostly Covered	71134	Full Covered	71901	Full Covered
69363	Full Covered	70158	Full Covered	70503	Full Covered	70744	Mostly Covered	71135	Full Covered	71902	Full Covered
70001	Full Covered	70159	Full Covered	70504	Full Covered	70749	Mostly Covered	71136	Full Covered	71903	Full Covered
70002	Full Covered	70160	Full Covered	70505	Full Covered	70754	Mostly Covered	71137	Full Covered	71909	Mostly Covered
70003	Full Covered	70161	Full Covered	70506	Full Covered	70763	Mostly Covered	71138	Full Covered	71910	Mostly Covered
70004	Full Covered	70162	Full Covered	70507	Full Covered	70765	Mostly Covered	71148	Full Covered	71913	Full Covered
70005	Full Covered	70163	Full Covered	70508	Full Covered	70767	Mostly Covered	71149	Full Covered	71914	Full Covered
70006	Full Covered	70164	Full Covered	70509	Full Covered	70769	Full Covered	71151	Full Covered	71929	Full Covered
70009	Full Covered	70165	Full Covered	70511	Mostly Covered	70773	Mostly Covered	71152	Full Covered	71956	Mostly Covered
70010	Full Covered	70166	Full Covered	70512	Full Covered	70774	Mostly Covered	71153	Full Covered	71964	Mostly Covered
70011	Full Covered	70167	Full Covered	70513	Mostly Covered	70776	Full Covered	71154	Full Covered	72002	Mostly Covered
70031	Mostly Covered	70170	Full Covered	70514	Full Covered	70778	Mostly Covered	71156	Full Covered	72003	Mostly Covered
70032	Full Covered	70172	Full Covered	70517	Mostly Covered	70780	Full Covered	71161	Full Covered	72015	Full Covered
70033	Full Covered	70174	Full Covered	70518	Mostly Covered	70786	Mostly Covered	71162	Full Covered	72016	Mostly Covered
70039	Mostly Covered	70175	Full Covered	70519	Full Covered	70788	Mostly Covered	71163	Full Covered	72018	Full Covered
70043	Full Covered	70176	Full Covered	70520	Full Covered	70791	Full Covered	71164	Full Covered	72022	Mostly Covered
70044	Full Covered	70177	Full Covered	70521	Mostly Covered	70792	Mostly Covered	71165	Full Covered	72023	Mostly Covered
70047	Full Covered	70178	Full Covered	70522	Full Covered	70801	Full Covered	71166	Full Covered	72032	Full Covered
70049	Full Covered	70179	Full Covered	70523	Mostly Covered	70802	Full Covered	71171	Full Covered	72033	Full Covered
70051	Full Covered	70181	Full Covered	70526	Full Covered	70803	Full Covered	71172	Full Covered	72034	Full Covered
70052	Full Covered	70182	Full Covered	70527	Full Covered	70804	Full Covered	71201	Full Covered	72035	Full Covered
70053	Full Covered	70183	Full Covered	70529	Full Covered	70805	Full Covered	71202	Mostly Covered	72047	Mostly Covered
70054	Full Covered	70184	Full Covered	70531	Mostly Covered	70806	Full Covered	71207	Full Covered	72052	Full Covered
70055	Full Covered	70185	Full Covered	70534	Full Covered	70807	Full Covered	71208	Full Covered	72053	Full Covered
70056	Full Covered	70186	Full Covered	70538	Mostly Covered	70808	Full Covered	71209	Mostly Covered	72058	Mostly Covered
70057	Full Covered	70187	Full Covered	70540	Full Covered	70809	Full Covered	71210	Full Covered	72063	Mostly Covered
70058	Full Covered	70189	Full Covered	70541	Full Covered	70810	Full Covered	71211	Mostly Covered	72068	Full Covered
70059	Full Covered	70190	Full Covered	70544	Mostly Covered	70811	Full Covered	71212	Mostly Covered	72070	Full Covered
70060	Full Covered	70195	Full Covered	70550	Full Covered	70812	Full Covered	71213	Mostly Covered	72073	Mostly Covered
70062	Full Covered	70301	Full Covered	70551	Full Covered	70813	Full Covered	71220	Full Covered	72076	Full Covered
70063	Full Covered	70302	Full Covered	70552	Mostly Covered	70814	Full Covered	71221	Full Covered	72078	Full Covered
70064	Full Covered	70310	Full Covered	70555	Full Covered	70815	Full Covered	71225	Mostly Covered	72079	Full Covered
70065	Full Covered	70341	Full Covered	70558	Full Covered	70816	Full Covered	71229	Mostly Covered	72081	Mostly Covered
70068	Full Covered	70343	Mostly Covered	70559	Mostly Covered	70817	Full Covered	71233	Full Covered	72082	Full Covered
70069	Full Covered	70344	Mostly Covered	70560	Mostly Covered	70818	Mostly Covered	71235	Mostly Covered	72085	Mostly Covered
70070	Mostly Covered	70346	Full Covered	70562	Full Covered	70819	Full Covered	71240	Mostly Covered	72089	Mostly Covered
70071	Full Covered	70352	Mostly Covered	70563	Full Covered	70820	Full Covered	71245	Full Covered	72099	Full Covered
70072	Full Covered	70355	Mostly Covered	70569	Full Covered	70821	Full Covered	71270	Full Covered	72102	Full Covered
70073	Full Covered	70359	Mostly Covered	70570	Full Covered	70822	Full Covered	71272	Full Covered	72103	Mostly Covered
70075	Full Covered	70360	Full Covered	70571	Full Covered	70823	Full Covered	71273	Full Covered	72106	Full Covered
70076	Full Covered	70361	Full Covered	70578	Full Covered	70825	Full Covered	71275	Mostly Covered	72107	Mostly Covered
70078	Full Covered	70363	Full Covered	70583	Full Covered	70826	Full Covered	71280	Mostly Covered	72110	Full Covered
70079	Full Covered	70364	Full Covered	70584	Full Covered	70827	Full Covered	71281	Mostly Covered	72113	Full Covered
70080	Mostly Covered	70371	Mostly Covered	70589	Mostly Covered	70831	Full Covered	71291	Full Covered	72114	Full Covered
70084	Full Covered	70372	Full Covered	70592	Full Covered	70833	Full Covered	71292	Full Covered	72115	Full Covered
70087	Full Covered	70375	Full Covered	70596	Full Covered	70835	Full Covered	71294	Full Covered	72116	Full Covered
70090	Full Covered	70390	Mostly Covered	70598	Full Covered	70836	Full Covered	71301	Full Covered	72117	Full Covered
70092	Mostly Covered	70391	Full Covered	70601	Mostly Covered	70837	Full Covered	71302	Full Covered	72118	Full Covered

Zip Code	Coverage Level	Zip Code	Coverage Level	Zip Code	Coverage Level	Zip Code	Coverage Level	Zip Code	Coverage Level	Zip Code	Coverage Level
72119	Full Covered	72737	Full Covered	73102	Full Covered	73503	Full Covered	74120	Full Covered	74901	Mostly Covered
72120	Full Covered	72739	Mostly Covered	73103	Full Covered	73505	Full Covered	74121	Full Covered	74902	Full Covered
72124	Full Covered	72741	Full Covered	73104	Full Covered	73506	Full Covered	74126	Full Covered	74932	Mostly Covered
72125	Mostly Covered	72745	Full Covered	73105	Full Covered	73527	Mostly Covered	74127	Full Covered	74946	Full Covered
72127	Mostly Covered	72751	Mostly Covered	73106	Full Covered	73540	Mostly Covered	74128	Full Covered	74954	Mostly Covered
72132	Full Covered	72753	Mostly Covered	73107	Full Covered	73543	Mostly Covered	74129	Full Covered	75001	Full Covered
72135	Mostly Covered	72756	Mostly Covered	73108	Full Covered	73557	Mostly Covered	74130	Full Covered	75002	Full Covered
72142	Mostly Covered	72757	Full Covered	73109	Full Covered	73646	Full Covered	74131	Full Covered	75006	Full Covered
72143	Full Covered	72758	Full Covered	73110	Full Covered	73658	Mostly Covered	74132	Full Covered	75007	Full Covered
72145	Full Covered	72762	Full Covered	73111	Full Covered	73701	Full Covered	74133	Full Covered	75009	Mostly Covered
72149	Full Covered	72764	Full Covered	73112	Full Covered	73702	Full Covered	74134	Full Covered	75010	Full Covered
72152	Full Covered	72765	Full Covered	73113	Full Covered	73703	Full Covered	74135	Full Covered	75011	Full Covered
72156	Mostly Covered	72766	Full Covered	73114	Full Covered	73705	Mostly Covered	74136	Full Covered	75013	Full Covered
72160	Mostly Covered	72770	Full Covered	73115	Full Covered	73706	Full Covered	74137	Full Covered	75014	Full Covered
72164	Full Covered	72774	Mostly Covered	73116	Full Covered	73724	Mostly Covered	74141	Full Covered	75015	Full Covered
72167	Full Covered	72801	Mostly Covered	73117	Full Covered	73727	Mostly Covered	74145	Full Covered	75016	Full Covered
72170	Full Covered	72811	Mostly Covered	73118	Full Covered	73734	Full Covered	74146	Full Covered	75017	Full Covered
72173	Mostly Covered	72812	Mostly Covered	73119	Full Covered	73742	Mostly Covered	74147	Full Covered	75019	Full Covered
72178	Mostly Covered	72829	Full Covered	73120	Full Covered	73743	Mostly Covered	74148	Full Covered	75020	Full Covered
72180	Mostly Covered	72834	Full Covered	73121	Full Covered	73750	Full Covered	74149	Full Covered	75021	Mostly Covered
72181	Mostly Covered	72835	Full Covered	73122	Full Covered	73753	Full Covered	74150	Full Covered	75022	Full Covered
72182	Mostly Covered	72845	Mostly Covered	73123	Full Covered	73754	Mostly Covered	74152	Full Covered	75023	Full Covered
72183	Mostly Covered	72847	Mostly Covered	73124	Full Covered	73756	Mostly Covered	74153	Full Covered	75024	Full Covered
72190	Full Covered	72901	Full Covered	73125	Full Covered	73762	Mostly Covered	74155	Full Covered	75025	Full Covered
72198	Full Covered	72902	Full Covered	73126	Full Covered	73772	Mostly Covered	74156	Full Covered	75026	Full Covered
72199	Mostly Covered	72903	Full Covered	73127	Mostly Covered	74003	Mostly Covered	74157	Full Covered	75027	Full Covered
72201	Full Covered	72904	Full Covered	73128	Mostly Covered	74004	Full Covered	74158	Full Covered	75028	Full Covered
72202	Full Covered	72905	Mostly Covered	73129	Full Covered	74005	Full Covered	74159	Full Covered	75029	Full Covered
72203	Full Covered	72906	Full Covered	73130	Full Covered	74006	Full Covered	74169	Full Covered	75030	Full Covered
72204	Full Covered	72908	Full Covered	73131	Full Covered	74008	Mostly Covered	74170	Full Covered	75032	Full Covered
72205	Full Covered	72913	Full Covered	73132	Full Covered	74010	Mostly Covered	74171	Full Covered	75034	Full Covered
72206	Full Covered	72914	Full Covered	73134	Full Covered	74011	Mostly Covered	74172	Full Covered	75035	Full Covered
72207	Full Covered	72916	Full Covered	73135	Full Covered	74012	Full Covered	74182	Full Covered	75037	Full Covered
72209	Full Covered	72917	Full Covered	73136	Full Covered	74013	Mostly Covered	74183	Full Covered	75038	Full Covered
72210	Full Covered	72918	Full Covered	73137	Full Covered	74014	Full Covered	74184	Full Covered	75039	Full Covered
72211	Full Covered	72919	Full Covered	73139	Full Covered	74015	Full Covered	74186	Full Covered	75040	Full Covered
72212	Full Covered	72921	Mostly Covered	73140	Mostly Covered	74017	Full Covered	74187	Full Covered	75041	Full Covered
72214	Full Covered	72923	Full Covered	73141	Full Covered	74018	Full Covered	74189	Full Covered	75042	Full Covered
72215	Full Covered	72932	Mostly Covered	73142	Full Covered	74019	Full Covered	74192	Full Covered	75043	Full Covered
72216	Full Covered	72936	Mostly Covered	73143	Full Covered	74020	Mostly Covered	74193	Full Covered	75044	Full Covered
72217	Full Covered	72937	Full Covered	73144	Full Covered	74028	Mostly Covered	74194	Full Covered	75045	Full Covered
72219	Full Covered	72940	Mostly Covered	73145	Full Covered	74029	Full Covered	74301	Mostly Covered	75046	Full Covered
72221	Full Covered	72945	Mostly Covered	73146	Full Covered	74030	Mostly Covered	74331	Mostly Covered	75047	Full Covered
72222	Full Covered	72952	Mostly Covered	73147	Full Covered	74031	Mostly Covered	74340	Full Covered	75048	Full Covered
72223	Full Covered	72956	Full Covered	73148	Full Covered	74032	Mostly Covered	74342	Mostly Covered	75049	Full Covered
72225	Full Covered	72957	Full Covered	73149	Full Covered	74033	Full Covered	74349	Full Covered	75050	Full Covered
72227	Full Covered	73003	Full Covered	73150	Full Covered	74035	Full Covered	74350	Full Covered	75051	Full Covered
72231	Full Covered	73007	Mostly Covered	73151	Full Covered	74036	Mostly Covered	74363	Mostly Covered	75052	Full Covered
72260	Full Covered	73008	Full Covered	73152	Full Covered	74037	Full Covered	74366	Full Covered	75053	Full Covered
72295	Full Covered	73010	Full Covered	73153	Full Covered	74041	Mostly Covered	74367	Full Covered	75054	Full Covered
72301	Mostly Covered	73013	Full Covered	73154	Full Covered	74046	Mostly Covered	74421	Full Covered	75056	Full Covered
72303	Mostly Covered	73019	Full Covered	73155	Full Covered	74047	Mostly Covered	74425	Mostly Covered	75057	Full Covered
72329	Full Covered	73020	Full Covered	73156	Full Covered	74050	Full Covered	74429	Full Covered	75058	Mostly Covered
72350	Mostly Covered	73022	Full Covered	73157	Full Covered	74051	Mostly Covered	74430	Mostly Covered	75060	Full Covered
72364	Mostly Covered	73026	Mostly Covered	73159	Full Covered	74054	Full Covered	74442	Mostly Covered	75061	Full Covered
72395	Full Covered	73027	Mostly Covered	73160	Full Covered	74055	Full Covered	74445	Mostly Covered	75062	Full Covered
72401	Full Covered	73030	Full Covered	73162	Full Covered	74059	Mostly Covered	74447	Full Covered	75063	Full Covered
72402	Full Covered	73031	Mostly Covered	73164	Full Covered	74060	Mostly Covered	74454	Mostly Covered	75065	Full Covered
72403	Full Covered	73032	Full Covered	73165	Mostly Covered	74062	Mostly Covered	74456	Full Covered	75067	Full Covered
72404	Full Covered	73034	Full Covered	73167	Full Covered	74063	Full Covered	74458	Full Covered	75068	Full Covered
72411	Mostly Covered	73036	Full Covered	73169	Mostly Covered	74067	Mostly Covered	74501	Mostly Covered	75069	Full Covered
72416	Mostly Covered	73044	Full Covered	73170	Full Covered	74068	Mostly Covered	74502	Full Covered	75070	Full Covered
72439	Full Covered	73045	Full Covered	73172	Full Covered	74073	Mostly Covered	74522	Full Covered	75071	Full Covered
72623	Mostly Covered	73049	Mostly Covered	73173	Mostly Covered	74074	Full Covered	74546	Mostly Covered	75074	Full Covered
72626	Mostly Covered	73050	Mostly Covered	73178	Full Covered	74075	Full Covered	74554	Full Covered	75075	Full Covered
72635	Full Covered	73058	Mostly Covered	73179	Mostly Covered	74076	Full Covered	74561	Mostly Covered	75077	Full Covered
72642	Mostly Covered	73063	Mostly Covered	73184	Full Covered	74077	Full Covered	74565	Mostly Covered	75078	Mostly Covered
72651	Full Covered	73065	Full Covered	73185	Full Covered	74078	Full Covered	74601	Full Covered	75080	Full Covered
72653	Full Covered	73066	Full Covered	73189	Full Covered	74081	Mostly Covered	74602	Full Covered	75081	Full Covered
72654	Full Covered	73069	Full Covered	73190	Full Covered	74101	Full Covered	74631	Mostly Covered	75082	Full Covered
72701	Mostly Covered	73070	Full Covered	73194	Full Covered	74102	Full Covered	74644	Mostly Covered	75083	Full Covered
72702	Full Covered	73071	Full Covered	73195	Full Covered	74103	Full Covered	74801	Full Covered	75085	Full Covered
72703	Full Covered	73072	Full Covered	73196	Full Covered	74104	Full Covered	74802	Full Covered	75086	Full Covered
72704	Full Covered	73075	Full Covered	73198	Full Covered	74105	Full Covered	74804	Mostly Covered	75087	Full Covered
72711	Mostly Covered	73077	Full Covered	73301	Full Covered	74106	Full Covered	74820	Mostly Covered	75088	Full Covered
72712	Full Covered	73078	Mostly Covered	73344	Full Covered	74107	Full Covered	74821	Mostly Covered	75089	Full Covered
72714	Full Covered	73083	Full Covered	73401	Full Covered	74108	Full Covered	74842	Full Covered	75090	Full Covered
72715	Mostly Covered	73084	Mostly Covered	73402	Full Covered	74110	Full Covered	74843	Full Covered	75091	Full Covered
72716	Full Covered	73086	Mostly Covered	73403	Full Covered	74112	Full Covered	74851	Full Covered	75092	Full Covered
72718	Full Covered	73093	Full Covered	73436	Mostly Covered	74114	Full Covered	74855	Mostly Covered	75093	Full Covered
72719	Full Covered	73097	Mostly Covered	73453	Mostly Covered	74115	Full Covered	74857	Full Covered	75094	Full Covered
72728	Full Covered	73098	Full Covered	73458	Full Covered	74116	Full Covered	74865	Full Covered	75097	Full Covered
72730	Full Covered	73099	Mostly Covered	73501	Mostly Covered	74117	Mostly Covered	74872	Mostly Covered	75098	Mostly Covered
72735	Mostly Covered	73101	Full Covered	73502	Full Covered	74119	Full Covered	74873	Mostly Covered	75099	Full Covered

Zip Code	Coverage Level	Zip Code	Coverage Level	Zip Code	Coverage Level	Zip Code	Coverage Level	Zip Code	Coverage Level	Zip Code	Coverage Level
75101	Full Covered	75246	Full Covered	75428	Mostly Covered	76001	Full Covered	76124	Full Covered	76537	Full Covered
75102	Mostly Covered	75247	Full Covered	75429	Mostly Covered	76002	Full Covered	76126	Full Covered	76539	Full Covered
75104	Full Covered	75248	Full Covered	75437	Mostly Covered	76003	Full Covered	76127	Full Covered	76540	Full Covered
75106	Full Covered	75249	Full Covered	75454	Full Covered	76004	Full Covered	76129	Full Covered	76541	Full Covered
75109	Mostly Covered	75250	Full Covered	75455	Full Covered	76005	Full Covered	76130	Full Covered	76542	Full Covered
75110	Full Covered	75251	Full Covered	75456	Full Covered	76006	Full Covered	76131	Full Covered	76543	Full Covered
75115	Full Covered	75252	Full Covered	75459	Full Covered	76007	Full Covered	76132	Full Covered	76544	Mostly Covered
75116	Full Covered	75253	Full Covered	75471	Mostly Covered	76008	Full Covered	76133	Full Covered	76547	Full Covered
75118	Full Covered	75254	Full Covered	75474	Mostly Covered	76009	Mostly Covered	76134	Full Covered	76548	Full Covered
75119	Mostly Covered	75258	Full Covered	75482	Full Covered	76010	Full Covered	76135	Mostly Covered	76549	Full Covered
75120	Mostly Covered	75260	Full Covered	75483	Full Covered	76011	Full Covered	76136	Full Covered	76550	Full Covered
75123	Full Covered	75261	Full Covered	75485	Mostly Covered	76012	Full Covered	76137	Full Covered	76554	Full Covered
75126	Mostly Covered	75262	Full Covered	75487	Mostly Covered	76013	Full Covered	76140	Full Covered	76559	Mostly Covered
75132	Full Covered	75263	Full Covered	75489	Full Covered	76014	Full Covered	76147	Full Covered	76564	Full Covered
75134	Full Covered	75264	Full Covered	75491	Mostly Covered	76015	Full Covered	76148	Full Covered	76569	Mostly Covered
75137	Full Covered	75265	Full Covered	75493	Full Covered	76016	Full Covered	76155	Full Covered	76573	Mostly Covered
75138	Mostly Covered	75266	Full Covered	75495	Full Covered	76017	Full Covered	76161	Full Covered	76579	Mostly Covered
75141	Full Covered	75267	Full Covered	75496	Mostly Covered	76018	Full Covered	76162	Full Covered	76621	Mostly Covered
75146	Full Covered	75270	Full Covered	75501	Full Covered	76019	Full Covered	76163	Full Covered	76623	Mostly Covered
75149	Full Covered	75275	Full Covered	75503	Full Covered	76021	Full Covered	76164	Full Covered	76628	Full Covered
75150	Full Covered	75277	Full Covered	75504	Full Covered	76022	Full Covered	76177	Full Covered	76631	Full Covered
75151	Full Covered	75283	Full Covered	75505	Full Covered	76023	Mostly Covered	76179	Full Covered	76640	Mostly Covered
75152	Full Covered	75284	Full Covered	75507	Full Covered	76028	Full Covered	76180	Full Covered	76643	Full Covered
75153	Mostly Covered	75285	Full Covered	75558	Mostly Covered	76031	Full Covered	76181	Full Covered	76645	Full Covered
75154	Mostly Covered	75286	Full Covered	75561	Mostly Covered	76033	Mostly Covered	76182	Full Covered	76655	Mostly Covered
75155	Mostly Covered	75287	Full Covered	75567	Full Covered	76034	Full Covered	76185	Full Covered	76666	Mostly Covered
75159	Mostly Covered	75301	Full Covered	75569	Full Covered	76036	Full Covered	76191	Full Covered	76670	Mostly Covered
75160	Full Covered	75303	Full Covered	75570	Full Covered	76039	Full Covered	76192	Mostly Covered	76679	Mostly Covered
75161	Full Covered	75310	Full Covered	75573	Mostly Covered	76040	Full Covered	76193	Full Covered	76684	Mostly Covered
75165	Full Covered	75312	Full Covered	75574	Mostly Covered	76041	Mostly Covered	76195	Full Covered	76701	Full Covered
75166	Mostly Covered	75313	Full Covered	75599	Full Covered	76044	Mostly Covered	76196	Full Covered	76702	Full Covered
75167	Mostly Covered	75315	Full Covered	75601	Full Covered	76048	Full Covered	76197	Full Covered	76703	Full Covered
75168	Full Covered	75320	Full Covered	75602	Mostly Covered	76049	Mostly Covered	76198	Full Covered	76704	Full Covered
75172	Full Covered	75323	Full Covered	75603	Full Covered	76051	Full Covered	76199	Full Covered	76705	Full Covered
75173	Mostly Covered	75326	Full Covered	75604	Full Covered	76052	Full Covered	76201	Full Covered	76706	Full Covered
75180	Full Covered	75336	Full Covered	75605	Mostly Covered	76053	Full Covered	76202	Full Covered	76707	Full Covered
75181	Full Covered	75339	Full Covered	75606	Full Covered	76054	Full Covered	76203	Full Covered	76708	Full Covered
75182	Full Covered	75342	Full Covered	75607	Full Covered	76055	Mostly Covered	76204	Full Covered	76710	Full Covered
75185	Full Covered	75353	Full Covered	75608	Full Covered	76058	Full Covered	76205	Full Covered	76711	Full Covered
75187	Full Covered	75354	Full Covered	75615	Full Covered	76059	Full Covered	76206	Full Covered	76712	Mostly Covered
75189	Mostly Covered	75355	Full Covered	75636	Full Covered	76060	Full Covered	76207	Full Covered	76714	Full Covered
75201	Full Covered	75356	Full Covered	75638	Full Covered	76061	Full Covered	76208	Full Covered	76715	Full Covered
75202	Full Covered	75357	Full Covered	75647	Mostly Covered	76063	Full Covered	76209	Full Covered	76716	Full Covered
75203	Full Covered	75359	Full Covered	75650	Full Covered	76065	Full Covered	76210	Full Covered	76795	Full Covered
75204	Full Covered	75360	Full Covered	75651	Mostly Covered	76067	Full Covered	76226	Full Covered	76797	Full Covered
75205	Full Covered	75363	Full Covered	75656	Mostly Covered	76068	Full Covered	76227	Mostly Covered	76798	Full Covered
75206	Full Covered	75364	Full Covered	75659	Mostly Covered	76071	Mostly Covered	76234	Mostly Covered	76799	Full Covered
75207	Full Covered	75367	Full Covered	75660	Mostly Covered	76073	Mostly Covered	76240	Full Covered	76886	Mostly Covered
75208	Full Covered	75368	Full Covered	75662	Full Covered	76078	Full Covered	76241	Full Covered	76901	Mostly Covered
75209	Full Covered	75369	Full Covered	75663	Full Covered	76084	Mostly Covered	76244	Full Covered	76902	Full Covered
75210	Full Covered	75370	Full Covered	75666	Mostly Covered	76085	Mostly Covered	76247	Mostly Covered	76903	Full Covered
75211	Full Covered	75371	Full Covered	75668	Full Covered	76086	Full Covered	76248	Full Covered	76904	Full Covered
75212	Full Covered	75372	Full Covered	75670	Full Covered	76087	Full Covered	76249	Mostly Covered	76905	Mostly Covered
75214	Full Covered	75373	Full Covered	75671	Full Covered	76088	Mostly Covered	76250	Mostly Covered	76906	Full Covered
75215	Full Covered	75374	Full Covered	75685	Mostly Covered	76092	Full Covered	76259	Mostly Covered	76908	Full Covered
75216	Full Covered	75376	Full Covered	75693	Full Covered	76093	Mostly Covered	76262	Full Covered	76909	Full Covered
75217	Full Covered	75378	Full Covered	75694	Mostly Covered	76094	Full Covered	76266	Mostly Covered	76939	Mostly Covered
75218	Full Covered	75379	Full Covered	75701	Full Covered	76095	Full Covered	76268	Mostly Covered	77001	Full Covered
75219	Full Covered	75380	Full Covered	75702	Full Covered	76096	Full Covered	76272	Mostly Covered	77002	Full Covered
75220	Full Covered	75381	Full Covered	75703	Mostly Covered	76097	Full Covered	76299	Full Covered	77003	Full Covered
75221	Full Covered	75382	Full Covered	75704	Mostly Covered	76099	Full Covered	76301	Full Covered	77004	Full Covered
75222	Full Covered	75386	Full Covered	75705	Mostly Covered	76101	Full Covered	76302	Full Covered	77005	Full Covered
75223	Full Covered	75387	Full Covered	75706	Mostly Covered	76102	Full Covered	76305	Mostly Covered	77006	Full Covered
75224	Full Covered	75388	Full Covered	75707	Full Covered	76103	Full Covered	76306	Full Covered	77007	Full Covered
75225	Full Covered	75389	Full Covered	75708	Full Covered	76104	Full Covered	76307	Full Covered	77008	Full Covered
75226	Full Covered	75390	Full Covered	75709	Mostly Covered	76105	Full Covered	76308	Full Covered	77009	Full Covered
75227	Full Covered	75391	Full Covered	75710	Full Covered	76106	Full Covered	76309	Full Covered	77010	Full Covered
75228	Full Covered	75392	Full Covered	75711	Full Covered	76107	Full Covered	76310	Full Covered	77011	Full Covered
75229	Full Covered	75393	Full Covered	75712	Full Covered	76108	Full Covered	76311	Full Covered	77012	Full Covered
75230	Full Covered	75394	Full Covered	75713	Full Covered	76109	Full Covered	76360	Full Covered	77013	Full Covered
75231	Full Covered	75395	Full Covered	75791	Mostly Covered	76110	Full Covered	76364	Mostly Covered	77014	Full Covered
75232	Full Covered	75396	Full Covered	75798	Full Covered	76111	Full Covered	76439	Mostly Covered	77015	Full Covered
75233	Full Covered	75397	Full Covered	75799	Full Covered	76112	Full Covered	76467	Mostly Covered	77016	Full Covered
75234	Full Covered	75398	Full Covered	75901	Full Covered	76113	Full Covered	76476	Full Covered	77017	Full Covered
75235	Full Covered	75401	Full Covered	75902	Full Covered	76114	Full Covered	76484	Mostly Covered	77018	Full Covered
75236	Full Covered	75402	Full Covered	75903	Full Covered	76115	Full Covered	76485	Mostly Covered	77019	Full Covered
75237	Full Covered	75403	Full Covered	75904	Full Covered	76116	Full Covered	76501	Full Covered	77020	Full Covered
75238	Full Covered	75404	Full Covered	75915	Full Covered	76117	Full Covered	76502	Full Covered	77021	Full Covered
75240	Full Covered	75407	Mostly Covered	75941	Mostly Covered	76118	Full Covered	76503	Full Covered	77022	Full Covered
75241	Full Covered	75409	Full Covered	75962	Full Covered	76119	Full Covered	76504	Full Covered	77023	Full Covered
75242	Full Covered	75414	Mostly Covered	75963	Full Covered	76120	Full Covered	76505	Full Covered	77024	Full Covered
75243	Full Covered	75420	Mostly Covered	75964	Full Covered	76121	Full Covered	76508	Full Covered	77025	Full Covered
75244	Full Covered	75422	Mostly Covered	75965	Full Covered	76122	Full Covered	76513	Mostly Covered	77026	Full Covered
75245	Full Covered	75423	Mostly Covered	75969	Mostly Covered	76123	Full Covered	76533	Full Covered	77027	Full Covered

Zip Code	Coverage Level	Zip Code	Coverage Level	Zip Code	Coverage Level	Zip Code	Coverage Level	Zip Code	Coverage Level	Zip Code	Coverage Level
77028	Full Covered	77215	Full Covered	77335	Full Covered	77487	Full Covered	77630	Full Covered	78150	Full Covered
77029	Full Covered	77216	Full Covered	77336	Mostly Covered	77488	Full Covered	77631	Full Covered	78154	Full Covered
77030	Full Covered	77217	Full Covered	77338	Full Covered	77489	Full Covered	77632	Full Covered	78155	Full Covered
77031	Full Covered	77218	Mostly Covered	77339	Full Covered	77491	Full Covered	77639	Full Covered	78156	Mostly Covered
77032	Full Covered	77219	Full Covered	77340	Full Covered	77492	Full Covered	77641	Full Covered	78163	Mostly Covered
77033	Full Covered	77220	Full Covered	77341	Full Covered	77493	Full Covered	77642	Full Covered	78201	Full Covered
77034	Full Covered	77221	Full Covered	77342	Full Covered	77494	Full Covered	77643	Full Covered	78202	Full Covered
77035	Full Covered	77222	Full Covered	77345	Full Covered	77496	Full Covered	77651	Full Covered	78203	Full Covered
77036	Full Covered	77223	Full Covered	77346	Full Covered	77497	Full Covered	77656	Full Covered	78204	Full Covered
77037	Full Covered	77224	Mostly Covered	77347	Full Covered	77501	Full Covered	77657	Full Covered	78205	Full Covered
77038	Full Covered	77225	Full Covered	77348	Full Covered	77502	Full Covered	77659	Mostly Covered	78206	Full Covered
77039	Full Covered	77226	Full Covered	77350	Mostly Covered	77503	Full Covered	77662	Full Covered	78207	Full Covered
77040	Full Covered	77227	Full Covered	77351	Mostly Covered	77504	Full Covered	77670	Full Covered	78208	Full Covered
77041	Full Covered	77228	Full Covered	77353	Mostly Covered	77505	Full Covered	77701	Full Covered	78209	Full Covered
77042	Full Covered	77229	Full Covered	77354	Mostly Covered	77506	Full Covered	77702	Full Covered	78210	Full Covered
77043	Full Covered	77230	Full Covered	77355	Full Covered	77507	Full Covered	77703	Full Covered	78211	Full Covered
77044	Full Covered	77231	Full Covered	77357	Mostly Covered	77508	Full Covered	77704	Full Covered	78212	Full Covered
77045	Full Covered	77233	Full Covered	77358	Mostly Covered	77510	Mostly Covered	77705	Mostly Covered	78213	Full Covered
77046	Full Covered	77234	Full Covered	77362	Full Covered	77511	Full Covered	77706	Full Covered	78214	Full Covered
77047	Full Covered	77235	Full Covered	77365	Full Covered	77512	Full Covered	77707	Full Covered	78215	Full Covered
77048	Full Covered	77236	Full Covered	77367	Mostly Covered	77515	Mostly Covered	77708	Full Covered	78216	Full Covered
77049	Full Covered	77237	Full Covered	77372	Full Covered	77516	Mostly Covered	77710	Full Covered	78217	Full Covered
77050	Full Covered	77238	Full Covered	77373	Full Covered	77517	Full Covered	77713	Full Covered	78218	Full Covered
77051	Full Covered	77240	Full Covered	77375	Mostly Covered	77518	Full Covered	77720	Full Covered	78219	Full Covered
77052	Full Covered	77241	Full Covered	77377	Full Covered	77520	Mostly Covered	77725	Full Covered	78220	Full Covered
77053	Full Covered	77242	Full Covered	77378	Mostly Covered	77521	Full Covered	77726	Full Covered	78221	Mostly Covered
77054	Full Covered	77243	Full Covered	77379	Full Covered	77522	Full Covered	77801	Full Covered	78222	Mostly Covered
77055	Full Covered	77244	Full Covered	77380	Full Covered	77530	Full Covered	77802	Full Covered	78223	Mostly Covered
77056	Full Covered	77245	Full Covered	77381	Full Covered	77531	Full Covered	77803	Full Covered	78224	Mostly Covered
77057	Full Covered	77248	Full Covered	77382	Full Covered	77532	Mostly Covered	77805	Full Covered	78225	Full Covered
77058	Full Covered	77249	Full Covered	77383	Full Covered	77533	Mostly Covered	77806	Full Covered	78226	Full Covered
77059	Full Covered	77251	Full Covered	77384	Full Covered	77534	Mostly Covered	77807	Full Covered	78227	Full Covered
77060	Full Covered	77252	Full Covered	77385	Full Covered	77535	Mostly Covered	77808	Mostly Covered	78228	Full Covered
77061	Full Covered	77253	Full Covered	77386	Full Covered	77536	Full Covered	77830	Mostly Covered	78229	Full Covered
77062	Full Covered	77254	Full Covered	77387	Full Covered	77538	Mostly Covered	77833	Full Covered	78230	Full Covered
77063	Full Covered	77255	Full Covered	77388	Full Covered	77539	Full Covered	77834	Full Covered	78231	Full Covered
77064	Full Covered	77256	Full Covered	77389	Full Covered	77541	Full Covered	77840	Full Covered	78232	Full Covered
77065	Full Covered	77257	Full Covered	77391	Full Covered	77542	Full Covered	77841	Full Covered	78233	Full Covered
77066	Full Covered	77258	Full Covered	77393	Full Covered	77545	Full Covered	77842	Full Covered	78234	Full Covered
77067	Full Covered	77259	Full Covered	77396	Full Covered	77546	Full Covered	77843	Full Covered	78235	Full Covered
77068	Full Covered	77261	Full Covered	77401	Full Covered	77547	Full Covered	77844	Full Covered	78236	Full Covered
77069	Full Covered	77262	Full Covered	77402	Full Covered	77549	Full Covered	77845	Full Covered	78237	Full Covered
77070	Full Covered	77263	Full Covered	77404	Full Covered	77550	Full Covered	77862	Mostly Covered	78238	Full Covered
77071	Full Covered	77265	Full Covered	77406	Full Covered	77551	Full Covered	77866	Mostly Covered	78239	Full Covered
77072	Full Covered	77266	Full Covered	77410	Full Covered	77552	Full Covered	77868	Full Covered	78240	Full Covered
77073	Full Covered	77267	Full Covered	77411	Full Covered	77553	Full Covered	77878	Mostly Covered	78242	Mostly Covered
77074	Full Covered	77268	Full Covered	77413	Full Covered	77554	Full Covered	77880	Mostly Covered	78243	Full Covered
77075	Full Covered	77269	Full Covered	77415	Mostly Covered	77555	Full Covered	77881	Full Covered	78244	Full Covered
77076	Full Covered	77270	Full Covered	77417	Mostly Covered	77560	Mostly Covered	77901	Full Covered	78245	Full Covered
77077	Mostly Covered	77271	Full Covered	77418	Mostly Covered	77561	Mostly Covered	77902	Full Covered	78246	Full Covered
77078	Full Covered	77272	Full Covered	77420	Full Covered	77562	Full Covered	77903	Full Covered	78247	Full Covered
77079	Mostly Covered	77273	Full Covered	77422	Full Covered	77563	Mostly Covered	77904	Mostly Covered	78248	Full Covered
77080	Full Covered	77274	Full Covered	77423	Mostly Covered	77564	Mostly Covered	77905	Full Covered	78249	Full Covered
77081	Full Covered	77275	Full Covered	77426	Mostly Covered	77565	Full Covered	77951	Mostly Covered	78250	Full Covered
77082	Mostly Covered	77277	Full Covered	77429	Full Covered	77566	Mostly Covered	77968	Mostly Covered	78251	Full Covered
77083	Mostly Covered	77279	Mostly Covered	77433	Mostly Covered	77568	Full Covered	77977	Mostly Covered	78252	Full Covered
77084	Mostly Covered	77280	Full Covered	77441	Mostly Covered	77571	Full Covered	77988	Full Covered	78253	Full Covered
77085	Full Covered	77281	Full Covered	77443	Mostly Covered	77572	Full Covered	78002	Mostly Covered	78254	Full Covered
77086	Full Covered	77282	Mostly Covered	77445	Full Covered	77573	Full Covered	78012	Mostly Covered	78255	Full Covered
77087	Full Covered	77284	Full Covered	77446	Mostly Covered	77574	Full Covered	78015	Mostly Covered	78256	Full Covered
77088	Full Covered	77287	Full Covered	77447	Full Covered	77575	Full Covered	78023	Mostly Covered	78257	Full Covered
77089	Full Covered	77288	Full Covered	77448	Mostly Covered	77577	Mostly Covered	78028	Full Covered	78258	Full Covered
77090	Full Covered	77289	Full Covered	77449	Full Covered	77578	Mostly Covered	78029	Full Covered	78259	Full Covered
77091	Full Covered	77290	Full Covered	77450	Full Covered	77580	Mostly Covered	78040	Full Covered	78260	Mostly Covered
77092	Full Covered	77291	Full Covered	77452	Full Covered	77581	Full Covered	78042	Full Covered	78261	Full Covered
77093	Full Covered	77292	Full Covered	77453	Full Covered	77582	Full Covered	78044	Full Covered	78265	Full Covered
77094	Mostly Covered	77293	Full Covered	77456	Mostly Covered	77583	Full Covered	78045	Mostly Covered	78266	Full Covered
77095	Full Covered	77297	Full Covered	77459	Full Covered	77584	Full Covered	78046	Mostly Covered	78268	Full Covered
77096	Full Covered	77298	Full Covered	77463	Mostly Covered	77586	Full Covered	78049	Full Covered	78269	Full Covered
77097	Full Covered	77299	Full Covered	77464	Mostly Covered	77587	Full Covered	78050	Full Covered	78270	Full Covered
77098	Full Covered	77301	Full Covered	77466	Mostly Covered	77588	Full Covered	78054	Full Covered	78275	Full Covered
77099	Full Covered	77302	Full Covered	77467	Mostly Covered	77590	Mostly Covered	78064	Full Covered	78278	Full Covered
77201	Full Covered	77303	Mostly Covered	77468	Mostly Covered	77591	Full Covered	78108	Mostly Covered	78279	Full Covered
77202	Full Covered	77304	Full Covered	77469	Full Covered	77592	Full Covered	78109	Full Covered	78280	Full Covered
77203	Full Covered	77305	Full Covered	77471	Full Covered	77597	Full Covered	78115	Mostly Covered	78283	Full Covered
77204	Full Covered	77306	Mostly Covered	77477	Full Covered	77598	Full Covered	78122	Mostly Covered	78284	Full Covered
77205	Full Covered	77315	Full Covered	77478	Full Covered	77611	Mostly Covered	78123	Mostly Covered	78285	Full Covered
77206	Full Covered	77316	Mostly Covered	77479	Full Covered	77613	Full Covered	78124	Mostly Covered	78286	Full Covered
77207	Full Covered	77318	Full Covered	77480	Mostly Covered	77614	Mostly Covered	78130	Full Covered	78287	Full Covered
77208	Full Covered	77320	Mostly Covered	77481	Full Covered	77615	Mostly Covered	78131	Full Covered	78288	Full Covered
77209	Full Covered	77325	Full Covered	77482	Full Covered	77619	Full Covered	78132	Full Covered	78289	Full Covered
77210	Full Covered	77326	Mostly Covered	77483	Mostly Covered	77626	Full Covered	78135	Full Covered	78291	Full Covered
77212	Full Covered	77328	Mostly Covered	77484	Mostly Covered	77627	Full Covered	78140	Mostly Covered	78292	Full Covered
77213	Full Covered	77334	Full Covered	77486	Mostly Covered	77629	Full Covered	78148	Full Covered	78293	Full Covered

Zip Code	Coverage Level	Zip Code	Coverage Level	Zip Code	Coverage Level	Zip Code	Coverage Level	Zip Code	Coverage Level	Zip Code	Coverage Level
80237	Full Covered	80502	Full Covered	80941	Full Covered	83720	Full Covered	84415	Full Covered	85079	Full Covered
80238	Full Covered	80503	Mostly Covered	80942	Full Covered	83721	Full Covered	84601	Full Covered	85080	Full Covered
80239	Full Covered	80504	Full Covered	80943	Full Covered	83722	Full Covered	84602	Full Covered	85082	Full Covered
80241	Full Covered	80513	Full Covered	80944	Full Covered	83723	Full Covered	84603	Full Covered	85085	Full Covered
80243	Full Covered	80514	Full Covered	80945	Full Covered	83724	Full Covered	84604	Full Covered	85086	Mostly Covered
80244	Full Covered	80515	Mostly Covered	80946	Full Covered	83725	Full Covered	84605	Full Covered	85098	Full Covered
80246	Full Covered	80516	Full Covered	80947	Full Covered	83726	Full Covered	84606	Full Covered	85099	Full Covered
80247	Full Covered	80520	Full Covered	80949	Full Covered	83727	Full Covered	84660	Mostly Covered	85201	Full Covered
80248	Full Covered	80521	Full Covered	80950	Full Covered	83728	Full Covered	84663	Full Covered	85202	Full Covered
80249	Full Covered	80522	Mostly Covered	80960	Full Covered	83729	Full Covered	84664	Mostly Covered	85203	Full Covered
80250	Full Covered	80523	Full Covered	80962	Full Covered	83730	Full Covered	84765	Mostly Covered	85204	Full Covered
80251	Full Covered	80525	Mostly Covered	80970	Full Covered	83731	Full Covered	84771	Full Covered	85205	Full Covered
80252	Full Covered	80526	Full Covered	80977	Mostly Covered	83732	Full Covered	84780	Full Covered	85206	Full Covered
80255	Full Covered	80527	Full Covered	80995	Full Covered	83733	Full Covered	84790	Full Covered	85207	Full Covered
80256	Full Covered	80530	Full Covered	81001	Full Covered	83735	Full Covered	84791	Full Covered	85208	Full Covered
80257	Full Covered	80533	Mostly Covered	81002	Full Covered	83744	Mostly Covered	85001	Full Covered	85210	Full Covered
80259	Full Covered	80534	Mostly Covered	81003	Full Covered	83756	Full Covered	85002	Full Covered	85211	Full Covered
80260	Full Covered	80537	Mostly Covered	81006	Mostly Covered	83799	Mostly Covered	85003	Full Covered	85212	Full Covered
80261	Full Covered	80538	Full Covered	81008	Full Covered	83814	Full Covered	85004	Full Covered	85213	Full Covered
80262	Full Covered	80539	Mostly Covered	81009	Full Covered	83815	Full Covered	85005	Full Covered	85214	Full Covered
80263	Full Covered	80540	Mostly Covered	81010	Full Covered	83816	Full Covered	85006	Full Covered	85215	Full Covered
80264	Full Covered	80541	Mostly Covered	81011	Full Covered	83832	Full Covered	85007	Full Covered	85216	Full Covered
80265	Full Covered	80542	Full Covered	81012	Full Covered	83833	Mostly Covered	85008	Full Covered	85217	Full Covered
80266	Full Covered	80543	Mostly Covered	81101	Full Covered	83843	Full Covered	85009	Full Covered	85219	Full Covered
80270	Full Covered	80544	Full Covered	81102	Full Covered	83844	Full Covered	85010	Full Covered	85220	Full Covered
80271	Full Covered	80551	Mostly Covered	81220	Mostly Covered	83877	Mostly Covered	85011	Full Covered	85221	Full Covered
80273	Full Covered	80553	Mostly Covered	81302	Full Covered	84003	Mostly Covered	85012	Full Covered	85223	Mostly Covered
80274	Full Covered	80601	Mostly Covered	81303	Mostly Covered	84006	Mostly Covered	85013	Full Covered	85224	Full Covered
80275	Full Covered	80602	Full Covered	81501	Full Covered	84011	Mostly Covered	85014	Full Covered	85225	Full Covered
80279	Full Covered	80603	Mostly Covered	81502	Full Covered	84013	Mostly Covered	85015	Full Covered	85226	Full Covered
80280	Full Covered	80614	Full Covered	81503	Full Covered	84014	Mostly Covered	85016	Full Covered	85228	Mostly Covered
80281	Full Covered	80615	Mostly Covered	81504	Full Covered	84015	Full Covered	85017	Full Covered	85230	Mostly Covered
80285	Full Covered	80620	Full Covered	81505	Mostly Covered	84016	Full Covered	85018	Full Covered	85233	Full Covered
80290	Full Covered	80621	Full Covered	81506	Full Covered	84024	Mostly Covered	85019	Full Covered	85234	Full Covered
80291	Full Covered	80622	Mostly Covered	81520	Mostly Covered	84025	Full Covered	85020	Full Covered	85236	Mostly Covered
80292	Full Covered	80623	Full Covered	81601	Full Covered	84033	Mostly Covered	85021	Full Covered	85244	Full Covered
80293	Full Covered	80631	Full Covered	81602	Full Covered	84037	Full Covered	85022	Full Covered	85245	Mostly Covered
80294	Full Covered	80632	Full Covered	81611	Full Covered	84040	Full Covered	85023	Full Covered	85246	Full Covered
80295	Full Covered	80633	Full Covered	81612	Full Covered	84041	Full Covered	85024	Full Covered	85247	Full Covered
80299	Full Covered	80634	Full Covered	81615	Mostly Covered	84042	Mostly Covered	85025	Full Covered	85248	Full Covered
80301	Full Covered	80638	Full Covered	81620	Full Covered	84043	Full Covered	85026	Full Covered	85249	Full Covered
80302	Full Covered	80639	Full Covered	81645	Full Covered	84044	Mostly Covered	85027	Full Covered	85250	Full Covered
80303	Full Covered	80640	Full Covered	81649	Full Covered	84056	Full Covered	85028	Full Covered	85251	Full Covered
80304	Full Covered	80645	Mostly Covered	81655	Full Covered	84057	Full Covered	85029	Full Covered	85252	Full Covered
80305	Full Covered	80646	Full Covered	81656	Mostly Covered	84058	Full Covered	85030	Full Covered	85253	Full Covered
80306	Full Covered	80651	Mostly Covered	81657	Full Covered	84059	Full Covered	85031	Full Covered	85254	Full Covered
80307	Full Covered	80701	Full Covered	81658	Full Covered	84062	Mostly Covered	85032	Full Covered	85255	Mostly Covered
80308	Full Covered	80705	Full Covered	82001	Full Covered	84067	Full Covered	85033	Mostly Covered	85256	Mostly Covered
80309	Full Covered	80722	Mostly Covered	82003	Full Covered	84075	Full Covered	85034	Full Covered	85257	Full Covered
80310	Full Covered	80751	Full Covered	82005	Mostly Covered	84087	Mostly Covered	85035	Mostly Covered	85258	Full Covered
80314	Full Covered	80809	Mostly Covered	82006	Mostly Covered	84089	Full Covered	85036	Full Covered	85259	Full Covered
80321	Full Covered	80819	Mostly Covered	82007	Mostly Covered	84097	Full Covered	85037	Full Covered	85260	Full Covered
80322	Full Covered	80829	Full Covered	82008	Full Covered	84098	Mostly Covered	85038	Full Covered	85261	Full Covered
80323	Full Covered	80840	Full Covered	82602	Full Covered	84128	Mostly Covered	85040	Full Covered	85266	Full Covered
80328	Full Covered	80841	Full Covered	82605	Mostly Covered	84201	Full Covered	85041	Full Covered	85267	Full Covered
80329	Full Covered	80901	Full Covered	82609	Full Covered	84244	Mostly Covered	85042	Full Covered	85268	Mostly Covered
80401	Full Covered	80903	Full Covered	82615	Mostly Covered	84301	Mostly Covered	85043	Mostly Covered	85271	Full Covered
80402	Full Covered	80904	Full Covered	82644	Mostly Covered	84302	Full Covered	85044	Full Covered	85274	Full Covered
80403	Full Covered	80905	Full Covered	83303	Full Covered	84314	Mostly Covered	85045	Mostly Covered	85275	Full Covered
80419	Full Covered	80906	Full Covered	83328	Full Covered	84315	Full Covered	85046	Full Covered	85277	Full Covered
80422	Full Covered	80907	Full Covered	83341	Mostly Covered	84318	Full Covered	85048	Full Covered	85278	Full Covered
80424	Mostly Covered	80908	Full Covered	83403	Full Covered	84319	Mostly Covered	85050	Full Covered	85280	Full Covered
80425	Mostly Covered	80909	Full Covered	83404	Full Covered	84321	Mostly Covered	85051	Full Covered	85281	Full Covered
80427	Full Covered	80910	Full Covered	83405	Full Covered	84322	Full Covered	85053	Full Covered	85282	Full Covered
80433	Full Covered	80911	Mostly Covered	83406	Full Covered	84323	Full Covered	85054	Full Covered	85283	Full Covered
80435	Full Covered	80913	Mostly Covered	83415	Full Covered	84324	Full Covered	85055	Full Covered	85284	Full Covered
80436	Full Covered	80914	Full Covered	83427	Mostly Covered	84326	Full Covered	85060	Full Covered	85285	Full Covered
80437	Mostly Covered	80915	Mostly Covered	83454	Full Covered	84328	Mostly Covered	85061	Full Covered	85287	Full Covered
80439	Mostly Covered	80916	Full Covered	83701	Full Covered	84332	Full Covered	85062	Full Covered	85296	Full Covered
80443	Mostly Covered	80917	Full Covered	83702	Full Covered	84333	Mostly Covered	85063	Full Covered	85297	Mostly Covered
80453	Full Covered	80918	Full Covered	83703	Full Covered	84335	Mostly Covered	85064	Mostly Covered	85299	Full Covered
80454	Full Covered	80919	Full Covered	83704	Mostly Covered	84339	Mostly Covered	85065	Full Covered	85301	Full Covered
80455	Full Covered	80920	Full Covered	83705	Full Covered	84340	Mostly Covered	85066	Full Covered	85302	Full Covered
80457	Full Covered	80921	Mostly Covered	83706	Full Covered	84341	Full Covered	85067	Full Covered	85303	Full Covered
80465	Full Covered	80922	Mostly Covered	83707	Full Covered	84401	Full Covered	85068	Full Covered	85304	Full Covered
80470	Mostly Covered	80926	Full Covered	83708	Full Covered	84402	Full Covered	85069	Full Covered	85305	Full Covered
80471	Mostly Covered	80931	Mostly Covered	83709	Mostly Covered	84403	Full Covered	85070	Full Covered	85306	Full Covered
80474	Mostly Covered	80932	Full Covered	83711	Mostly Covered	84404	Full Covered	85071	Full Covered	85307	Full Covered
80477	Full Covered	80933	Full Covered	83712	Full Covered	84405	Full Covered	85072	Full Covered	85308	Full Covered
80481	Mostly Covered	80934	Full Covered	83714	Mostly Covered	84407	Full Covered	85073	Full Covered	85309	Full Covered
80487	Full Covered	80935	Full Covered	83715	Full Covered	84408	Full Covered	85074	Full Covered	85310	Full Covered
80488	Full Covered	80936	Full Covered	83716	Mostly Covered	84409	Full Covered	85075	Mostly Covered	85311	Full Covered
80497	Full Covered	80937	Full Covered	83717	Full Covered	84412	Full Covered	85076	Full Covered	85312	Full Covered
80501	Full Covered	80940	Full Covered	83719	Full Covered	84414	Mostly Covered	85078	Full Covered	85313	Full Covered

Zip Code	Coverage Level	Zip Code	Coverage Level	Zip Code	Coverage Level	Zip Code	Coverage Level	Zip Code	Coverage Level	Zip Code	Coverage Level
85318	Full Covered	85750	Mostly Covered	87199	Full Covered	88534	Full Covered	89086	Full Covered	89502	Full Covered
85329	Mostly Covered	85751	Full Covered	87402	Mostly Covered	88535	Full Covered	89101	Full Covered	89503	Full Covered
85335	Full Covered	85752	Full Covered	87417	Mostly Covered	88536	Full Covered	89102	Full Covered	89504	Full Covered
85339	Mostly Covered	85754	Full Covered	87499	Full Covered	88538	Full Covered	89103	Full Covered	89505	Full Covered
85340	Mostly Covered	85775	Full Covered	87502	Full Covered	88539	Full Covered	89104	Full Covered	89506	Mostly Covered
85345	Full Covered	86002	Full Covered	87503	Full Covered	88540	Full Covered	89106	Full Covered	89507	Full Covered
85350	Mostly Covered	86003	Full Covered	87504	Full Covered	88541	Full Covered	89107	Full Covered	89509	Full Covered
85351	Full Covered	86011	Full Covered	87505	Full Covered	88542	Full Covered	89108	Full Covered	89511	Mostly Covered
85355	Mostly Covered	86301	Mostly Covered	87506	Mostly Covered	88543	Full Covered	89109	Full Covered	89512	Full Covered
85360	Full Covered	86302	Full Covered	87508	Mostly Covered	88544	Full Covered	89110	Full Covered	89513	Full Covered
85361	Mostly Covered	86303	Full Covered	87509	Full Covered	88545	Full Covered	89111	Full Covered	89515	Full Covered
85362	Full Covered	86304	Full Covered	87538	Full Covered	88546	Full Covered	89112	Full Covered	89520	Full Covered
85363	Full Covered	86313	Full Covered	87544	Full Covered	88547	Full Covered	89113	Full Covered	89521	Mostly Covered
85364	Full Covered	86324	Mostly Covered	87545	Full Covered	88548	Full Covered	89114	Full Covered	89523	Mostly Covered
85365	Full Covered	86326	Full Covered	87574	Full Covered	88549	Full Covered	89115	Full Covered	89533	Full Covered
85366	Full Covered	86330	Full Covered	87592	Full Covered	88550	Full Covered	89116	Full Covered	89555	Full Covered
85369	Full Covered	86331	Full Covered	87594	Full Covered	88553	Full Covered	89117	Full Covered	89557	Full Covered
85372	Full Covered	86338	Mostly Covered	87823	Full Covered	88554	Full Covered	89118	Full Covered	89570	Full Covered
85374	Full Covered	86402	Full Covered	87828	Mostly Covered	88555	Full Covered	89119	Full Covered	89595	Full Covered
85375	Full Covered	86403	Mostly Covered	87832	Mostly Covered	88556	Full Covered	89120	Full Covered	89701	Mostly Covered
85376	Full Covered	86404	Full Covered	88001	Full Covered	88557	Full Covered	89121	Full Covered	89702	Full Covered
85378	Full Covered	86405	Mostly Covered	88003	Mostly Covered	88558	Full Covered	89122	Mostly Covered	89703	Mostly Covered
85379	Full Covered	86411	Full Covered	88004	Full Covered	88559	Full Covered	89123	Full Covered	89704	Full Covered
85380	Full Covered	86412	Full Covered	88006	Full Covered	88560	Full Covered	89124	Full Covered	89705	Mostly Covered
85381	Full Covered	86426	Full Covered	88007	Mostly Covered	88561	Full Covered	89125	Full Covered	89706	Mostly Covered
85382	Full Covered	86427	Full Covered	88008	Mostly Covered	88562	Full Covered	89126	Full Covered	89711	Full Covered
85383	Mostly Covered	86429	Full Covered	88011	Mostly Covered	88563	Full Covered	89127	Full Covered	89712	Full Covered
85385	Full Covered	86430	Full Covered	88022	Full Covered	88565	Full Covered	89128	Full Covered	89713	Full Covered
85387	Mostly Covered	86431	Full Covered	88026	Full Covered	88566	Full Covered	89129	Full Covered	89714	Full Covered
85613	Full Covered	86439	Full Covered	88032	Mostly Covered	88567	Full Covered	89130	Full Covered	89721	Full Covered
85615	Mostly Covered	86446	Full Covered	88033	Mostly Covered	88568	Full Covered	89131	Mostly Covered	90001	Full Covered
85616	Mostly Covered	87008	Full Covered	88036	Full Covered	88569	Full Covered	89132	Full Covered	90002	Full Covered
85621	Full Covered	87021	Full Covered	88041	Mostly Covered	88570	Full Covered	89133	Full Covered	90003	Full Covered
85628	Full Covered	87022	Mostly Covered	88046	Mostly Covered	88571	Full Covered	89134	Full Covered	90004	Full Covered
85635	Mostly Covered	87031	Full Covered	88052	Mostly Covered	88572	Full Covered	89135	Full Covered	90005	Full Covered
85636	Full Covered	87043	Full Covered	88053	Full Covered	88573	Full Covered	89136	Full Covered	90006	Full Covered
85641	Full Covered	87047	Mostly Covered	88061	Full Covered	88574	Full Covered	89137	Full Covered	90007	Full Covered
85648	Mostly Covered	87048	Mostly Covered	88062	Full Covered	88575	Full Covered	89138	Full Covered	90008	Full Covered
85650	Full Covered	87051	Full Covered	88063	Full Covered	88576	Full Covered	89139	Full Covered	90009	Full Covered
85652	Full Covered	87060	Full Covered	88065	Mostly Covered	88577	Full Covered	89141	Full Covered	90010	Full Covered
85654	Full Covered	87068	Mostly Covered	88201	Full Covered	88578	Full Covered	89142	Full Covered	90011	Full Covered
85662	Full Covered	87101	Mostly Covered	88202	Mostly Covered	88579	Full Covered	89143	Mostly Covered	90012	Full Covered
85670	Full Covered	87102	Mostly Covered	88210	Mostly Covered	88580	Full Covered	89144	Full Covered	90013	Full Covered
85701	Full Covered	87103	Mostly Covered	88211	Full Covered	88581	Full Covered	89145	Full Covered	90014	Full Covered
85702	Full Covered	87104	Full Covered	88221	Full Covered	88582	Full Covered	89146	Full Covered	90015	Full Covered
85703	Full Covered	87105	Mostly Covered	88241	Full Covered	88583	Full Covered	89147	Full Covered	90016	Full Covered
85704	Full Covered	87106	Full Covered	88242	Mostly Covered	88584	Full Covered	89148	Full Covered	90017	Full Covered
85705	Full Covered	87107	Mostly Covered	88244	Full Covered	88585	Full Covered	89149	Full Covered	90018	Full Covered
85706	Full Covered	87108	Full Covered	88253	Mostly Covered	88586	Full Covered	89150	Full Covered	90019	Full Covered
85707	Full Covered	87109	Full Covered	88260	Mostly Covered	88587	Full Covered	89151	Full Covered	90020	Full Covered
85708	Full Covered	87110	Full Covered	88311	Full Covered	88588	Full Covered	89152	Full Covered	90021	Full Covered
85709	Full Covered	87111	Full Covered	88312	Full Covered	88589	Full Covered	89153	Full Covered	90022	Full Covered
85710	Full Covered	87112	Full Covered	88323	Mostly Covered	88590	Full Covered	89154	Full Covered	90023	Full Covered
85711	Full Covered	87113	Mostly Covered	88324	Mostly Covered	88595	Full Covered	89155	Full Covered	90024	Full Covered
85712	Full Covered	87114	Full Covered	88325	Mostly Covered	88901	Full Covered	89156	Full Covered	90025	Full Covered
85713	Full Covered	87115	Mostly Covered	88337	Mostly Covered	88905	Full Covered	89159	Full Covered	90026	Full Covered
85714	Full Covered	87116	Full Covered	88341	Mostly Covered	89004	Mostly Covered	89160	Full Covered	90027	Full Covered
85715	Full Covered	87117	Full Covered	88345	Full Covered	89005	Full Covered	89162	Full Covered	90028	Full Covered
85716	Full Covered	87118	Full Covered	88346	Mostly Covered	89006	Full Covered	89163	Full Covered	90029	Full Covered
85717	Full Covered	87119	Mostly Covered	88349	Full Covered	89009	Mostly Covered	89164	Full Covered	90030	Full Covered
85718	Full Covered	87120	Full Covered	88355	Full Covered	89011	Mostly Covered	89170	Full Covered	90031	Full Covered
85719	Full Covered	87121	Full Covered	88510	Full Covered	89012	Full Covered	89173	Full Covered	90032	Full Covered
85721	Full Covered	87122	Full Covered	88511	Full Covered	89014	Mostly Covered	89177	Full Covered	90033	Full Covered
85722	Full Covered	87123	Full Covered	88512	Full Covered	89015	Mostly Covered	89180	Full Covered	90034	Full Covered
85723	Full Covered	87125	Mostly Covered	88513	Full Covered	89016	Mostly Covered	89185	Full Covered	90035	Full Covered
85724	Full Covered	87131	Full Covered	88514	Full Covered	89019	Mostly Covered	89191	Full Covered	90036	Full Covered
85725	Full Covered	87151	Mostly Covered	88515	Full Covered	89020	Mostly Covered	89193	Full Covered	90037	Full Covered
85726	Full Covered	87153	Full Covered	88516	Full Covered	89023	Full Covered	89195	Full Covered	90038	Full Covered
85728	Full Covered	87154	Full Covered	88517	Full Covered	89028	Full Covered	89199	Full Covered	90039	Full Covered
85730	Mostly Covered	87158	Mostly Covered	88518	Full Covered	89029	Mostly Covered	89402	Mostly Covered	90040	Full Covered
85731	Full Covered	87176	Full Covered	88519	Full Covered	89030	Full Covered	89411	Full Covered	90041	Full Covered
85732	Full Covered	87181	Full Covered	88520	Full Covered	89031	Full Covered	89413	Full Covered	90042	Full Covered
85733	Full Covered	87184	Mostly Covered	88521	Full Covered	89032	Full Covered	89428	Full Covered	90043	Full Covered
85734	Full Covered	87185	Full Covered	88523	Full Covered	89033	Full Covered	89431	Full Covered	90044	Full Covered
85737	Full Covered	87187	Mostly Covered	88524	Full Covered	89036	Full Covered	89432	Full Covered	90045	Full Covered
85738	Full Covered	87190	Full Covered	88525	Full Covered	89041	Full Covered	89433	Full Covered	90046	Full Covered
85740	Full Covered	87191	Full Covered	88526	Full Covered	89048	Full Covered	89434	Mostly Covered	90047	Full Covered
85741	Mostly Covered	87192	Full Covered	88527	Full Covered	89052	Full Covered	89435	Full Covered	90048	Full Covered
85742	Full Covered	87193	Mostly Covered	88528	Full Covered	89053	Full Covered	89436	Mostly Covered	90049	Full Covered
85743	Full Covered	87194	Full Covered	88529	Full Covered	89060	Full Covered	89439	Mostly Covered	90050	Full Covered
85744	Mostly Covered	87195	Full Covered	88530	Full Covered	89061	Mostly Covered	89448	Full Covered	90051	Full Covered
85745	Full Covered	87196	Full Covered	88531	Full Covered	89074	Full Covered	89449	Full Covered	90052	Full Covered
85746	Mostly Covered	87197	Mostly Covered	88532	Full Covered	89077	Mostly Covered	89460	Full Covered	90053	Full Covered
85747	Mostly Covered	87198	Full Covered	88533	Full Covered	89084	Full Covered	89501	Full Covered	90054	Full Covered

Zip Code	Coverage Level	Zip Code	Coverage Level	Zip Code	Coverage Level	Zip Code	Coverage Level	Zip Code	Coverage Level	Zip Code	Coverage Level
92008	Full Covered	92134	Full Covered	92270	Full Covered	92532	Mostly Covered	92690	Full Covered	92899	Full Covered
92009	Full Covered	92135	Full Covered	92276	Full Covered	92548	Mostly Covered	92691	Full Covered	93001	Full Covered
92013	Full Covered	92136	Full Covered	92292	Full Covered	92549	Full Covered	92692	Full Covered	93002	Mostly Covered
92014	Full Covered	92137	Full Covered	92305	Full Covered	92551	Full Covered	92693	Full Covered	93003	Mostly Covered
92018	Full Covered	92138	Full Covered	92307	Mostly Covered	92552	Full Covered	92694	Full Covered	93004	Mostly Covered
92019	Full Covered	92139	Full Covered	92311	Mostly Covered	92553	Full Covered	92697	Full Covered	93005	Mostly Covered
92020	Full Covered	92140	Full Covered	92312	Full Covered	92554	Full Covered	92698	Full Covered	93006	Mostly Covered
92021	Full Covered	92142	Full Covered	92313	Full Covered	92555	Full Covered	92701	Full Covered	93007	Mostly Covered
92022	Full Covered	92143	Full Covered	92314	Full Covered	92556	Full Covered	92702	Full Covered	93009	Mostly Covered
92023	Full Covered	92145	Full Covered	92315	Full Covered	92557	Full Covered	92703	Full Covered	93010	Full Covered
92024	Full Covered	92147	Full Covered	92316	Full Covered	92562	Full Covered	92704	Full Covered	93011	Full Covered
92025	Full Covered	92149	Full Covered	92317	Full Covered	92563	Full Covered	92705	Full Covered	93012	Full Covered
92026	Full Covered	92150	Full Covered	92318	Full Covered	92564	Full Covered	92706	Full Covered	93013	Full Covered
92027	Mostly Covered	92152	Full Covered	92320	Mostly Covered	92567	Mostly Covered	92707	Full Covered	93014	Full Covered
92028	Full Covered	92153	Full Covered	92321	Full Covered	92571	Full Covered	92708	Full Covered	93016	Mostly Covered
92029	Full Covered	92154	Full Covered	92322	Full Covered	92572	Mostly Covered	92711	Full Covered	93020	Mostly Covered
92030	Mostly Covered	92155	Full Covered	92324	Full Covered	92581	Mostly Covered	92712	Full Covered	93021	Mostly Covered
92033	Full Covered	92158	Full Covered	92325	Full Covered	92582	Mostly Covered	92725	Full Covered	93022	Mostly Covered
92037	Full Covered	92159	Full Covered	92326	Full Covered	92583	Mostly Covered	92728	Full Covered	93030	Mostly Covered
92038	Full Covered	92160	Full Covered	92333	Full Covered	92584	Full Covered	92735	Full Covered	93031	Mostly Covered
92039	Full Covered	92161	Full Covered	92334	Mostly Covered	92585	Mostly Covered	92780	Full Covered	93032	Mostly Covered
92040	Full Covered	92162	Full Covered	92335	Mostly Covered	92586	Full Covered	92781	Full Covered	93033	Full Covered
92046	Full Covered	92163	Full Covered	92337	Mostly Covered	92587	Full Covered	92782	Full Covered	93034	Mostly Covered
92049	Full Covered	92164	Full Covered	92339	Mostly Covered	92589	Full Covered	92799	Full Covered	93036	Mostly Covered
92051	Full Covered	92165	Full Covered	92340	Mostly Covered	92590	Full Covered	92801	Full Covered	93040	Mostly Covered
92052	Full Covered	92166	Full Covered	92341	Mostly Covered	92591	Full Covered	92802	Full Covered	93041	Mostly Covered
92054	Full Covered	92167	Full Covered	92346	Full Covered	92593	Full Covered	92803	Full Covered	93042	Full Covered
92055	Mostly Covered	92168	Full Covered	92350	Full Covered	92595	Full Covered	92804	Full Covered	93043	Mostly Covered
92056	Full Covered	92169	Full Covered	92352	Full Covered	92596	Mostly Covered	92805	Full Covered	93044	Mostly Covered
92057	Full Covered	92170	Full Covered	92354	Full Covered	92599	Full Covered	92806	Full Covered	93060	Full Covered
92058	Full Covered	92171	Full Covered	92357	Full Covered	92602	Full Covered	92807	Full Covered	93061	Full Covered
92064	Full Covered	92172	Full Covered	92359	Mostly Covered	92603	Full Covered	92808	Full Covered	93062	Full Covered
92065	Mostly Covered	92173	Full Covered	92368	Full Covered	92604	Full Covered	92809	Full Covered	93063	Full Covered
92067	Full Covered	92174	Full Covered	92369	Full Covered	92605	Full Covered	92811	Full Covered	93064	Full Covered
92068	Full Covered	92175	Full Covered	92373	Full Covered	92606	Full Covered	92812	Full Covered	93065	Full Covered
92069	Full Covered	92176	Full Covered	92374	Full Covered	92607	Full Covered	92814	Full Covered	93066	Full Covered
92071	Full Covered	92177	Full Covered	92375	Full Covered	92609	Full Covered	92815	Full Covered	93067	Full Covered
92072	Full Covered	92178	Full Covered	92376	Full Covered	92610	Full Covered	92816	Full Covered	93094	Mostly Covered
92074	Full Covered	92179	Full Covered	92377	Mostly Covered	92612	Full Covered	92817	Full Covered	93099	Full Covered
92075	Full Covered	92182	Full Covered	92378	Full Covered	92614	Full Covered	92821	Full Covered	93101	Full Covered
92078	Full Covered	92184	Full Covered	92382	Full Covered	92615	Full Covered	92822	Full Covered	93102	Full Covered
92079	Full Covered	92186	Full Covered	92385	Full Covered	92616	Full Covered	92823	Mostly Covered	93103	Full Covered
92081	Full Covered	92187	Full Covered	92386	Full Covered	92618	Full Covered	92825	Full Covered	93105	Mostly Covered
92083	Full Covered	92190	Full Covered	92391	Full Covered	92619	Full Covered	92831	Full Covered	93106	Mostly Covered
92084	Full Covered	92191	Full Covered	92392	Mostly Covered	92620	Full Covered	92832	Full Covered	93107	Mostly Covered
92085	Full Covered	92192	Full Covered	92393	Full Covered	92623	Full Covered	92833	Full Covered	93108	Full Covered
92088	Full Covered	92193	Full Covered	92394	Full Covered	92624	Full Covered	92834	Full Covered	93109	Full Covered
92090	Full Covered	92194	Full Covered	92399	Mostly Covered	92625	Full Covered	92835	Full Covered	93110	Full Covered
92091	Full Covered	92195	Full Covered	92401	Full Covered	92626	Full Covered	92836	Full Covered	93111	Mostly Covered
92092	Full Covered	92196	Full Covered	92402	Full Covered	92627	Full Covered	92837	Full Covered	93116	Mostly Covered
92093	Full Covered	92197	Full Covered	92403	Full Covered	92628	Full Covered	92838	Full Covered	93117	Full Covered
92096	Full Covered	92198	Full Covered	92404	Full Covered	92629	Mostly Covered	92840	Full Covered	93118	Mostly Covered
92101	Full Covered	92199	Full Covered	92405	Full Covered	92630	Full Covered	92841	Full Covered	93120	Full Covered
92102	Full Covered	92201	Full Covered	92406	Full Covered	92637	Full Covered	92842	Full Covered	93121	Full Covered
92103	Full Covered	92202	Full Covered	92407	Full Covered	92646	Full Covered	92843	Full Covered	93130	Full Covered
92104	Full Covered	92203	Full Covered	92408	Full Covered	92647	Full Covered	92844	Full Covered	93140	Full Covered
92105	Full Covered	92210	Mostly Covered	92410	Full Covered	92648	Full Covered	92845	Full Covered	93150	Full Covered
92106	Full Covered	92211	Full Covered	92411	Full Covered	92649	Full Covered	92846	Full Covered	93160	Mostly Covered
92107	Full Covered	92220	Full Covered	92412	Full Covered	92650	Full Covered	92850	Full Covered	93190	Full Covered
92108	Full Covered	92222	Mostly Covered	92413	Full Covered	92651	Full Covered	92856	Full Covered	93199	Mostly Covered
92109	Full Covered	92223	Full Covered	92414	Full Covered	92652	Full Covered	92857	Full Covered	93202	Mostly Covered
92110	Full Covered	92227	Full Covered	92415	Full Covered	92653	Full Covered	92859	Full Covered	93210	Full Covered
92111	Full Covered	92230	Full Covered	92418	Full Covered	92654	Full Covered	92860	Mostly Covered	93220	Full Covered
92112	Full Covered	92231	Mostly Covered	92420	Full Covered	92655	Full Covered	92861	Full Covered	93221	Mostly Covered
92113	Full Covered	92232	Full Covered	92423	Full Covered	92656	Full Covered	92862	Full Covered	93223	Mostly Covered
92114	Full Covered	92234	Full Covered	92424	Full Covered	92657	Full Covered	92863	Full Covered	93224	Mostly Covered
92115	Full Covered	92235	Full Covered	92427	Full Covered	92658	Full Covered	92864	Full Covered	93227	Mostly Covered
92116	Full Covered	92236	Mostly Covered	92501	Full Covered	92659	Full Covered	92865	Full Covered	93230	Mostly Covered
92117	Full Covered	92240	Mostly Covered	92502	Full Covered	92660	Full Covered	92866	Full Covered	93232	Full Covered
92118	Full Covered	92241	Full Covered	92504	Mostly Covered	92661	Full Covered	92867	Full Covered	93237	Mostly Covered
92119	Full Covered	92243	Full Covered	92505	Mostly Covered	92662	Full Covered	92868	Full Covered	93241	Mostly Covered
92120	Full Covered	92244	Full Covered	92506	Full Covered	92663	Full Covered	92869	Full Covered	93242	Full Covered
92121	Full Covered	92249	Full Covered	92507	Full Covered	92672	Full Covered	92870	Full Covered	93244	Full Covered
92122	Full Covered	92250	Mostly Covered	92508	Full Covered	92673	Full Covered	92871	Full Covered	93247	Mostly Covered
92123	Full Covered	92251	Mostly Covered	92509	Mostly Covered	92674	Full Covered	92877	Full Covered	93252	Full Covered
92124	Full Covered	92253	Mostly Covered	92514	Mostly Covered	92675	Mostly Covered	92878	Full Covered	93257	Full Covered
92126	Full Covered	92255	Mostly Covered	92516	Full Covered	92676	Full Covered	92879	Mostly Covered	93258	Full Covered
92127	Full Covered	92258	Full Covered	92517	Full Covered	92677	Full Covered	92880	Full Covered	93263	Full Covered
92128	Full Covered	92260	Mostly Covered	92518	Full Covered	92678	Full Covered	92881	Mostly Covered	93267	Full Covered
92129	Full Covered	92261	Mostly Covered	92519	Mostly Covered	92679	Full Covered	92882	Full Covered	93268	Full Covered
92130	Full Covered	92262	Mostly Covered	92521	Full Covered	92683	Full Covered	92883	Full Covered	93270	Mostly Covered
92131	Full Covered	92263	Mostly Covered	92522	Full Covered	92684	Full Covered	92885	Mostly Covered	93271	Mostly Covered
92132	Full Covered	92264	Mostly Covered	92530	Mostly Covered	92685	Full Covered	92886	Mostly Covered	93272	Mostly Covered
92133	Full Covered	92267	Full Covered	92531	Mostly Covered	92688	Full Covered	92887	Full Covered	93274	Full Covered

Zip Code	Coverage Level	Zip Code	Coverage Level	Zip Code	Coverage Level	Zip Code	Coverage Level	Zip Code	Coverage Level	Zip Code	Coverage Level
94704	Full Covered	95014	Full Covered	95160	Full Covered	95377	Full Covered	95630	Full Covered	95841	Full Covered
94705	Full Covered	95015	Full Covered	95161	Full Covered	95378	Mostly Covered	95632	Full Covered	95842	Full Covered
94706	Full Covered	95018	Full Covered	95164	Full Covered	95379	Mostly Covered	95633	Mostly Covered	95843	Full Covered
94707	Full Covered	95019	Mostly Covered	95170	Full Covered	95380	Full Covered	95637	Full Covered	95851	Full Covered
94708	Full Covered	95024	Mostly Covered	95172	Full Covered	95381	Full Covered	95639	Mostly Covered	95852	Full Covered
94709	Full Covered	95026	Mostly Covered	95173	Full Covered	95382	Full Covered	95641	Full Covered	95853	Full Covered
94710	Full Covered	95030	Full Covered	95190	Full Covered	95385	Mostly Covered	95648	Mostly Covered	95860	Full Covered
94712	Full Covered	95031	Full Covered	95191	Full Covered	95388	Full Covered	95650	Full Covered	95864	Full Covered
94720	Full Covered	95032	Full Covered	95192	Full Covered	95401	Mostly Covered	95651	Mostly Covered	95865	Full Covered
94801	Full Covered	95033	Mostly Covered	95193	Full Covered	95402	Full Covered	95652	Full Covered	95866	Full Covered
94802	Full Covered	95035	Full Covered	95194	Full Covered	95403	Mostly Covered	95653	Mostly Covered	95867	Full Covered
94803	Full Covered	95036	Full Covered	95196	Full Covered	95404	Full Covered	95655	Full Covered	95887	Full Covered
94804	Full Covered	95041	Full Covered	95201	Full Covered	95405	Full Covered	95656	Mostly Covered	95894	Full Covered
94805	Full Covered	95042	Full Covered	95202	Full Covered	95406	Mostly Covered	95658	Full Covered	95899	Full Covered
94806	Full Covered	95044	Mostly Covered	95203	Full Covered	95407	Mostly Covered	95659	Mostly Covered	95916	Full Covered
94807	Full Covered	95045	Full Covered	95204	Full Covered	95408	Mostly Covered	95660	Full Covered	95924	Full Covered
94808	Full Covered	95050	Full Covered	95205	Full Covered	95409	Full Covered	95661	Full Covered	95926	Full Covered
94820	Full Covered	95051	Full Covered	95206	Mostly Covered	95416	Full Covered	95662	Full Covered	95927	Full Covered
94850	Full Covered	95052	Full Covered	95207	Full Covered	95418	Mostly Covered	95663	Full Covered	95928	Full Covered
94875	Full Covered	95053	Full Covered	95208	Full Covered	95419	Full Covered	95664	Full Covered	95929	Full Covered
94901	Full Covered	95054	Full Covered	95209	Full Covered	95426	Mostly Covered	95667	Full Covered	95937	Full Covered
94903	Full Covered	95055	Full Covered	95210	Full Covered	95430	Full Covered	95668	Full Covered	95938	Full Covered
94904	Full Covered	95056	Full Covered	95211	Full Covered	95431	Full Covered	95670	Full Covered	95940	Mostly Covered
94912	Full Covered	95060	Mostly Covered	95212	Full Covered	95433	Full Covered	95671	Full Covered	95946	Mostly Covered
94913	Full Covered	95061	Full Covered	95213	Full Covered	95435	Mostly Covered	95672	Full Covered	95948	Mostly Covered
94914	Full Covered	95062	Full Covered	95215	Mostly Covered	95436	Mostly Covered	95673	Full Covered	95949	Full Covered
94915	Full Covered	95063	Full Covered	95219	Mostly Covered	95439	Mostly Covered	95677	Full Covered	95950	Mostly Covered
94920	Full Covered	95064	Full Covered	95220	Full Covered	95442	Full Covered	95678	Full Covered	95951	Mostly Covered
94922	Full Covered	95065	Full Covered	95229	Mostly Covered	95444	Full Covered	95680	Full Covered	95953	Full Covered
94923	Mostly Covered	95066	Full Covered	95231	Full Covered	95452	Full Covered	95682	Full Covered	95957	Mostly Covered
94924	Full Covered	95067	Full Covered	95234	Mostly Covered	95453	Mostly Covered	95683	Full Covered	95958	Mostly Covered
94925	Full Covered	95070	Full Covered	95237	Mostly Covered	95461	Full Covered	95686	Full Covered	95965	Mostly Covered
94926	Full Covered	95071	Full Covered	95240	Mostly Covered	95465	Mostly Covered	95687	Mostly Covered	95966	Mostly Covered
94927	Mostly Covered	95073	Full Covered	95241	Full Covered	95472	Full Covered	95688	Full Covered	95967	Full Covered
94928	Full Covered	95075	Mostly Covered	95242	Mostly Covered	95473	Full Covered	95690	Full Covered	95969	Full Covered
94929	Mostly Covered	95076	Mostly Covered	95247	Mostly Covered	95476	Full Covered	95691	Full Covered	95973	Mostly Covered
94930	Full Covered	95101	Full Covered	95251	Mostly Covered	95481	Mostly Covered	95693	Mostly Covered	95975	Full Covered
94931	Full Covered	95102	Full Covered	95253	Full Covered	95482	Mostly Covered	95696	Full Covered	95976	Full Covered
94933	Full Covered	95103	Full Covered	95258	Full Covered	95485	Mostly Covered	95703	Mostly Covered	95982	Full Covered
94938	Full Covered	95106	Full Covered	95267	Full Covered	95487	Full Covered	95709	Mostly Covered	96001	Full Covered
94939	Full Covered	95108	Full Covered	95269	Full Covered	95493	Mostly Covered	95712	Mostly Covered	96002	Full Covered
94940	Mostly Covered	95109	Full Covered	95290	Full Covered	95501	Full Covered	95713	Mostly Covered	96003	Full Covered
94941	Full Covered	95110	Full Covered	95296	Full Covered	95502	Full Covered	95722	Mostly Covered	96007	Full Covered
94942	Full Covered	95111	Full Covered	95297	Full Covered	95503	Full Covered	95736	Mostly Covered	96019	Full Covered
94945	Full Covered	95112	Full Covered	95298	Full Covered	95518	Full Covered	95741	Full Covered	96022	Full Covered
94946	Full Covered	95113	Full Covered	95304	Full Covered	95519	Mostly Covered	95742	Full Covered	96049	Full Covered
94947	Full Covered	95114	Full Covered	95307	Full Covered	95521	Full Covered	95746	Mostly Covered	96073	Mostly Covered
94948	Full Covered	95115	Full Covered	95309	Full Covered	95524	Full Covered	95747	Full Covered	96079	Full Covered
94949	Full Covered	95116	Full Covered	95310	Full Covered	95534	Full Covered	95758	Full Covered	96087	Full Covered
94950	Full Covered	95117	Full Covered	95315	Mostly Covered	95536	Mostly Covered	95759	Full Covered	96089	Full Covered
94951	Full Covered	95118	Full Covered	95316	Mostly Covered	95537	Full Covered	95762	Full Covered	96095	Mostly Covered
94952	Mostly Covered	95119	Mostly Covered	95319	Full Covered	95540	Mostly Covered	95763	Full Covered	96099	Full Covered
94953	Full Covered	95120	Full Covered	95320	Mostly Covered	95547	Mostly Covered	95765	Full Covered	96140	Full Covered
94954	Full Covered	95121	Full Covered	95324	Mostly Covered	95551	Mostly Covered	95776	Mostly Covered	96142	Mostly Covered
94955	Full Covered	95122	Full Covered	95325	Mostly Covered	95558	Mostly Covered	95798	Full Covered	96143	Full Covered
94957	Full Covered	95123	Full Covered	95326	Full Covered	95562	Full Covered	95799	Full Covered	96145	Full Covered
94960	Full Covered	95124	Full Covered	95327	Mostly Covered	95564	Full Covered	95812	Full Covered	96146	Full Covered
94963	Full Covered	95125	Full Covered	95328	Full Covered	95565	Full Covered	95813	Full Covered	96148	Full Covered
94964	Full Covered	95126	Full Covered	95330	Mostly Covered	95602	Full Covered	95814	Full Covered	96150	Full Covered
94965	Full Covered	95127	Full Covered	95336	Full Covered	95603	Full Covered	95815	Full Covered	96151	Full Covered
94966	Full Covered	95128	Full Covered	95337	Full Covered	95604	Full Covered	95816	Full Covered	96152	Full Covered
94970	Full Covered	95129	Full Covered	95340	Mostly Covered	95605	Full Covered	95817	Full Covered	96154	Full Covered
94971	Full Covered	95130	Full Covered	95341	Mostly Covered	95606	Full Covered	95818	Full Covered	96156	Full Covered
94972	Full Covered	95131	Full Covered	95344	Full Covered	95607	Full Covered	95819	Full Covered	96157	Full Covered
94973	Full Covered	95132	Full Covered	95347	Mostly Covered	95608	Full Covered	95820	Full Covered	96158	Full Covered
94974	Full Covered	95133	Full Covered	95348	Full Covered	95609	Full Covered	95821	Full Covered	96160	Full Covered
94975	Full Covered	95134	Full Covered	95350	Full Covered	95610	Full Covered	95822	Full Covered	96161	Full Covered
94976	Full Covered	95136	Full Covered	95351	Full Covered	95611	Full Covered	95823	Full Covered	96701	Full Covered
94977	Full Covered	95137	Full Covered	95352	Full Covered	95612	Mostly Covered	95824	Full Covered	96703	Mostly Covered
94978	Full Covered	95138	Mostly Covered	95353	Full Covered	95613	Full Covered	95825	Full Covered	96704	Full Covered
94979	Full Covered	95139	Mostly Covered	95354	Full Covered	95614	Mostly Covered	95826	Full Covered	96705	Full Covered
94998	Full Covered	95141	Full Covered	95355	Full Covered	95615	Full Covered	95827	Full Covered	96706	Full Covered
94999	Full Covered	95142	Full Covered	95356	Full Covered	95616	Full Covered	95828	Full Covered	96707	Full Covered
95001	Mostly Covered	95148	Full Covered	95357	Full Covered	95617	Full Covered	95829	Full Covered	96708	Full Covered
95002	Mostly Covered	95150	Full Covered	95358	Full Covered	95618	Full Covered	95830	Full Covered	96709	Full Covered
95003	Full Covered	95151	Full Covered	95365	Mostly Covered	95619	Full Covered	95831	Full Covered	96712	Full Covered
95005	Full Covered	95152	Full Covered	95366	Full Covered	95620	Full Covered	95832	Full Covered	96713	Mostly Covered
95006	Full Covered	95153	Full Covered	95367	Full Covered	95621	Full Covered	95833	Full Covered	96714	Full Covered
95007	Full Covered	95154	Full Covered	95368	Full Covered	95623	Mostly Covered	95834	Full Covered	96715	Full Covered
95008	Full Covered	95155	Full Covered	95369	Full Covered	95624	Full Covered	95835	Full Covered	96716	Full Covered
95009	Full Covered	95156	Full Covered	95370	Full Covered	95625	Mostly Covered	95836	Full Covered	96717	Full Covered
95010	Full Covered	95157	Full Covered	95372	Mostly Covered	95626	Full Covered	95837	Full Covered	96718	Mostly Covered
95011	Full Covered	95158	Full Covered	95373	Full Covered	95627	Mostly Covered	95838	Full Covered	96719	Full Covered
95013	Mostly Covered	95159	Full Covered	95376	Mostly Covered	95628	Full Covered	95840	Full Covered	96720	Mostly Covered

Zip Code	Coverage Level	Zip Code	Coverage Level	Zip Code	Coverage Level	Zip Code	Coverage Level	Zip Code	Coverage Level	Zip Code	Coverage Level
96721	Full Covered	96827	Full Covered	97214	Full Covered	97408	Mostly Covered	98092	Full Covered	98235	Full Covered
96722	Full Covered	96828	Full Covered	97215	Full Covered	97420	Mostly Covered	98093	Full Covered	98236	Full Covered
96725	Mostly Covered	96830	Full Covered	97216	Full Covered	97426	Mostly Covered	98101	Full Covered	98238	Full Covered
96726	Full Covered	96835	Full Covered	97217	Full Covered	97440	Full Covered	98102	Full Covered	98239	Mostly Covered
96727	Full Covered	96836	Full Covered	97218	Full Covered	97455	Full Covered	98103	Full Covered	98240	Full Covered
96728	Mostly Covered	96837	Full Covered	97219	Full Covered	97472	Mostly Covered	98104	Full Covered	98247	Mostly Covered
96729	Full Covered	96838	Full Covered	97220	Full Covered	97477	Full Covered	98105	Full Covered	98248	Mostly Covered
96730	Full Covered	96839	Full Covered	97221	Full Covered	97478	Mostly Covered	98106	Full Covered	98257	Mostly Covered
96731	Full Covered	96840	Full Covered	97222	Full Covered	97482	Full Covered	98107	Full Covered	98258	Full Covered
96732	Full Covered	96841	Full Covered	97223	Full Covered	97501	Full Covered	98108	Full Covered	98259	Full Covered
96733	Full Covered	96842	Full Covered	97224	Mostly Covered	97502	Full Covered	98109	Full Covered	98260	Full Covered
96734	Full Covered	96843	Full Covered	97225	Full Covered	97504	Mostly Covered	98111	Full Covered	98262	Full Covered
96738	Full Covered	96844	Full Covered	97227	Full Covered	97525	Mostly Covered	98112	Full Covered	98264	Mostly Covered
96739	Full Covered	96846	Full Covered	97228	Full Covered	97527	Mostly Covered	98113	Full Covered	98270	Full Covered
96740	Full Covered	96847	Full Covered	97229	Full Covered	97528	Full Covered	98114	Full Covered	98271	Full Covered
96741	Full Covered	96848	Full Covered	97230	Full Covered	97533	Mostly Covered	98115	Full Covered	98272	Full Covered
96743	Full Covered	96849	Full Covered	97231	Mostly Covered	97535	Mostly Covered	98116	Full Covered	98273	Full Covered
96744	Full Covered	96850	Full Covered	97232	Full Covered	97701	Full Covered	98117	Full Covered	98274	Full Covered
96745	Full Covered	96853	Full Covered	97233	Full Covered	97702	Full Covered	98118	Full Covered	98275	Full Covered
96746	Full Covered	96854	Full Covered	97236	Full Covered	97708	Full Covered	98119	Full Covered	98276	Mostly Covered
96747	Full Covered	96857	Full Covered	97238	Full Covered	97709	Full Covered	98121	Full Covered	98277	Full Covered
96749	Full Covered	96858	Full Covered	97239	Full Covered	98001	Full Covered	98122	Full Covered	98278	Full Covered
96750	Mostly Covered	96859	Full Covered	97240	Full Covered	98002	Full Covered	98124	Full Covered	98279	Mostly Covered
96751	Full Covered	96860	Full Covered	97242	Full Covered	98003	Full Covered	98125	Full Covered	98287	Full Covered
96752	Full Covered	96861	Full Covered	97251	Full Covered	98004	Full Covered	98126	Full Covered	98290	Full Covered
96753	Mostly Covered	96862	Full Covered	97253	Full Covered	98005	Full Covered	98127	Full Covered	98291	Full Covered
96754	Full Covered	96863	Full Covered	97254	Full Covered	98006	Full Covered	98129	Full Covered	98292	Full Covered
96755	Full Covered	96898	Full Covered	97255	Full Covered	98007	Full Covered	98131	Full Covered	98296	Full Covered
96756	Full Covered	97002	Mostly Covered	97258	Full Covered	98008	Full Covered	98132	Full Covered	98303	Full Covered
96757	Mostly Covered	97005	Full Covered	97266	Full Covered	98009	Full Covered	98133	Mostly Covered	98310	Mostly Covered
96759	Full Covered	97006	Full Covered	97267	Full Covered	98010	Mostly Covered	98134	Full Covered	98311	Mostly Covered
96760	Full Covered	97007	Mostly Covered	97268	Full Covered	98011	Full Covered	98136	Full Covered	98312	Full Covered
96761	Full Covered	97008	Full Covered	97269	Full Covered	98012	Full Covered	98138	Full Covered	98314	Mostly Covered
96762	Full Covered	97009	Full Covered	97271	Full Covered	98013	Mostly Covered	98139	Full Covered	98323	Mostly Covered
96765	Full Covered	97013	Full Covered	97280	Full Covered	98014	Mostly Covered	98141	Full Covered	98325	Mostly Covered
96766	Full Covered	97015	Full Covered	97281	Full Covered	98015	Full Covered	98144	Full Covered	98327	Full Covered
96767	Full Covered	97024	Full Covered	97282	Full Covered	98020	Full Covered	98145	Full Covered	98328	Mostly Covered
96768	Full Covered	97027	Full Covered	97283	Full Covered	98021	Full Covered	98146	Full Covered	98329	Mostly Covered
96770	Full Covered	97030	Full Covered	97286	Full Covered	98023	Full Covered	98148	Full Covered	98333	Mostly Covered
96771	Mostly Covered	97032	Mostly Covered	97290	Full Covered	98025	Full Covered	98151	Full Covered	98335	Mostly Covered
96772	Full Covered	97034	Full Covered	97291	Full Covered	98026	Full Covered	98154	Full Covered	98337	Mostly Covered
96778	Full Covered	97035	Full Covered	97292	Full Covered	98027	Full Covered	98155	Full Covered	98338	Mostly Covered
96779	Full Covered	97036	Full Covered	97293	Full Covered	98028	Full Covered	98158	Full Covered	98344	Full Covered
96781	Mostly Covered	97045	Mostly Covered	97294	Full Covered	98029	Full Covered	98160	Mostly Covered	98351	Mostly Covered
96782	Full Covered	97048	Full Covered	97296	Full Covered	98030	Full Covered	98161	Full Covered	98352	Full Covered
96783	Mostly Covered	97054	Full Covered	97298	Full Covered	98031	Full Covered	98164	Full Covered	98354	Full Covered
96784	Full Covered	97058	Mostly Covered	97299	Full Covered	98032	Full Covered	98165	Full Covered	98360	Full Covered
96785	Full Covered	97060	Full Covered	97301	Full Covered	98033	Full Covered	98166	Full Covered	98362	Mostly Covered
96786	Full Covered	97062	Full Covered	97302	Full Covered	98034	Full Covered	98168	Full Covered	98367	Mostly Covered
96788	Full Covered	97068	Full Covered	97303	Mostly Covered	98035	Full Covered	98170	Full Covered	98368	Full Covered
96789	Full Covered	97070	Full Covered	97304	Mostly Covered	98036	Full Covered	98171	Full Covered	98371	Full Covered
96790	Full Covered	97075	Full Covered	97305	Full Covered	98037	Full Covered	98174	Full Covered	98372	Full Covered
96791	Full Covered	97076	Full Covered	97306	Full Covered	98038	Full Covered	98175	Full Covered	98373	Full Covered
96792	Full Covered	97077	Full Covered	97307	Full Covered	98039	Full Covered	98177	Mostly Covered	98374	Mostly Covered
96793	Full Covered	97078	Full Covered	97308	Full Covered	98040	Full Covered	98178	Full Covered	98375	Mostly Covered
96795	Full Covered	97080	Full Covered	97309	Full Covered	98041	Full Covered	98181	Full Covered	98376	Mostly Covered
96796	Full Covered	97102	Mostly Covered	97310	Full Covered	98042	Mostly Covered	98184	Full Covered	98378	Mostly Covered
96797	Full Covered	97107	Full Covered	97311	Full Covered	98043	Full Covered	98185	Full Covered	98380	Mostly Covered
96801	Full Covered	97110	Full Covered	97312	Full Covered	98046	Full Covered	98188	Full Covered	98382	Mostly Covered
96802	Full Covered	97113	Mostly Covered	97313	Full Covered	98047	Full Covered	98190	Full Covered	98383	Mostly Covered
96803	Full Covered	97115	Full Covered	97314	Full Covered	98050	Full Covered	98191	Full Covered	98385	Full Covered
96804	Full Covered	97118	Full Covered	97322	Mostly Covered	98051	Mostly Covered	98194	Full Covered	98388	Full Covered
96805	Full Covered	97123	Full Covered	97325	Mostly Covered	98052	Full Covered	98195	Full Covered	98390	Full Covered
96806	Full Covered	97127	Mostly Covered	97327	Mostly Covered	98053	Full Covered	98198	Full Covered	98393	Mostly Covered
96807	Full Covered	97132	Full Covered	97335	Mostly Covered	98054	Full Covered	98199	Full Covered	98396	Mostly Covered
96808	Full Covered	97134	Full Covered	97336	Mostly Covered	98055	Full Covered	98201	Full Covered	98401	Full Covered
96809	Full Covered	97137	Mostly Covered	97351	Full Covered	98056	Full Covered	98203	Full Covered	98402	Full Covered
96810	Full Covered	97140	Full Covered	97352	Full Covered	98057	Full Covered	98204	Full Covered	98403	Full Covered
96811	Full Covered	97143	Full Covered	97355	Mostly Covered	98058	Full Covered	98205	Full Covered	98404	Full Covered
96812	Full Covered	97145	Full Covered	97359	Mostly Covered	98059	Full Covered	98206	Full Covered	98405	Full Covered
96813	Full Covered	97146	Mostly Covered	97365	Full Covered	98061	Mostly Covered	98207	Full Covered	98406	Full Covered
96814	Full Covered	97201	Full Covered	97366	Full Covered	98062	Full Covered	98208	Full Covered	98407	Full Covered
96815	Full Covered	97202	Full Covered	97369	Full Covered	98063	Full Covered	98213	Full Covered	98408	Full Covered
96816	Full Covered	97203	Full Covered	97371	Mostly Covered	98064	Full Covered	98221	Mostly Covered	98409	Full Covered
96817	Full Covered	97204	Full Covered	97376	Mostly Covered	98070	Mostly Covered	98222	Mostly Covered	98411	Full Covered
96818	Full Covered	97205	Full Covered	97377	Mostly Covered	98071	Full Covered	98225	Full Covered	98412	Full Covered
96819	Full Covered	97206	Full Covered	97389	Mostly Covered	98072	Full Covered	98226	Full Covered	98413	Full Covered
96820	Full Covered	97207	Full Covered	97391	Mostly Covered	98073	Full Covered	98227	Full Covered	98415	Full Covered
96821	Full Covered	97208	Full Covered	97392	Mostly Covered	98074	Full Covered	98228	Full Covered	98416	Full Covered
96822	Full Covered	97209	Full Covered	97401	Full Covered	98075	Full Covered	98229	Full Covered	98418	Full Covered
96823	Full Covered	97210	Full Covered	97402	Mostly Covered	98077	Mostly Covered	98230	Full Covered	98421	Full Covered
96824	Full Covered	97211	Full Covered	97403	Full Covered	98082	Full Covered	98231	Full Covered	98422	Full Covered
96825	Full Covered	97212	Full Covered	97404	Full Covered	98083	Full Covered	98232	Mostly Covered	98424	Full Covered
96826	Full Covered	97213	Full Covered	97405	Full Covered	98089	Full Covered	98233	Full Covered	98430	Full Covered

Zip Code	Coverage Level	Zip Code	Coverage Level	Zip Code	Coverage Level	Zip Code	Coverage Level	Zip Code	Coverage Level	Zip Code	Coverage Level
98431	Full Covered	98505	Full Covered	98625	Mostly Covered	98907	Full Covered	99217	Full Covered	99514	Full Covered
98433	Full Covered	98506	Full Covered	98626	Mostly Covered	98908	Mostly Covered	99218	Full Covered	99515	Full Covered
98438	Full Covered	98507	Full Covered	98628	Mostly Covered	98909	Full Covered	99220	Full Covered	99517	Full Covered
98439	Mostly Covered	98508	Full Covered	98635	Full Covered	98920	Mostly Covered	99223	Full Covered	99518	Full Covered
98442	Full Covered	98509	Full Covered	98660	Mostly Covered	98933	Mostly Covered	99228	Full Covered	99519	Full Covered
98443	Full Covered	98511	Full Covered	98661	Mostly Covered	98939	Full Covered	99251	Full Covered	99520	Full Covered
98444	Full Covered	98512	Full Covered	98662	Mostly Covered	98944	Mostly Covered	99252	Full Covered	99521	Mostly Covered
98445	Full Covered	98513	Full Covered	98663	Mostly Covered	98951	Full Covered	99256	Full Covered	99522	Full Covered
98446	Mostly Covered	98516	Full Covered	98664	Mostly Covered	99005	Mostly Covered	99258	Full Covered	99523	Full Covered
98447	Full Covered	98522	Full Covered	98665	Mostly Covered	99021	Mostly Covered	99260	Full Covered	99524	Full Covered
98450	Full Covered	98528	Mostly Covered	98666	Mostly Covered	99036	Mostly Covered	99299	Full Covered	99567	Mostly Covered
98455	Full Covered	98532	Full Covered	98667	Full Covered	99037	Mostly Covered	99320	Mostly Covered	99599	Full Covered
98460	Full Covered	98537	Mostly Covered	98668	Mostly Covered	99164	Mostly Covered	99324	Full Covered	99629	Full Covered
98464	Full Covered	98538	Full Covered	98670	Full Covered	99201	Full Covered	99336	Mostly Covered	99654	Mostly Covered
98465	Full Covered	98540	Full Covered	98671	Mostly Covered	99202	Full Covered	99352	Full Covered	99695	Full Covered
98466	Full Covered	98556	Mostly Covered	98673	Mostly Covered	99203	Full Covered	99353	Full Covered	99703	Full Covered
98467	Full Covered	98557	Mostly Covered	98675	Mostly Covered	99204	Full Covered	99362	Full Covered	99706	Mostly Covered
98471	Full Covered	98558	Mostly Covered	98682	Full Covered	99205	Full Covered	99501	Full Covered	99707	Full Covered
98477	Full Covered	98565	Mostly Covered	98683	Full Covered	99206	Full Covered	99502	Mostly Covered	99708	Full Covered
98481	Full Covered	98579	Mostly Covered	98684	Full Covered	99207	Full Covered	99503	Full Covered	99710	Full Covered
98492	Full Covered	98593	Mostly Covered	98687	Full Covered	99208	Mostly Covered	99504	Mostly Covered	99711	Mostly Covered
98493	Full Covered	98596	Mostly Covered	98801	Full Covered	99209	Full Covered	99506	Full Covered	99716	Mostly Covered
98497	Full Covered	98599	Full Covered	98802	Full Covered	99210	Full Covered	99507	Full Covered	99775	Mostly Covered
98498	Full Covered	98604	Mostly Covered	98807	Full Covered	99211	Full Covered	99508	Full Covered	99802	Full Covered
98499	Full Covered	98606	Full Covered	98828	Mostly Covered	99212	Full Covered	99509	Full Covered	99803	Mostly Covered
98501	Full Covered	98607	Full Covered	98836	Mostly Covered	99213	Full Covered	99510	Full Covered	99811	Full Covered
98502	Mostly Covered	98609	Full Covered	98902	Full Covered	99214	Full Covered	99511	Full Covered	99824	Full Covered
98503	Full Covered	98613	Mostly Covered	98903	Mostly Covered	99215	Full Covered	99512	Full Covered	99850	Mostly Covered
98504	Full Covered	98617	Full Covered	98904	Mostly Covered	99216	Mostly Covered	99513	Full Covered		



LG Electronics Inc.

LG Twin Tower, 20, Yoido-Dong,
Youngdungpo-Gu, Seoul, 150-721, Korea.
<http://www.lge.com>